



**HAL**  
open science

## **PAMPRE and the Chemistry of Neutral Species in Titan's Upper Atmosphere**

David Dubois, Nathalie Carrasco, Sarah Tigrine, Ludovic Vettier, Guy Cernogora

► **To cite this version:**

David Dubois, Nathalie Carrasco, Sarah Tigrine, Ludovic Vettier, Guy Cernogora. PAMPRE and the Chemistry of Neutral Species in Titan's Upper Atmosphere. Exobiologie Jeunes Chercheurs 2015, Nov 2015, Paris, France. 2015. insu-01336838

**HAL Id: insu-01336838**

**<https://insu.hal.science/insu-01336838>**

Submitted on 24 Jun 2016

**HAL** is a multi-disciplinary open access archive for the deposit and dissemination of scientific research documents, whether they are published or not. The documents may come from teaching and research institutions in France or abroad, or from public or private research centers.

L'archive ouverte pluridisciplinaire **HAL**, est destinée au dépôt et à la diffusion de documents scientifiques de niveau recherche, publiés ou non, émanant des établissements d'enseignement et de recherche français ou étrangers, des laboratoires publics ou privés.



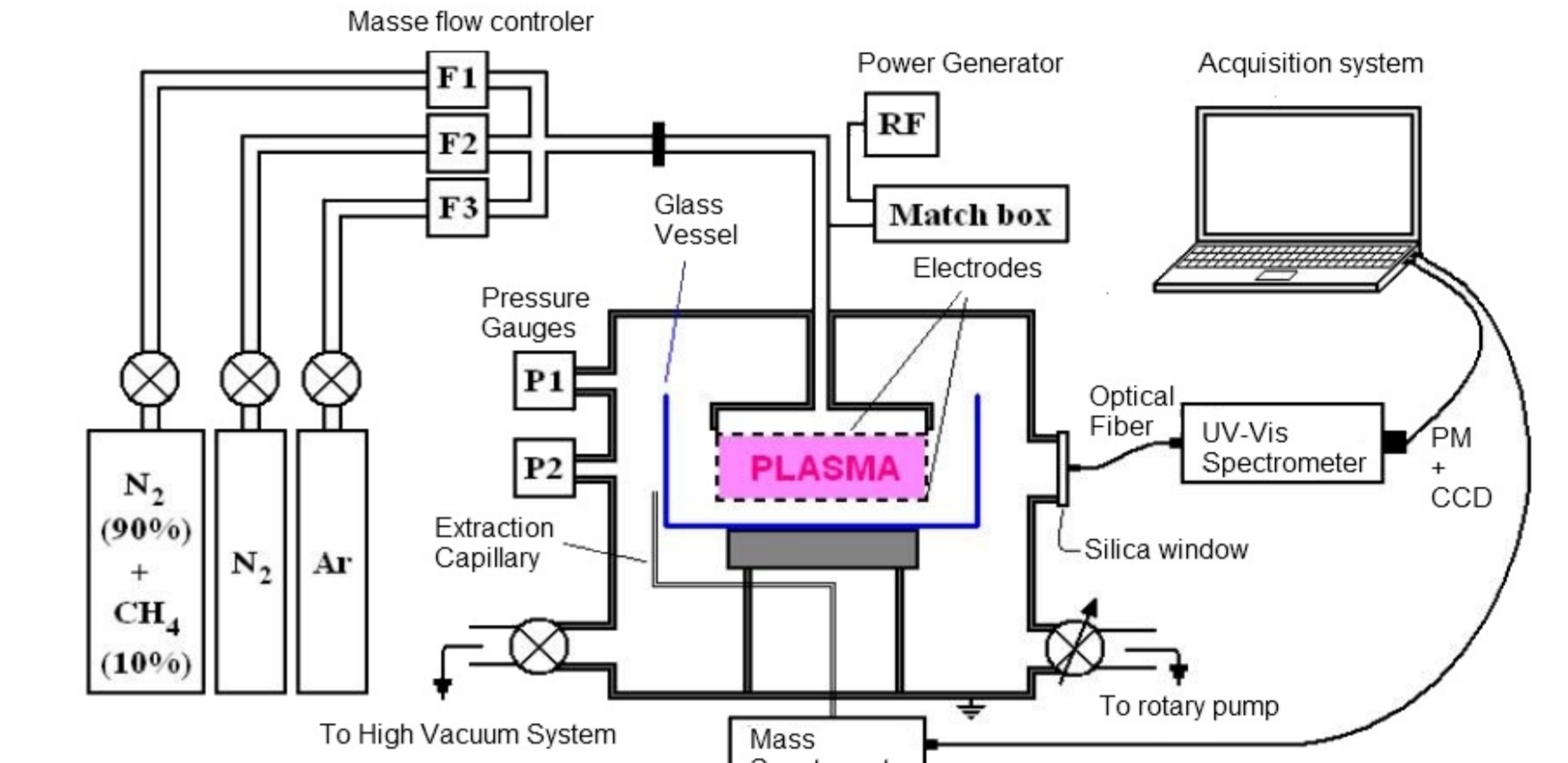
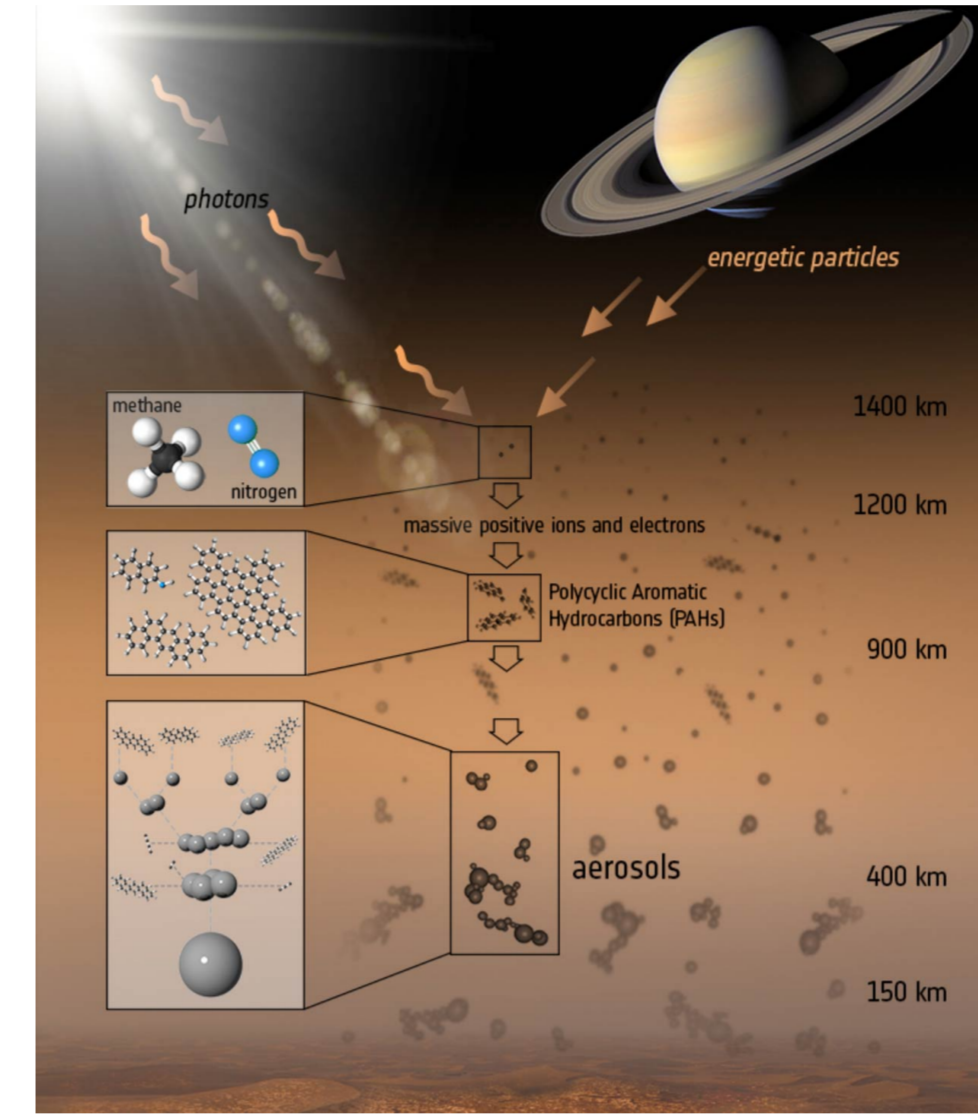
# PAMPRE and the Chemistry of Neutral Species in Titan's Upper Atmosphere

D. Dubois, N. Carrasco, S. Tigrine, L. Vettier, G. Cernogora  
Université Versailles St-Quentin, UPMC Univ. Paris 06, CNRS, LATMOS, 11 Blvd. d'Alembert, 78280 Guyancourt, France

## [1] Abstract

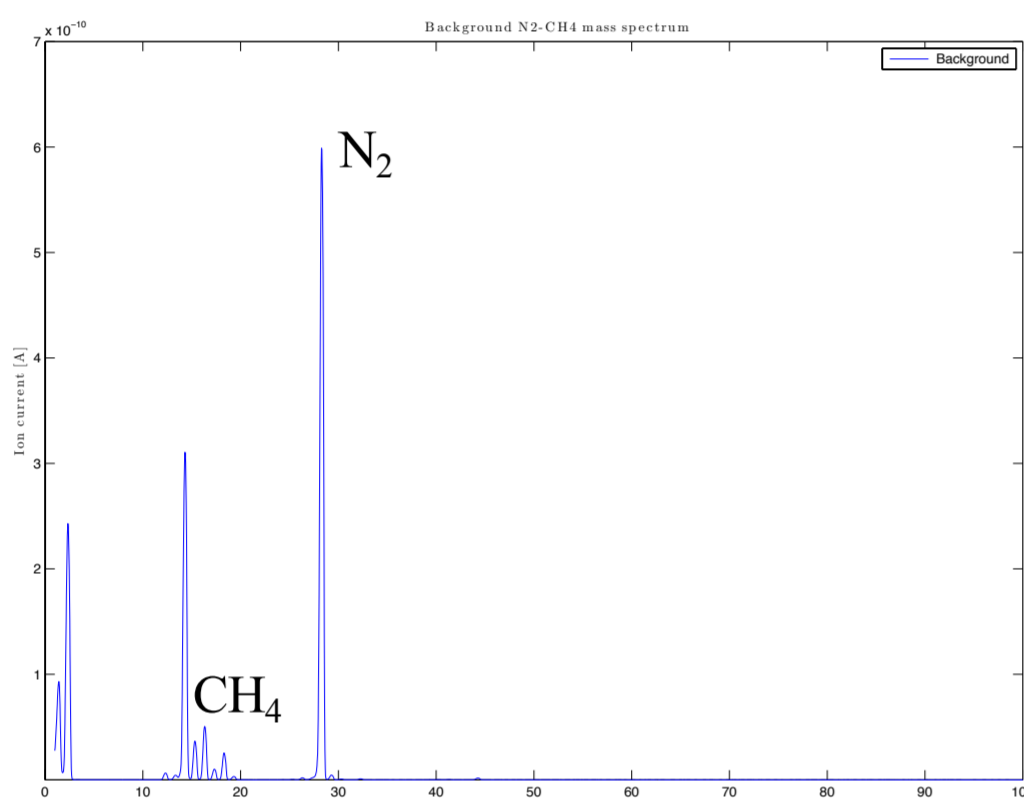
A complex atmospheric photochemistry has been revealed in Titan's atmosphere by the ongoing Cassini-Huygens mission. Its composition mainly made out of  $N_2$ - $CH_4$  leads to ionization and photo-dissociative processes that eventually form solid organic aerosols called tholins. Tholins are assumed to be formed in the ionosphere, where they coexist with the gas phase, in an ionic and neutral medium. The PAMPRE set-up aims at simulating the reactivity and production of solid aerosols in Titan's ionospheric conditions through heterogeneous chemistry in a radiofrequency-induced plasma. In this study, our aim was to accumulate gas products in an  $N_2$ - $CH_4$  (90-10%) mixture using a cold trap to retain the products. These were then released after end of cooling and analyzed with infrared spectroscopy and mass spectrometry in order to better understand the chemical reactivity at work.

## [2] Introduction

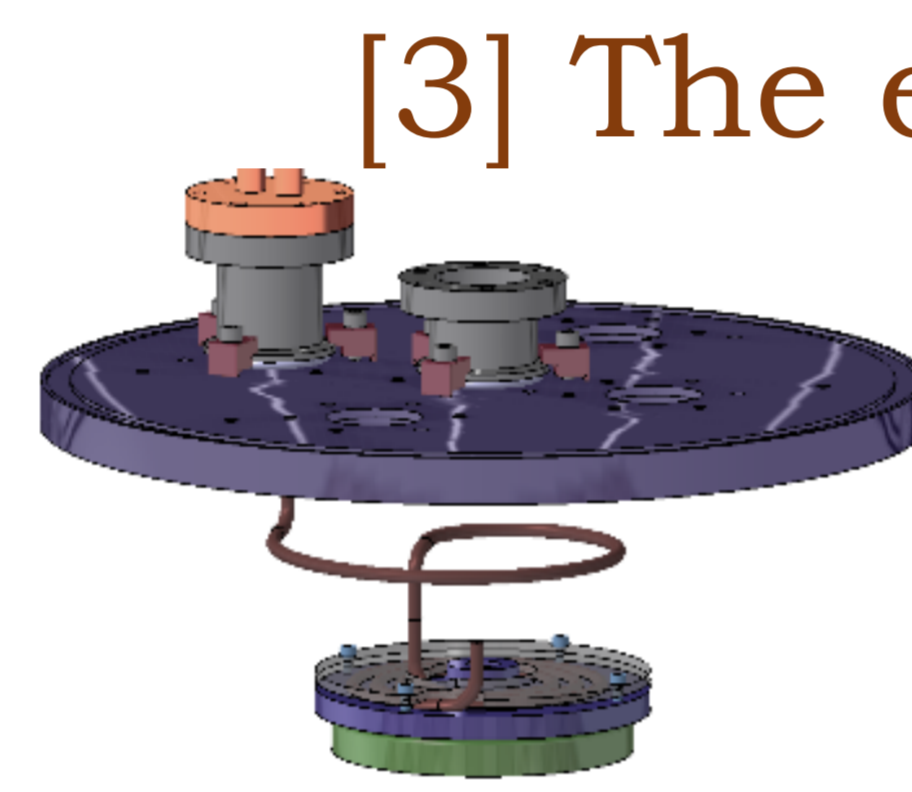


**Fig. 2.** The PAMPRE RF plasma experiment (Szopa et al., 2006)

**Fig. 1.** The intense photochemistry leading up to the formation of aerosols that make up the hazy layers on Titan. Image credit: ESA/ATG medialab



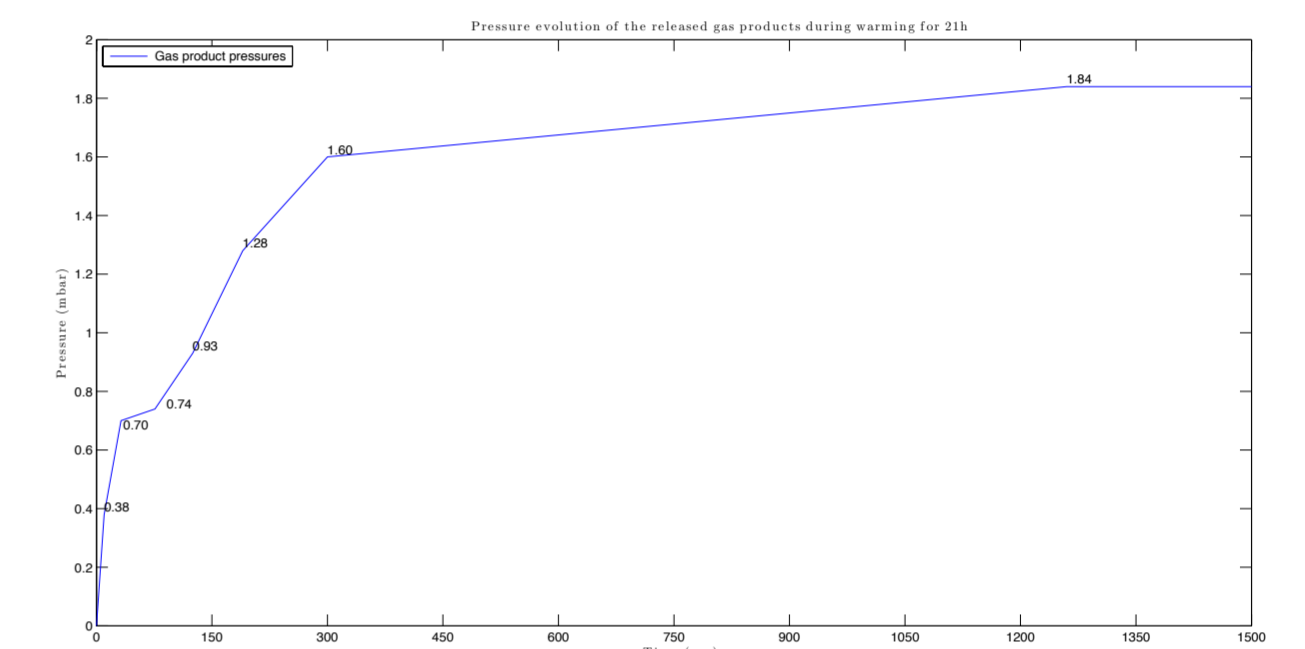
**Fig. 3.** Background mass spectrum



**Fig. 4.** The cryogenic trap system

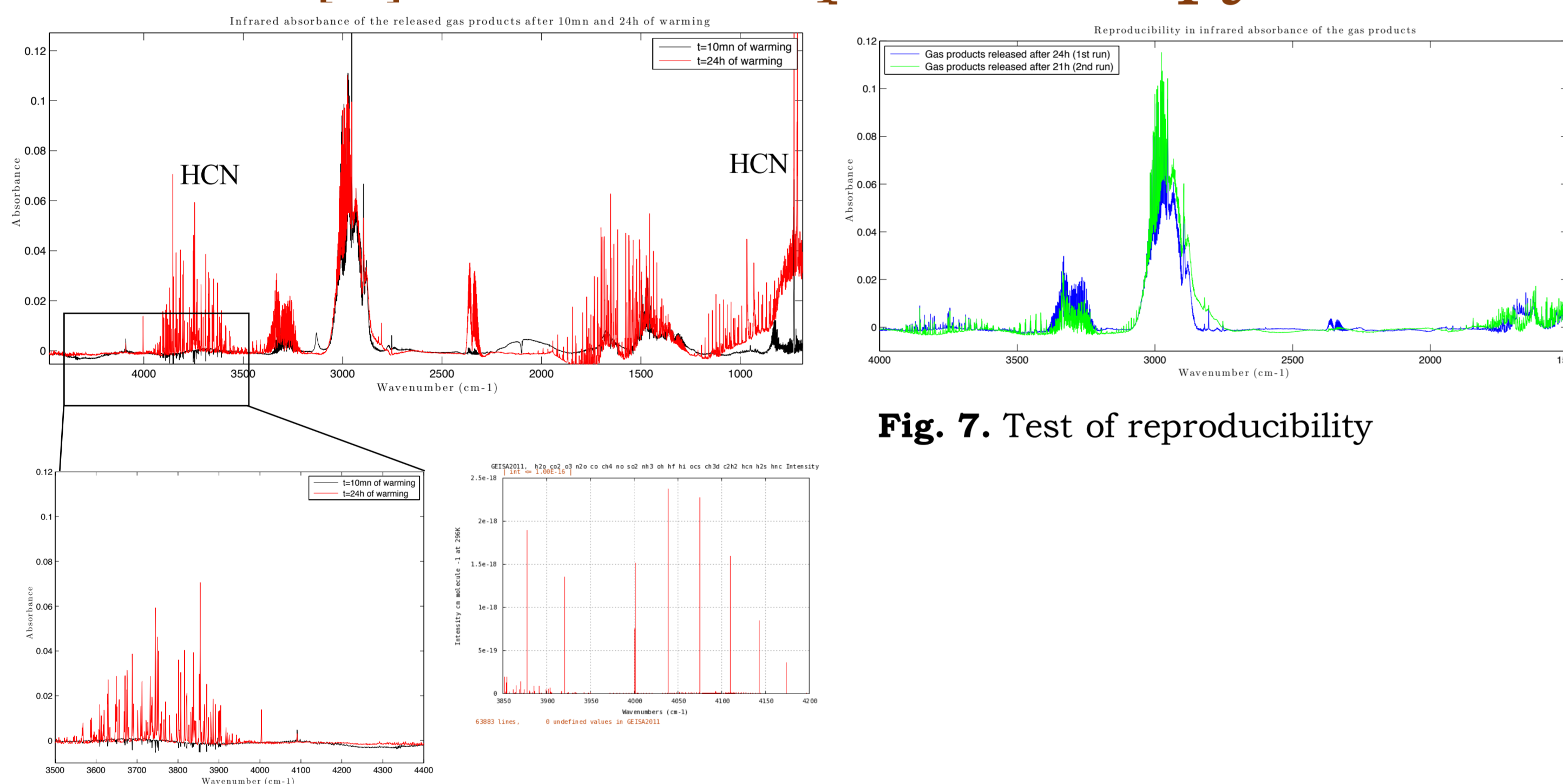
## [3] The experiment

- The cryogenic trap was set at a temperature of  $T^{\circ} = 100$  K in order to try and trap as many products as possible



**Fig. 5.** Pressure evolution of the gas products released after end of cooling

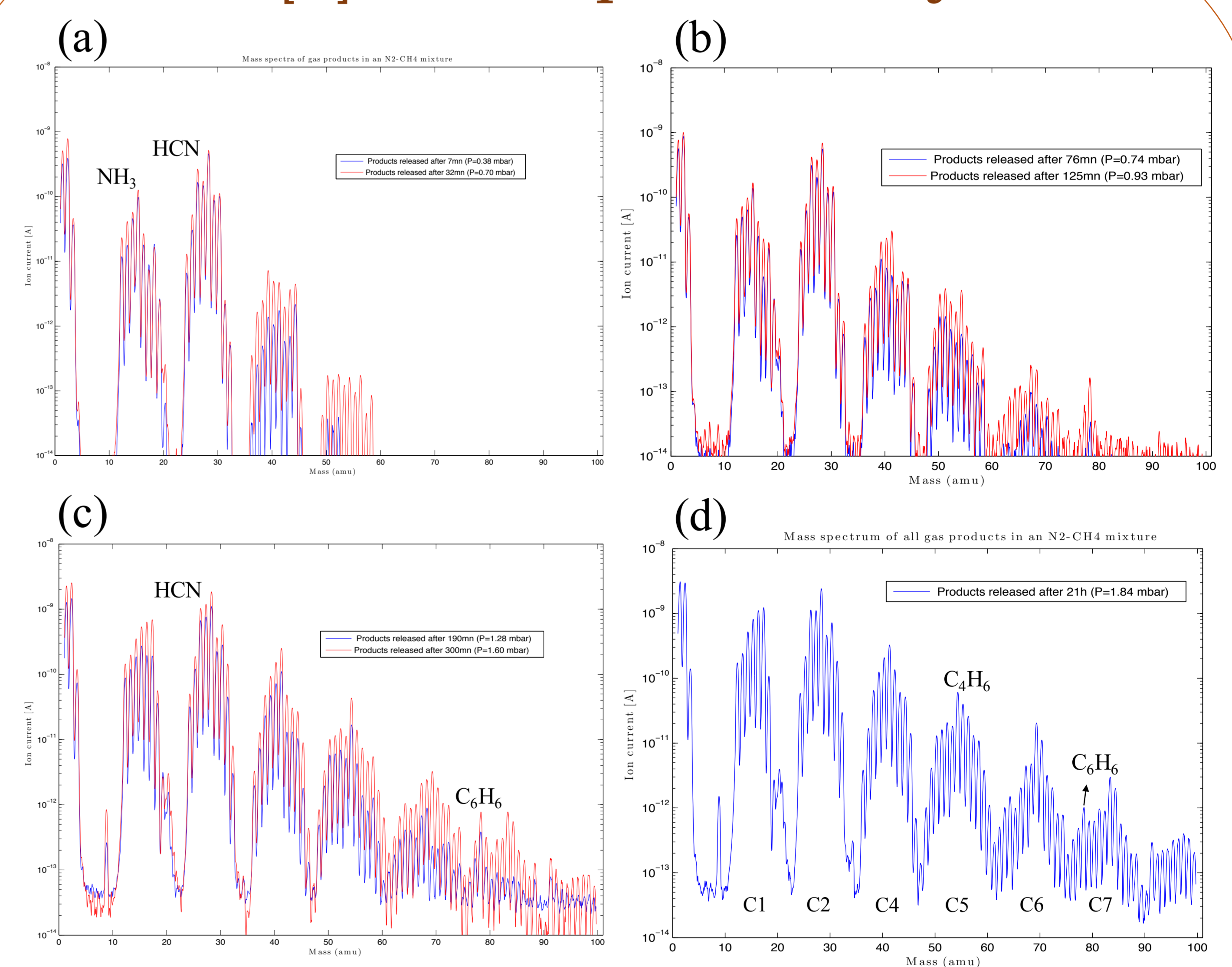
## [4] Infrared Spectroscopy



**Fig. 6.** Infrared absorption of the gas products released after cryogenic trap, with zoom centered at  $4000\text{ cm}^{-1}$ , compared with the GEISA spectroscopy database

**Fig. 7.** Test of reproducibility

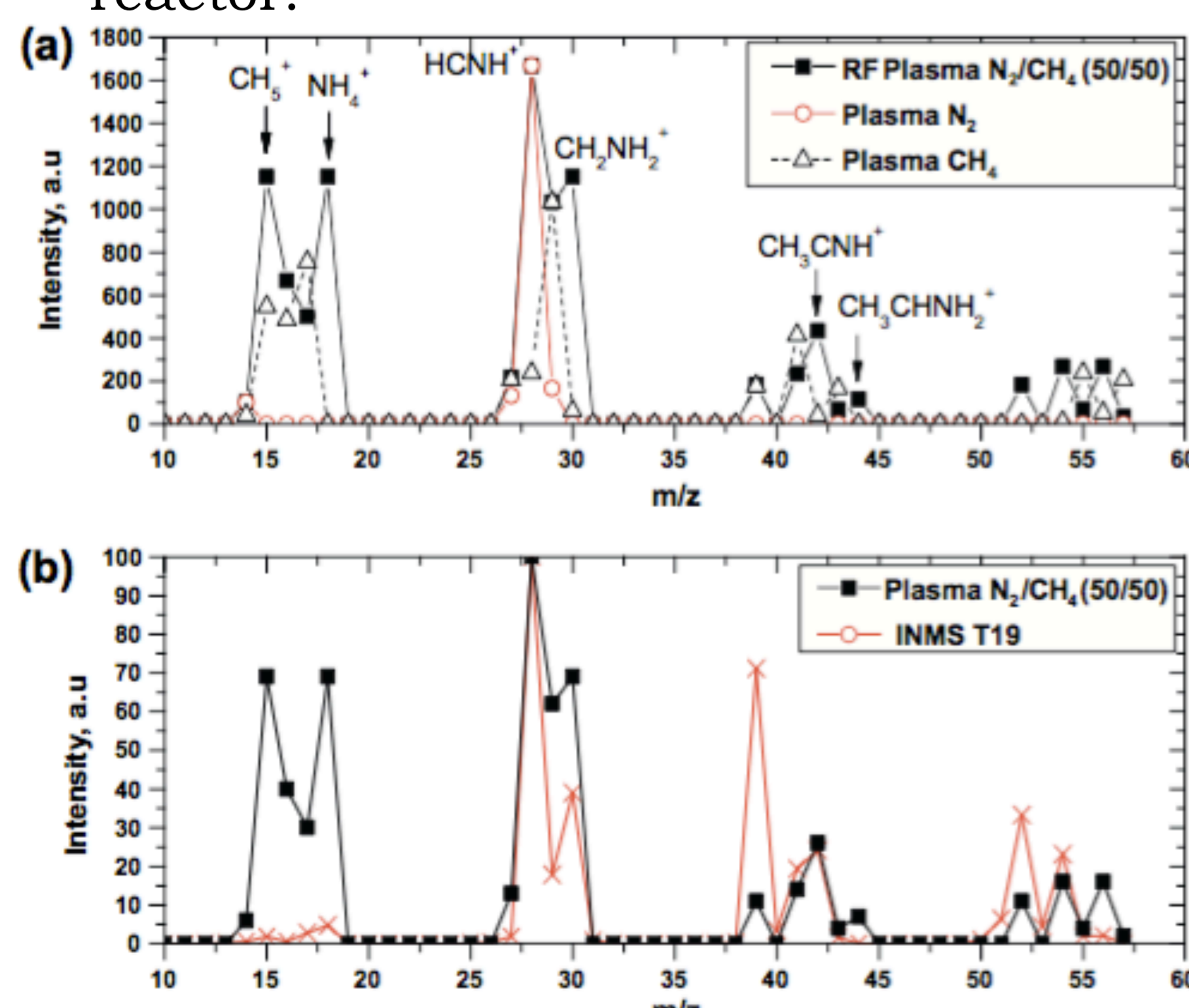
## [5] Mass Spectrometry



**Fig. 8.** Gas products released after 32mn (a), 125mn (b), 300mn (c) and 21h (d). The final pressure of gas products attained here is 1.84 mbar. For the first 32mn, C1 and C2 molecules are already well present. C3 and C4 compounds appear after 76mn. C5, C6 and higher mass molecules are detectable back at room temperature, at the end of our experiment.

## [6] Perspectives

- In light of this study of neutral species, the next step will be to analyze positive and negative ions by secondary ion mass spectrometry coupled with the reactor.



**Fig. 9.** (a) Ion mass spectra measured in an RF plasma (adapted from Mutsukura, 2001) (b) Qualitative comparison of positive ions in an RF plasma and in Titan's ionosphere (Carrasco et al., 2012)

- Data provided by the INMS instrument onboard Cassini showed the prevalence of ion chemistry leading to the formation of the tholins (Mandt et al., 2012).

## References

- Cable, M., Hörst, S., Hodyss, R., Beauchamp, P., Smith, M., Willis, P., 2011. Titan Tholins: Simulating Titan Organic Chemistry in the Cassini-Huygens Era, *Chem. Rev.*, 112, 1882-1909.
- Carrasco, N., Gautier, T., Es-sebbar, E., Pernot, P., Cernogora, G., 2012. Volatile products controlling Titan's tholins production. *Icarus* 219, 230-240.
- Mandt, K., et al., 2012. Ion densities and composition of Titan's upper atmosphere, *JGR*, 117, E10006.
- Mutsukura, N., 2001. Deposition of diamondlike carbon film and mass spectrometry measurement in  $CH_4/N_2$  RF plasma. *Plasma Chem. Plasma Process.* 21, 265-277.
- Szopa, C., Cernogora, G., Boufendi, L., Correia, J.-J., Coll, P., 2006. PAMPRE: A dusty plasma experiment for Titan's tholins production and study. *Planetary and Space Science*, 54, 394-404.