



HAL
open science

Continuous gravity recording with Scintrex CG-3M meters: a promising tool for monitoring active zones

Sylvain Bonvalot, Michel Diament, Germinal Gabalda

► To cite this version:

Sylvain Bonvalot, Michel Diament, Germinal Gabalda. Continuous gravity recording with Scintrex CG-3M meters: a promising tool for monitoring active zones. *Geophysical Journal International*, 1998, 135 (2), pp.470-494. 10.1046/j.1365-246X.1998.00653.x . insu-01354070

HAL Id: insu-01354070

<https://insu.hal.science/insu-01354070v1>

Submitted on 17 Aug 2016

HAL is a multi-disciplinary open access archive for the deposit and dissemination of scientific research documents, whether they are published or not. The documents may come from teaching and research institutions in France or abroad, or from public or private research centers.

L'archive ouverte pluridisciplinaire **HAL**, est destinée au dépôt et à la diffusion de documents scientifiques de niveau recherche, publiés ou non, émanant des établissements d'enseignement et de recherche français ou étrangers, des laboratoires publics ou privés.

Continuous gravity recording with Scintrex CG-3M meters: a promising tool for monitoring active zones

Sylvain Bonvalot,^{1,2} Michel Diament² and Germinal Gabalda¹

¹ORSTOM, Laboratoire de Géophysique, 32 Avenue Varagnat, 93143 Bondy Cedex, France. E-mail: bonvalot@bondy.orstom.fr

²Institut de Physique du Globe, Laboratoire de Gravimétrie et Géodynamique, 4 Pl. Jussieu, 75252 Paris, France

Accepted 1998 June 16. Received 1998 June 12; in original form 1997 November 10

SUMMARY

We acquired continuous series of microgravity measurements using several Scintrex CG-3M gravity meters for several weeks in 1997. The meters with 1 μGal resolution were installed side by side in a stable reference station at the ORSTOM research centre to perform identical data acquisition. We present and compare the instrumental responses obtained for the various gravity meters (measurement series of gravity field, standard deviation, internal temperature, tilts) and analyse their correlation with simultaneous recordings of meteorological parameters. The data have been processed in order to (1) establish the mid- to long-term relative stability and the accuracy of the instruments, (2) estimate the contribution of instrumental effects to gravity data measurements and (3) quantify the amplitude of the time variations of the gravity field that might be detected with such instruments.

This study emphasizes the sensitivity of some instrumental responses of the Scintrex CG-3M gravity meters (such as internal temperature or tilt) to local atmospheric-pressure variations. This sensitivity can lead to non-negligible perturbations of the gravity measurements through automatic corrections applied in real-time mode by the integrated software. We show that most of these instrumental artefacts can be easily removed in data post-processing by using simultaneous atmospheric-pressure data. After removal of an accurate Earth tide model, the instrumental drift and the instrumental effects, the temporal series are compared by computing differential signals. These residual signals obtained over a period of several weeks exhibit the following characteristics: (1) the gravity residuals have a maximum amplitude ranging from 5 to 10 μGal and from 10 to 15 μGal for filtered and unfiltered data, respectively; and (2) the standard error, tilts and internal temperature measurements of the various gravity meters are very consistent; their respective residual amplitudes are $\pm 2 \mu\text{Gal}$, $\pm 3 \text{ arcsec}$ and $\pm 0.05 \text{ mK}$.

In order to calibrate the gravity meters precisely in the measurement range used in this study, we have measured a calibration line established in the framework of the fourth intercomparison of absolute and relative gravity meters. This calibration was achieved with an accuracy of 5 μGal . This result is consistent with other field tests already performed with such gravity meters. In addition, we also checked the accuracy of the tilt sensors by increasing the electronic read-out by a factor of 10. The tilt response of the whole gravity meter to a small induced inclinometric variation indicates that the precision of the tilt measurements is about a few tenths of an arc second.

This study reveals that temporal variations of the gravity field could potentially be detected in the field with an accuracy of about 5–15 μGal by permanent networks of Scintrex CG-3M gravity meters set up a few kilometres apart. This result is of particular interest in field surveys of temporal gravity changes related to some environmental or geodynamical processes, where the expected gravity variations are greater than a few tens of μGal . In particular, in volcanological applications, the continuous monitoring of active volcanoes with such permanent networks of gravity meters co-located with subcentimetre-accuracy GPS receivers should be very helpful to understand internal

magmatic processes better and to detect possible gravity and inclinometric signals occurring during pre-eruptive phases. In this field, continuous microgravity recordings associated with classical reiteration networks will probably improve hazard mitigation in the near future.

Key words: gravity meter, microgravity, Scintrex CG-3, volcano monitoring.

1 INTRODUCTION

The study of the time variations of the Earth's gravity field can provide fundamental information on the internal dynamics of the globe at different scales and also on some meteorological phenomena (Lambeck 1981; Goodkind 1986; Torge 1981; Hinderer, Legros & Crossley 1991; Groten & Becker 1995). Depending on their origin, these variations occur over long or short periods of time, periodically or temporarily. They are detected by repeated relative or absolute measurements made at reference stations for the long-term phenomena, and by continuous measurements for the short-term phenomena. These studies rely on highly accurate observations that currently can be performed under laboratory-like conditions with the use of absolute gravity meters or superconducting relative gravimeters, whose resolution can reach 0.1–1 μGal (1 μGal = 10 nm s^{-2}). Such accuracy cannot be obtained in the field because of the instrumental limitation on one hand (field instruments are more robust, more portable but less accurate), and because of a greater exposure to external perturbations of the measurement sites (meteorological effects, microseismic activity, etc.) on the other hand. However, temporal gravity changes of relatively large amplitude (greater than a few tens of μGal) can be studied under local conditions on tectonically active or volcanic zones. Recent instrument-technological developments in microgravimetry and in related domains such as GPS geodesy now allow us to acquire more easily a larger amount and higher quality of field data (higher sensor accuracy, numerical data acquisition and processing, higher storage capabilities, etc.). Nowadays, these improvements allow us to detect and to study phenomena of smaller amplitudes or occurring over shorter periods, for which the resolution limit of the instruments can be reached. A good knowledge of the instrument responses and of the various factors that can influence the data quality is then indispensable in order to evaluate the actual accuracy of the measurements and, therefore, the order of magnitude of the observable phenomena.

As an example, temporal gravity studies in tectonically active or volcanic zones require at the same time very accurate instruments and well-defined data acquisition and processing procedures, in order to minimize the various error sources and to reach the required accuracy. Regarding the microgravity monitoring of active volcanoes, these methodological aspects as well as numerous examples of applications have been discussed in publications presenting the state of the art in this domain (Rymer & Brown 1986; Tilling 1989; Eggers 1987; Berrino *et al.* 1992; Rymer 1994, 1995). These temporal gravity variations are related to changes in the internal structure of the systems (mass redistribution, density changes) or to ground motions (altitude change of the measurement site) in response to a magmatic activity. After removal of the component due to a possible deformation of the topographic surface, the

amplitude of the residual gravity variations ranges from several tens to several hundreds of μGal . The observed variations are usually episodic and occur shortly before or after phases of volcanic activity. The study of these variations for which microgravity methods are more and more often used, is of particular interest for the monitoring of volcanoes. In addition, a volcanic eruption precursor signal was clearly pointed out for the first time on the Poas volcano (Costa Rica) in 1989 (Rymer & Brown 1989).

Temporal gravity variations on volcanoes are usually detected by repeated measurements. Microgravimetric and geodetic networks, with stations located in stable zones as well as in active zones, are used for these measurements. The time interval at which the networks are reoccupied, typically from several weeks to several years, allows the recording and the study of long-period variations which are related to long-term magmatic phenomena. In order to detect shorter-term variations, either the networks should be occupied more often or continuous recordings of the gravity field should be made. A few time-series have been acquired on several active volcanoes in this way: for example, on Etna, Italy (Berrino *et al.* 1995; De Meyer, Ducarme & Elwahabi 1995; Budetta, Carbone & Rymer, personal communication) and on Merapi, Indonesia (Jousset *et al.* in press). Some of these time-series showed a correlation between the gravity field variations and the magmatic or seismic activity. Most of the time, these data have been acquired at a single site with only one instrument. Therefore, it is difficult to connect the data with certitude to the various events, because of limiting factors such as the small numbers of time-series, too short a period of recording, and the importance of instrumental effects. In order to avoid some of these shortcomings, the optimal method would consist in deploying permanent networks of microgravimeters distributed over the active zone and over a stable zone used as a reference. This method has several advantages for volcanic monitoring, including:

- (1) a more accurate analysis of the time variations that could lead to a possible detection of eruption precursors;
- (2) a continuous recording of the data even during the active periods, limiting the risks for the operators;
- (3) a diminution of the number of in-field tasks (network reoccupations) and automation of the monitoring tasks.

So far, in-field microgravity surveys and the above-mentioned type of continuous series on volcanoes have mainly been realized with relative gravimeters of the LaCoste & Romberg type, whose resolution varies from 10 to 5 μGal for the G and D models, respectively (LaCoste & Romberg 1991). Many studies have confirmed the accuracy and the stability of these instruments for the detection of gravity field variations in active zones. The accuracy obtained by reoccupying the networks with such instruments usually varies from 15 to

20 μGal (Rymer 1989, 1994; Torge 1989). These instruments can also be equipped with an automatic system of measurement which allows the continuous recording of analog or digital data. A model with a limited range of measurement of 12 or 14 mGal (ET model) was especially created for Earth tide studies (LaCoste & Romberg 1996). These different models of gravimeter (D, G and ET types) could also be modified by integrating an electronic feedback system with the original sensor (Harrison & Sato 1984; Van Ruymbeke 1985; Vaillant 1986). Under good conditions, the accuracy of the Earth tide recordings made on these instruments is estimated to be 0.5 or 1 μGal , on the basis of the standard deviations defined for the hourly values (Torge 1989, p. 378). These observations confirm that the technical characteristics of the LaCoste & Romberg instruments are well suited to the continuous monitoring of volcanoes, although these instruments were developed a few decades ago.

A new generation of relative gravimeters was conceived by Scintrex Ltd at the end of the 1980s. The AutoGrav CG-3 and CG-3M meters are based on the use of microprocessors, which allowed the automation of the measurements and their processing (Hugill 1990). These instruments, with resolutions of 5 μGal and 1 μGal , respectively, can be used in two different modes: an in-field mode allowing the acquisition of discrete measurements, and a cycling mode for continuous data recording. Their technical characteristics make these instruments useful for various applications of relative gravimetry based on the study of the spatial and temporal variations of the gravity field. Therefore, they can also be used in microgravity studies in volcanology, for discrete measurements as well as for continuous recordings. Several recent studies have confirmed the potentialities of these instruments for the micro-gravimetric survey of superficial structures and for network

reoccupation on several active volcanoes: Masaya (Bonvalot *et al.* 1995); Piton de la Fournaise (Bonvalot *et al.* 1996; Diament *et al.* 1997), Merapi (Diament *et al.* 1995; Jousset 1996), La Soufrière (Diament *et al.* 1997); Etna (Budetta & Carbone 1997), for instance.

At present, there is no published study of continuous recordings of the time variations due to geodynamic effects (seismic or volcanic active zones) using the Scintrex CG-3/3M recording system. Nevertheless, the instrument is particularly well suited to this field of application. Therefore, a comparative study has been carried out on several instruments with microgal sensitivity in order to check the middle- and long-term behaviour and stability of the Scintrex CG-3M gravimeter responses. Continuous recordings have been acquired on the same site in order to analyse the influence of the instrumental effects on each device and to evaluate the expected accuracy for this type of study.

2 THE SCINTREX CG-3/3M GRAVITY METER

2.1 Functional principle

The measurement of the gravity field in this instrument is based on a capacitive measurement of the extension of a vertical quartz spring. This geodetic-type device allows a worldwide measurement of the gravity field over a range of 7000 mGal without resetting. Currently, its resolution reaches 5 μGal for the standard version (CG-3 model) and 1 μGal for the microgal version (CG-3M model). At a given station, the gravity field relative value is determined by a series of measurements (generally 60–120 single measurements) performed at a sampling rate of 1 Hz. The mean value and its standard deviation are

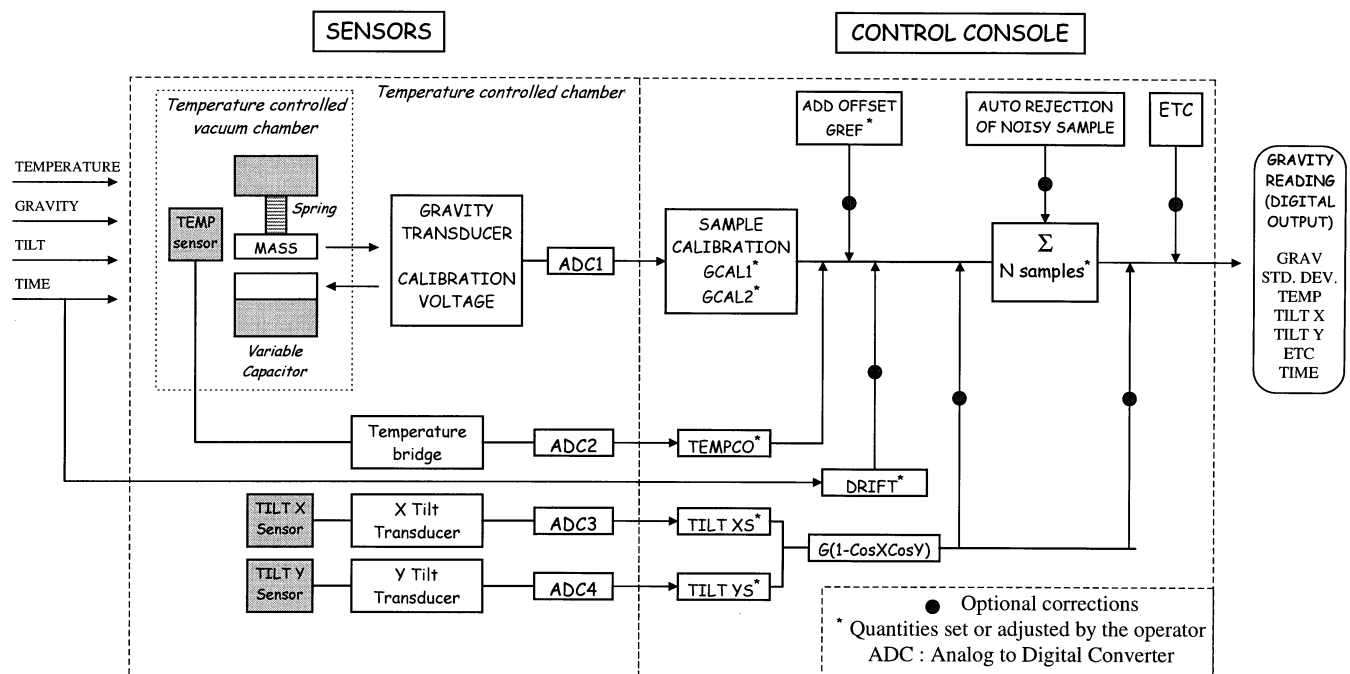

Figure 1. Simplified acquisition scheme for the Scintrex CG-3/3M gravimeter (modified from Scintrex 1995). *ETC* is the software-computed Earth tide correction based on the Longman (1959) algorithm. The parameters *TILT XS* and *TILT YS* are the tilt sensor sensitivities adjusted by the operator (see text). *TEMPCO* is the temperature correction factor determined by the manufacturer (see text). *GCAL1* and *GCAL2* are the first- and second-order calibration factors of the gravity signal and *DRIFT* is the correction factor used for the instrumental linear drift correction.

computed from the single measurements after rejecting outliers. In addition, this instrument is equipped with tilt and internal temperature sensors, providing real-time numerical corrections of the gravity measurements. These corrections are applied for a range of internal temperature of ± 2 mK and for a range of tilt of ± 200 arcsec. Then, the numerical data are stored internally and can be transferred to a computer through an RS232 port. Fig. 1 shows a diagram of the data acquisition and processing system. Technical details of the instrument and the acquisition procedures can be found in Hugill (1990), Scintrex (1995) and Siegel, Brcic & Mistry (1993).

The Scintrex CG-3/3M gravimeter can be operated either in field mode or in cycling mode. Depending on the operating mode, data acquisition is triggered either by an operator, once the meter has been installed temporarily, or automatically at a pre-defined sample rate (typically starting from 1 point min^{-1}), for a fixed device. These modes allow for measurements of both spatial and temporal variations of the gravity field.

2.2 Main domains of application

The main purpose of this instrument is for measurements in geophysical prospecting (gravimetric and microgravimetric measurements in oil and mining prospecting, civil engineering, etc.). Several real-time acquisition and processing procedures have been included by the manufacturer to increase the speed and efficiency of the data collection, and to ease the post-processing of the data (theoretical correction for the lunar-solar tide applied for a given latitude, removal of the long-term instrumental drift determined by continuous recording, etc.). This meter can also be used for continuous measurements of the Earth's gravity field. Ducarme & Somerhausen (1997) recently analysed the Earth tide recorded in Brussels by a CG-3M gravimeter over an eight-month period of time. Despite a strong instrumental drift (a few tenths of a mGal day^{-1}) and a relatively low resolution for this type of study, the results, as well as a comparison with other gravimeters (LaCoste & Romberg, GWR superconducting), confirm that this instrument is also suitable for Earth tide studies. Other applications involving the measurement of time variations observed at a local scale, such as in active seismic or volcanic zones, can be also envisaged. The performances of the Scintrex CG-3/3M gravimeters have been compared to those of other relative gravimeters usually used for such purposes (LaCoste & Romberg type). Examples include the fourth intercalibration

of absolute and relative gravimeters (Jousset *et al.* 1995) and field measurement results (Budetta & Carbone 1997). These studies have shown that a repeatability of the measurement of the order of 5–10 μGal could be obtained with these instruments on network measurements. Such results have also been recently confirmed by another comparison of LaCoste & Romberg and Scintrex meters (Kauffmann & Doll, in press).

3 IMPLEMENTATION OF CONTINUOUS RECORDING

3.1 Methodological aspects and study objectives

Various methodological aspects of time variation studies using continuous recording have been tackled by Goodkind (1986). Time-series acquired from superconducting gravimeters were analysed to point out and to interpret the residual variations observed after Earth tide and instrumental-drift corrections had been applied. Such residual variations can be related to geophysical, instrumental or atmospheric factors. In order to determine the precise cause of these variations, it is first necessary to look for a possible correlation between the gravity observations and other parameters simultaneously recorded. In particular, the analysis of the correlation should allow one to discriminate between the variations related to external factors (meteorological, geodynamic) and the variations due to instrumental effects (internal temperature, tilt). In consequence, the identification of instrumental artefacts is a fundamental step in the analysis of gravity field continuous recordings. Indeed, the amplitudes of these instrumental effects are comparable to or greater than those of the actual signals.

Goodkind (1986) has also shown the advantage of using several instruments of the same type in order to make simultaneous recordings of the gravity field. This approach is the only rigorous way to determine the instrumental noise limits and the instrumental drift. By running at least two meters at the same site, their relative stability can be assessed and controlled periodically. Then, the meters can be operated at remote sites. Differential recordings can allow the detection of time variations with a previously determined accuracy. Another benefit of this method is to eliminate some of the local gravity variations that are not correlated with instrumental effects. For instance, this is the case for uncorrected Earth tide periodic residuals or for local variations of the atmospheric pressure. Both can be minimized by the computation of differential

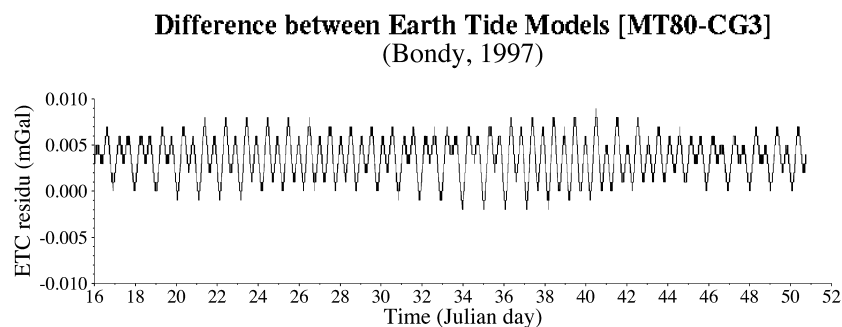

Figure 2. Difference between two theoretical models of the Earth tide between 01/16/97 and 02/20/97 at ORSTOM Research Centre in Bondy (48.915°N, 2.486°E). The residual signal is the difference between the correction computed by the Scintrex CG3 software [Longman (1959) algorithm] and the correction computed using the amplitude and phase coefficients determined by the Royal Observatory of Belgium (MT80 software).

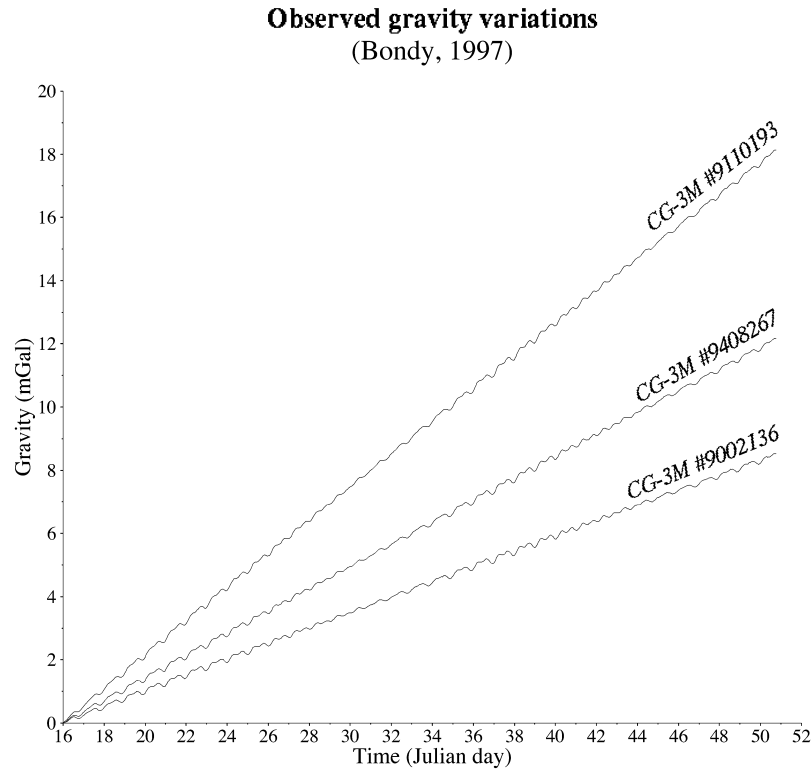

Figure 3. Raw gravity recordings acquired on several Scintrex CG-3M gravimeters side by side (Bondy, from 01/16/97 to 02/20/97) with no internal drift correction applied. The data acquired at a time interval of 2 min, were undersampled at a sampling rate of 1 point hr^{-1} . The drift and offset parameters were set to zero in order to quantify their actual instrumental drift.

Table 1. Instrumental parameters for three Scintrex CG-3M gravity meters deduced from continuous gravity recordings at Bondy from 1997 January 16 to 1997 February 20. (a) Computed long-term instrumental drift values using the linear and quadratic models. (b) Averaged admittance values between internal temperature and gravity computed from long-period recordings. (c) Admittance values between tilt responses and atmospheric pressure variations within the studied area.

Instrument serial number	9002136	9110193	9408267
(a) Instrumental drift			
Linear model			
Correlation coefficient	0.9999586	0.9999461	0.9999865
M_0 (mGal)	3.775	5.971	4.363
M_1 (mGal day^{-1})	0.243	0.521	0.349
Quadratic model			
Correlation coefficient	0.9999923	0.9999995	0.9999992
M_0 (mGal)	3.549	5.364	4.164
M_1 (mGal day^{-1})	0.258	0.561	0.362
M_2 (mGal day^{-2})	-0.000223	-0.000196	-0.000196
(b) Averaged long-term admittance between temperature and gravity (mGal mK^{-1})			
	0.344	0.161	0.185
(c) Admittance between tilt X and atmospheric pressure (arcsec hPa^{-1})			
	0.0957	0.1392	0.1314
Admittance between tilt Y and atmospheric pressure (arcsec hPa^{-1})			
	0.0954	0.1204	0.1913

signals. As a matter of fact, Goodkind (1986) showed that the influence of the atmospheric pressure was less than $0.1 \mu\text{Gal}$ for two meters 10 km apart. This result was confirmed by Merriam (1992), who argued that 90 per cent of the gravimetric effects originating from the atmosphere are constant over a 50 km radius area. However, in uneven regions where atmospheric effects may occur more frequently, a smaller radius should be considered. The various residual contributions due to the Earth tide or to atmospheric effects can potentially be eliminated by taking a difference between signals recorded by two gravimeters a few kilometres apart.

The superconducting gravimeters used by Goodkind (1986) had a better resolution than field gravimeters or microgravimeters. This is due to a quasi-null instrumental drift and to a very low noise in the measurements obtained on cryogenic gravimeters, which can detect very-small-amplitude time variations (sub- μGal level) (Hinderer, Crossley & Xu 1994). However, for some variations of geodynamic origin, such as those related to volcanic activity, the expected amplitudes do not necessarily require the use of cryogenic gravimeters. Besides, these gravimeters are poorly adapted to difficult field conditions such as those encountered on volcanoes.

In order to assess the Scintrex CG-3/3M gravimeters' capacities under continuous recording conditions, time-series

acquired on several instruments set in similar recording conditions at the same site have been compared. Four Scintrex CG-3M gravimeters (numbered 9002136, 9110193, 9408267, and 9601323) with a sensitivity of $1 \mu\text{Gal}$, bought by ORSTOM and the Institut de Physique du Globe, Paris, between 1990 and 1996, were used in this experiment. The main objectives of this study were

- (1) to establish the relative stability and the accuracy of the meters;
- (2) to estimate the contribution of the instrumental effects for this type of instrument;
- (3) to quantify the amplitude of the variations that could be detected by a gravimetric differential method.

3.2 Experimental set-up

For several weeks in 1996 and 1997, three instruments set for continuous recording were installed side by side in a vault at the ORSTOM research centre in Bondy ($48^{\circ}54'55''\text{N}$, $2^{\circ}29'09''\text{E}$). The fourth meter, not available for a long period of continuous recording at that time, was used for calibration purposes. Recordings were made at a sampling rate of one point per 2 min (cycle time 120 s, read time 90 s, calibration

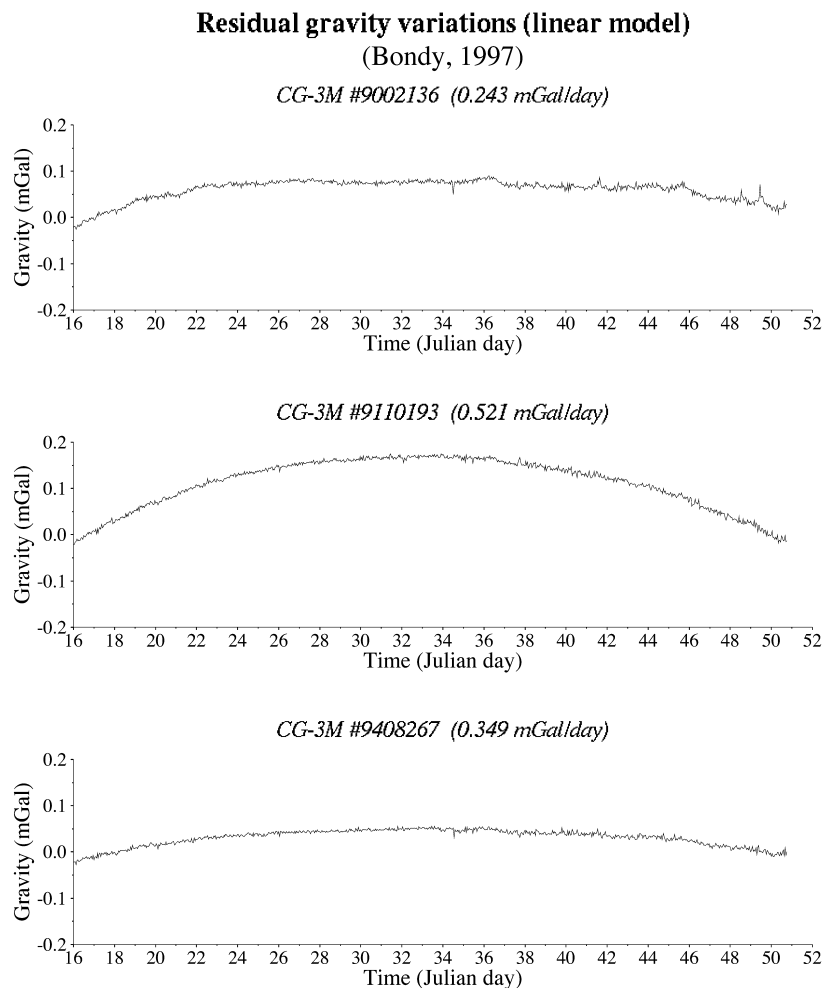

Figure 4. Residual gravity signals obtained after removal of a linear drift and of an accurate Earth tide model. It can be seen that the linear model does not fit the instrumental drift over this period of time (see text and numerical values in Table 1).

frequency 1/12 sample). First, tuning of the sensitivity and temperature, and tilt corrections were performed on all instruments, according to the recommendations made by Scintrex (1995). This tuning ensures that the measurements are properly corrected. In order to quantify the actual instrumental drift, the drift correction parameters and the offset were initialized to zero. To ease the reading of the time-series recording over a long period of time (greater than a month) and to facilitate their comparison with other recordings made simultaneously (meteorological), the gravity signals were later under-sampled at a sampling rate of one point per hour. To study the residual responses of the various gravimeters, contributions linked to the earth tide and the instrumental drift were first removed from the recordings.

3.3 Earth tide correction

The Earth tide correction computed by the Scintrex software is based on an algorithm developed by Longman (1959). The correction is applied in real time to the measurements. The model used in this software was not accurate enough for microgravity studies. Thus, a new correction was computed using the theoretical model produced by the Belgium Royal

Observatory (Ducarme, personal communication). For each wave group, the amplitude and phase coefficients of this model were determined on the basis of the analysis of the tide observed at the Bureau International des Poids et Mesures in Sèvres, France. Because of the closeness of our measurement site (less than 20 km away) to that reference, the same coefficients were applied for the computation of the tide correction. Fig. 2 shows the deviation between the correction so determined and the one computed by the Scintrex software for the time period covered by the gravimetric recordings. Taking into account all effects related to the tide in this accurate model leads to an improvement of up to 10 μGal with respect to the standard model applied in the software. This precise Earth tide correction was computed by means of the interactive CG3TOOL software especially designed for Scintrex CG-3/3M data processing (Gabalda & Bonvalot 1997).

3.4 Instrumental drift

Raw recordings for the time period between 1997 January 16 and 1997 February 20 are presented in Fig. 3. No tide correction has been applied to these data. The instrumental drifts observed during this time period on the various meters are all

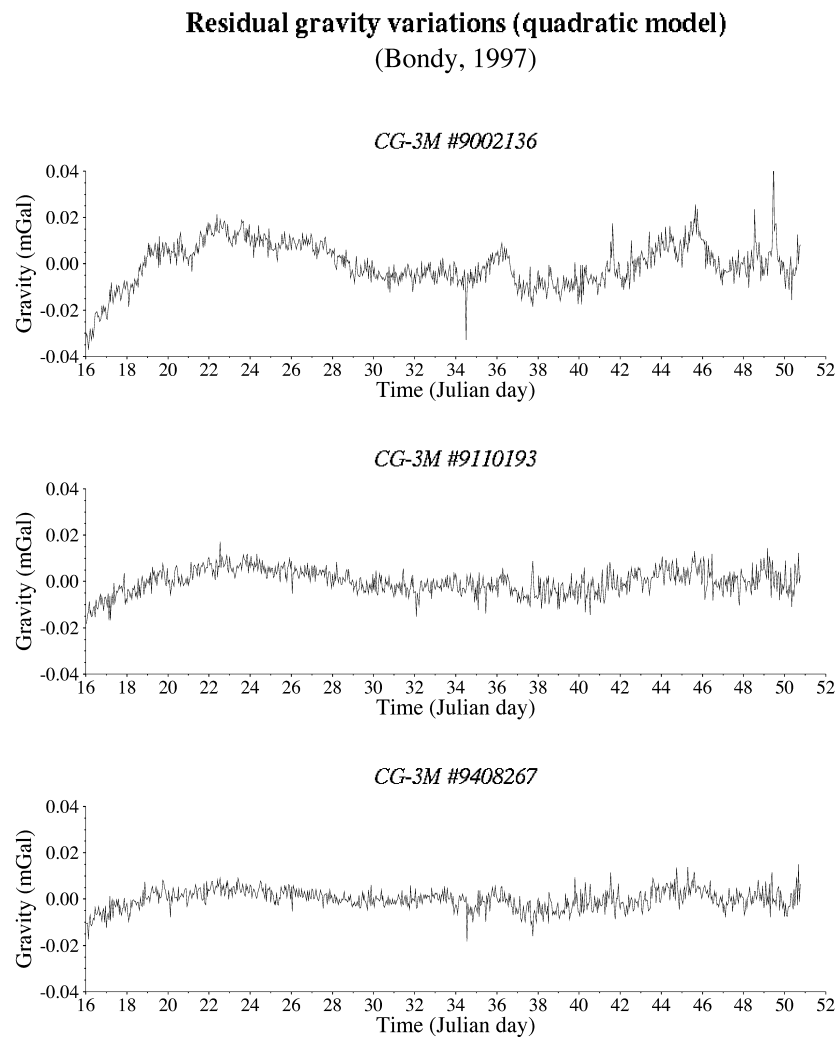

Figure 5. Residual gravity signals obtained after removal of a quadratic drift and of an accurate Earth tide model. It can be seen that the quadratic model correctly fits the instrumental drift for all instruments (see text and numerical values in Table 1).

positive, but slightly different from each other. After the lunar–solar tide effect had been corrected on the basis of the previous computation, the instrumental drift of the various meters was quantified using two drift models, the first linear and the second quadratic.

In the first computation, a drift trend of the form $y = M_0 + M_1 t$ was removed. The long-term linear drift values defined in this way can reach several tenths of a mGal per day. They vary slightly from one instrument to another, as shown in Table 1. The residual gravity variations (Fig. 4) vary between 0.05 and 0.2 mGal depending on the instrument. They clearly demonstrate that the linear model does not fit the long-term instrumental drift. However, the linear model is more suitable to shorter time windows, up to 10 days. This result conforms to the manufacturer's specifications for these instruments.

Residual signals obtained by removing a quadratic drift of the form $y = M_0 + M_1 t + M_2 t^2$ from the recordings are shown in Fig. 5. The coefficients for this model are reported in Table 1. The shape and amplitude of the residual signals confirm that the quadratic model correctly fits the instrumental drift over time periods greater than several days. The residual variations are relatively consistent among the different instruments, even though they seem strongly amplified (by a factor of 2) for

meter 9002136. Nevertheless, the amplitude of these variations is large and oscillates between -0.025 and $+0.025$ mGal for devices 9110193 and 9408267 and between -0.050 and $+0.050$ mGal for device 9002136.

When compared to other field gravimeter instrumental drifts, that of the CG-3M gravimeters appears quite large. According to Hugill (1990) and Scintrex (1995), this long-term drift is high when the sensors are manufactured but should decrease to a value of 0.2 mGal day^{-1} after several years of usage. After correction of the measurement series for an average long-term drift, the residual drift should be lower than 0.02 mGal day^{-1} . The relationship between the long-term drift and the instrument age has not been verified in this study, where the strongest drift was observed for an instrument purchased in 1991 (Fig. 3). However, it can be assumed that a change in the instrumental drift occurred in 1995 after this instrument had been serviced by the manufacturer. The long-term instrumental drift characteristics of the Scintrex CG-3M gravimeters are discussed later.

3.5 Instrumental noise and microseismicity

As shown in Fig. 5, a high-frequency noise affects all residual gravity signals. Its amplitude is estimated to be about 0.01 mGal for the first set of recordings (days 16–34) and about 0.015 mGal

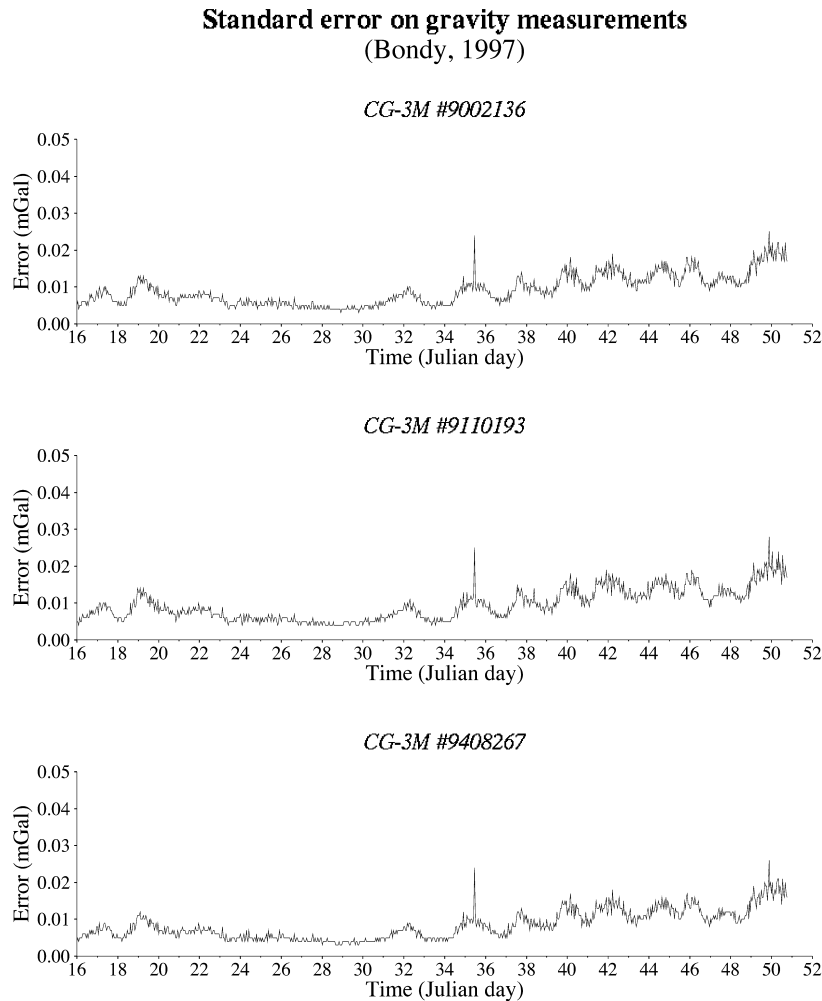

Figure 6. Standard errors obtained for the three instruments side by side (Bondy, from 01/16/97 to 02/20/97). The similarity of the various responses indicates that all instruments have the same sensitivity to external noise.

for the second set of recordings (days 34–52). Fig. 6 shows the standard errors computed for the corresponding measurement series. For each instrument, these errors lie within the range 0.005–0.015 mGal, and are slightly higher for the second set of recordings. These errors are derived from the standard-deviation values of each measurement computed by the Scintrex software. Each measurement is defined by an arithmetic mean over a series of N values and the corresponding standard deviation SD . Individual values with an error more than four times larger than the standard deviation are rejected from the mean computation (an option available in the Scintrex software), leading to an actual number of values included in the computation, DUR , that is smaller than N (Scintrex 1995). On the assumption that the noise is normally distributed, the error in the measurements series is estimated as follows:

$$Err = \frac{SD}{\sqrt{DUR}}. \quad (1)$$

This error includes both the instrumental accuracy of the acquisition system and the surrounding microseismic noise acting on the vertical spring at various frequencies. However, a homogeneity of the measurement errors for all gravimeters is observed over time. This response demonstrates the identical sensitivity of the different instruments to the same external phenomena. Therefore, these instruments can be considered to be an accurate tool to measure the microseismic activity level at a given site.

4 INSTRUMENT RESPONSES

Residual variations obtained after Earth tide and instrumental-drift corrections may be linked to geophysical, atmospheric or

instrumental factors. In order to assess the contribution of instrumental factors, a possible correlation between the gravity residuals and other parameters measured over the same time period was investigated. We considered in this comparison the parameters recorded by the instrument such as the internal temperature and the sensor inclination. In addition, we used local meteorological data recorded close to the studied area.

Fig. 7 displays atmospheric pressure and temperature variations observed over the same period of time. These data, acquired at a sample rate of one point per hour, come from a station of the French meteorological array (Roissy station), located less than 15 km away from the measurement site. We first examine the thermal and inclinometric instrument responses, since the Scintrex software corrects each gravity measurement in real time for the internal temperature and the sensor tilt.

4.1 Thermal responses

Fig. 8 presents the internal temperature variations recorded for the various gravimeters after removal of a linear trend. The parameter varies in a consistent manner for all the meters, but with slightly different drift values (0.005 – 0.012 mK day⁻¹). Short-wavelength variations, identified on gravimeter 9002136, can also be observed on the other meters, but strongly attenuated. A comparison with the meteorological recordings (Fig. 7) shows that these thermal variations are not correlated with the local variations of the temperature, but that they are perfectly correlated with atmospheric-pressure variations. This correlation is the result of the direct effect of the external pressure on the temperature and reveals either a poor insulation of the gravimeter (the temperature sensor is located close to the gravity sensor in the thermostatically controlled

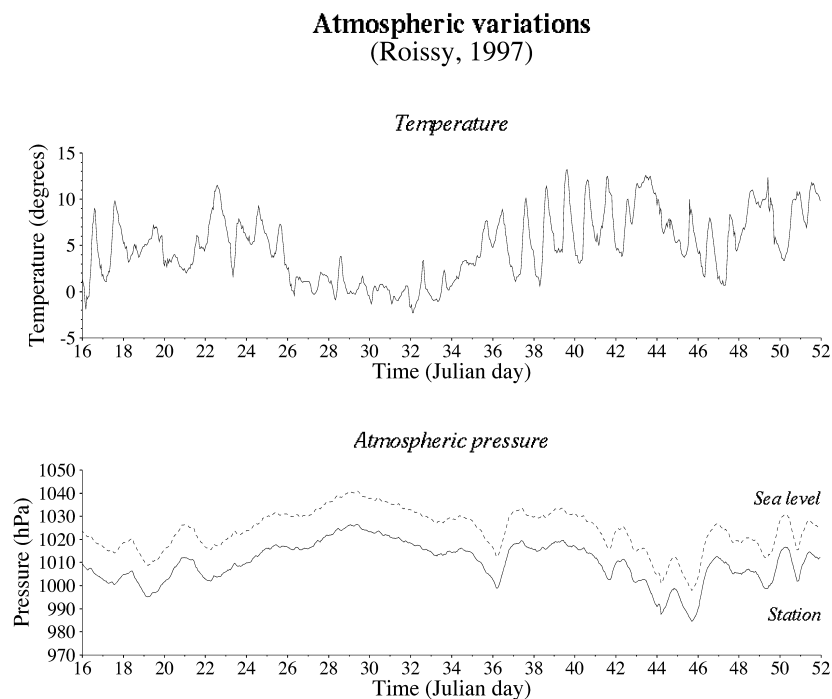

Figure 7. Variations of the temperature and atmospheric pressure observed in the area of Bondy during the period of gravimetry recordings (at the site of Météo France, Roissy, from 01/16/97 to 02/20/97). The pressure recorded at the station elevation and the pressure reduced to sea level are displayed as solid and dashed lines, respectively.

Internal temperature variations (Bondy, 1997)

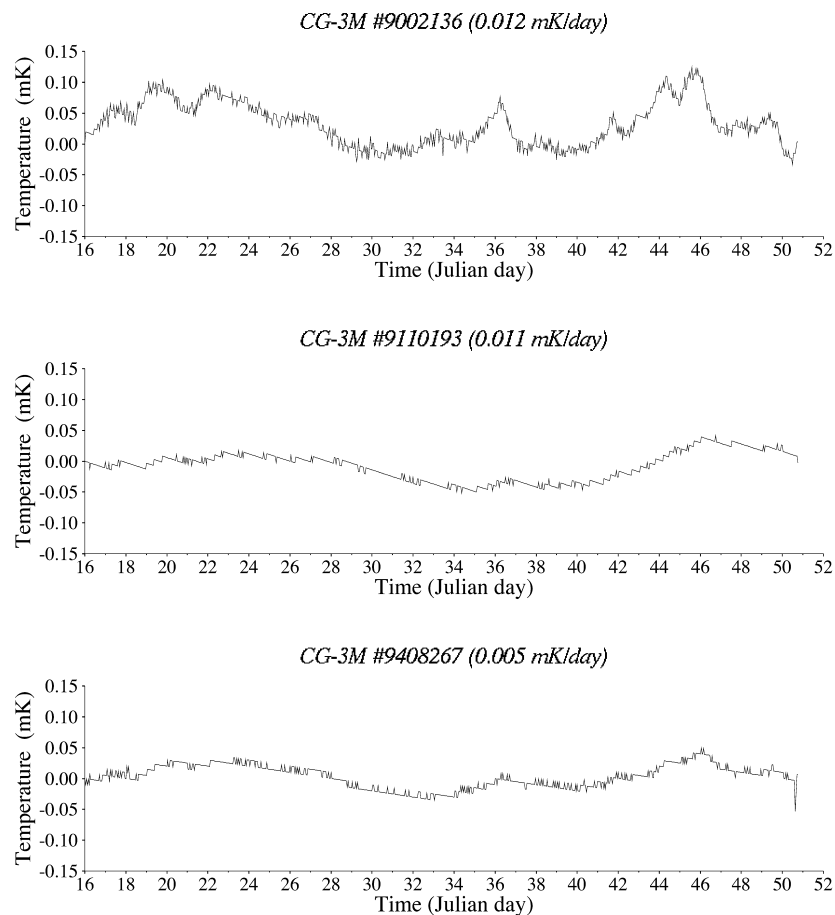

Figure 8. Variations of the internal temperature of the gravimeters after removal of a linear drift. A comparison with simultaneous meteorological recordings shown in Fig. 7 demonstrates a strong correlation between the atmospheric pressure and internal temperature for meter 9002136.

chamber) or an important sensitivity to pressure variation of some of the acquisition system elements (electronic components). Such relationship has already been observed during previous laboratory studies (Jousset 1996).

In order to suppress this effect, the transfer function linking the local atmospheric pressure to the instrument internal temperature has been computed for device 9002136. This function was determined by applying a linear regression between both parameters (Fig. 9a). The result of this regression shows that a factor of $-0.0033 \text{ mK hPa}^{-1}$ could be used to remove the correlation between the two signals. After applying this correction, the thermal signal becomes comparable to those obtained on the other devices (Fig. 8). It should be noted that this effect of atmospheric pressure can hardly be detected in the thermal or gravimetric recordings from the other instruments. The higher sensitivity to pressure of meter 9002136 may be related either to its older age (first generation of CG-3M, with a less robust acquisition system than the later instruments) or to the fact that the device is thermostatically controlled at 55°C (high-temperature option, CG-3MH) while the others are controlled at 45°C (standard option).

The internal temperature variations over a short period of time seem to be well correlated with the residual gravity

variations already identified for this instrument (Fig. 5). This can be explained by the fact that the internal temperature is used to correct in real time the measurement series of the thermal variations made in the sensor enclosure (Fig. 1). The correction factor (*TEMPCO*), determined experimentally by the manufacturer for each instrument, ranges from -0.1 to $-0.15 \text{ mGal mK}^{-1}$. It is applied in a temperature window from -2.0 to $+2.0 \text{ mK}$. Hence, perturbations of the internal temperature of the sensor can induce large gravimetric variations. In the case of meter 9002136, the temperature correction was recomputed using the instrument's own correction factor *TEMPCO* ($-0.1383 \text{ mGal mK}^{-1}$), applied to the corrected thermal signal obtained by using the previously computed coefficient ($-0.0033 \text{ mK hPa}^{-1}$). Fig. 9(c) shows that the resulting residual signal becomes comparable to those of the other devices (Fig. 5).

4.2 Inclinometric responses

The inclinometric responses of the gravimeters are displayed in Fig. 10, for two perpendicular axes *X* and *Y*. These responses are homogeneous: the long-term drifts, as well as the daily variations, are identical on all devices. No drift is noticeable

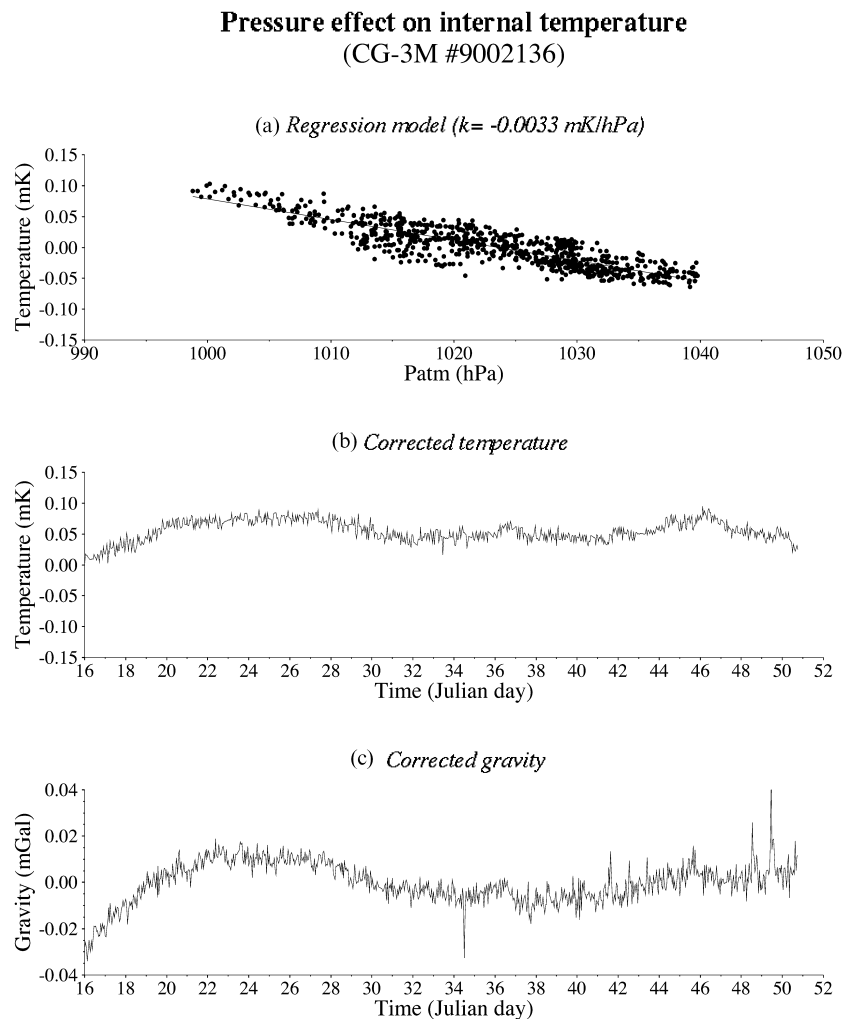

Figure 9. Influence of the atmospheric pressure on the internal temperature of the gravimeter 9002136 (see text and Figs 7 and 8). (a) Regression model between the two parameters. The corrected temperature (b) and gravity (c) signals should be compared to the raw data in Figs 8 and 5, respectively.

along the Y axis for the whole recording period, while a weak drift of about 20 arc seconds on the X axis is seen for the same time period. These observations indicate, on one hand, the relative stability of the measurement site, and on the other hand, the excellent stability of the inclinometers used in the gravimeters. At short periods, there is a weak correlation between the tilt responses and the atmospheric-pressure recording (Fig. 7). This correlation, occurring without any phase lag, might be related to the pressure effect of the air column on the external enclosure of the gravity meters. The coefficients derived from a linear regression analysis of this correlation are shown in Table 1 and Fig. 11. The admittance values, ranging from 0.09 to 0.2 arcsec hPa⁻¹, lead to a slight correction of the inclination signals, of less than 5 arcsec. According to the relation between gravity and tilt variations, these corrections are lower than the 1 μ Gal level. In view of the very low amplitude of this effect of the atmospheric pressure on the tilt and gravity recordings, it has been neglected in the following computations.

On Scintrex CG-3/3M devices, the tilt parameter is usually used to apply real-time corrections to the gravity measurements. Any atmospheric-pressure effect on the tilt meters will

then produce a corresponding gravity correction. This correction is applied to gravity readings for tilt variations within a ± 200 arcsec range. The gravity value corrected in this way, $R(\theta_x, \theta_y)$, can be expressed as (Scintrex 1995)

$$R(\theta_x, \theta_y) = RU(0, 0) - gt(\cos \theta_x \cos \theta_y - \cos X \cos Y), \quad (2)$$

where $RU(0, 0)$ is the uncorrected gravity reading for $\theta_x = \theta_y = 0$, gt is the mean gravity value at sea level, θ_x and θ_y are the tilt values of the gravity sensor in the x and y perpendicular directions, and X and Y are the corresponding values displayed by the software.

According to Scintrex (1995), the perfect tilt adjustment condition is the coincidence of instrument zero tilts, as defined by the digital read-out of the bubble level and the tilts referred to the horizontal as defined by the maximum sensor output. For correct operation, the tilt adjustment should be periodically checked following the manufacturer's recommendations. The tilt zero sensor position is obtained by hardware tuning using footscrews. The tilt calibration factors in the x and y directions are then experimentally defined by comparing the gravity readings obtained for extreme tilt values of about 150 arcsec. The correction factor for each tilt correction constant is

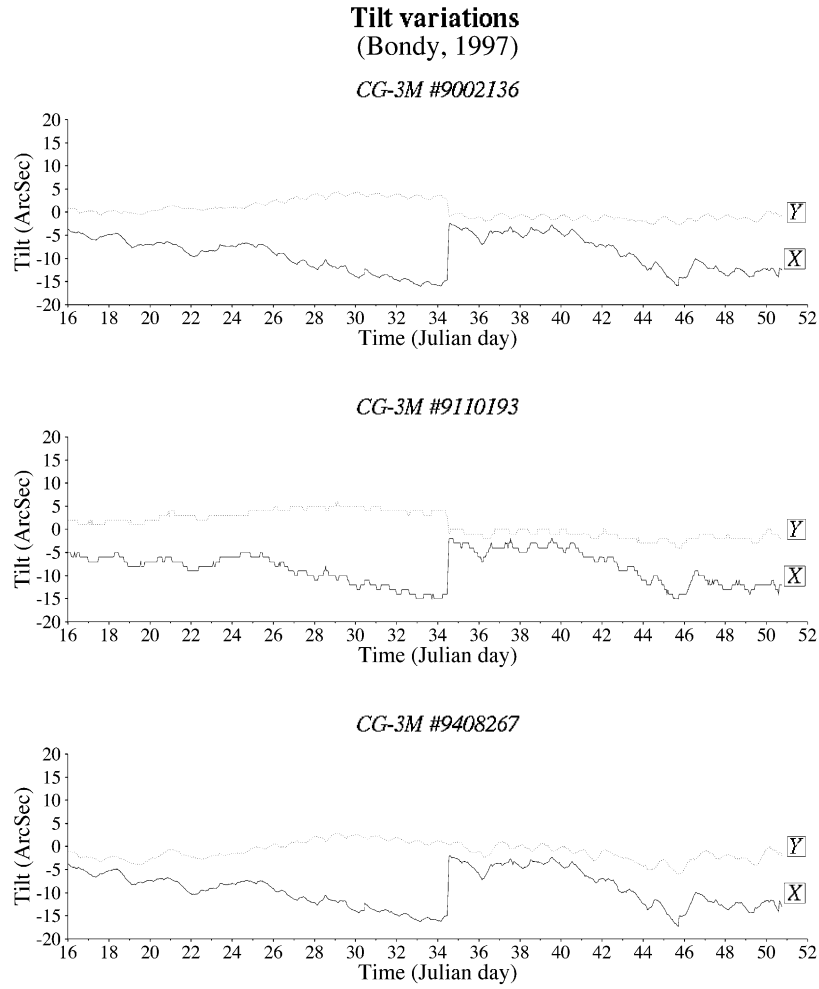

Figure 10. Variations of the tilts along the *X* and *Y* axes of the three side-by-side gravimeters (Bondy, from 01/16/97 to 02/20/97). The jump at day 34 corresponds to a manual resetting of the tilts. Instruments 9002136 and 9408267 were equipped with high-resolution tiltmeters (0.1 arcsec). A correlation with atmospheric-pressure variations can be observed at short wavelengths (see Fig. 7).

expressed as

$$K = \sqrt{1 + 8.7 \times 10^4 \frac{(R_0 - R_1)}{X_1^2}}, \quad (3)$$

where R_0 and R_1 are the respective gravity readings in mGal taken at tilt values $X_0 = 0$ and $X_1 = \pm 150$ arcsec.

The absence of correlation between any of the gravimetric and inclinometric recordings (Figs 5, 9 and 10) ensures, on one hand, that the tilt corrections have been correctly computed in the real-time processing and, on the other hand, that the tilt zero adjustment and tilt sensitivity have remained stable during the whole period of data acquisition. This latter point can be clearly checked on day 34, where the resetting of all tilt sensors to zero is not associated with a jump in the corresponding gravity recordings (Figs 5 and 10).

Fig. 10 also shows a higher resolution of tilt recordings for meters 9002136 and 9408267. The standard 1 arcsec resolution has been improved to 0.1 arcsec by using new software to check the actual accuracy of the tilt sensors. On the basis of these responses, it can be verified that the instrumental noise is lower than 1 arcsec. One of the reasons for the apparent accuracy of the tilt sensors comes from the fact that the bubble levels are co-located with the gravity sensor, in the thermo-

statically controlled enclosure, and are therefore isolated from any temperature variation. Results from additional tests performed on the tilt resolution are given later in this paper.

4.3 Residual gravity responses

The results presented above show that the influence of the atmospheric pressure on the internal temperature and tilt parameters could induce non-negligible gravimetric variations at short periods during real-time data processing. Nonetheless, these instrumental effects can be removed from the gravimetric recordings later, if local meteorological recordings made simultaneously are available.

Long-term temperature correction

Over long periods, a correlation appears between the residual gravity signals and the internal temperature. It may indicate the persistence of an instrumental effect (Figs 5, 8 and 9). In order to reduce this effect, the transfer functions between these two parameters were computed in the frequency domain. The resulting admittance function is given as follows, for a given

Pressure effect on tilt variations

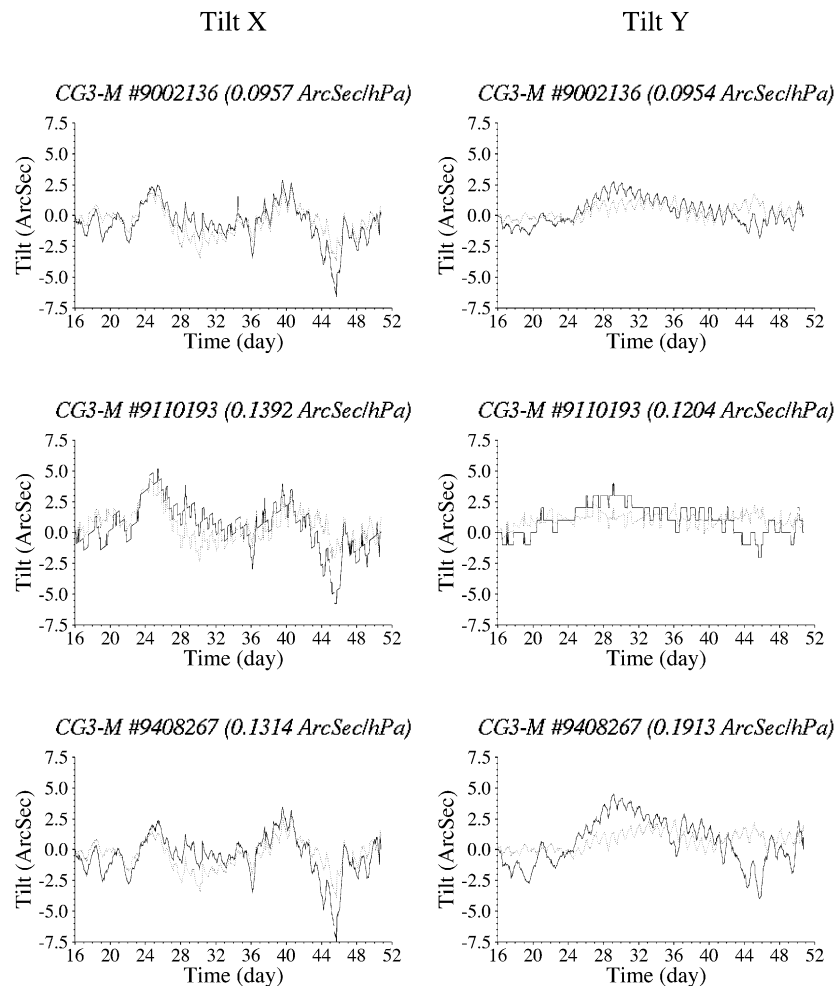

Figure 11. Influence of the atmospheric pressure on the gravimeter tilt-meter responses (Bondy, from 01/16/97 to 02/20/97). Thick lines show uncorrected tilts and thin lines show tilts corrected using the coefficient determined for each meter by a linear regression between the two parameters (see text and Table 1).

frequency f :

$$Z(f) = \frac{G(f) \times T^*(f)}{T(f) \times T^*(f)}, \quad (4)$$

where $G(f)$ and $T(f)$ are the energy spectra of the gravimetric and thermal signals, respectively, and $T^*(f)$ is the complex conjugate of $T(f)$.

The energy spectra were computed by a Fourier transform after removal of the linear trend. High frequencies were filtered by applying a smoothing polynomial filter. The parameters applied for this filtering were determined by computing the maximum of the correlation corresponding to the largest values of coherence between a pair of signals. For each meter, the coherence, as well as the corresponding admittance and phase functions, is shown in Fig. 12. Coherence values greater than 0.5 are observed for the lower frequencies (below 4 or 5 cycles day⁻¹), before a sharp drop in the coherence. Within this same low-frequency band, constant values of the admittance and null values of the phase are obtained for each meter, indicating a very good correlation between the gravity and temperature signals.

For each instrument, a mean value of the admittance was computed by averaging the values obtained for periods corresponding to coherence values greater than 0.5 (periods greater than 5 or 6 days). The results are shown in Table 1. These values reflect the long-term correlation between the thermal variations and the gravimetric variations. This correlation cannot be taken into account in the correction factor $TEMPCO$ which is determined experimentally over very short periods of time (a few hours). Gravity recordings corrected for long-period temperature variations using admittance values determined in this study are reported in Fig. 13. The effect of the removal of this long wavelength is clearly seen in the signals and significantly improves the gravity recordings. This observation proves that a more accurate signal can be obtained by post-processing the data while looking for the correlation with the thermal signals recorded simultaneously.

Correction for the direct effect of the atmospheric pressure

So far, the gravimetric signals have been corrected for the indirect effects of the atmospheric pressure (through the temperature

Temperature / Gravity spectral correlation

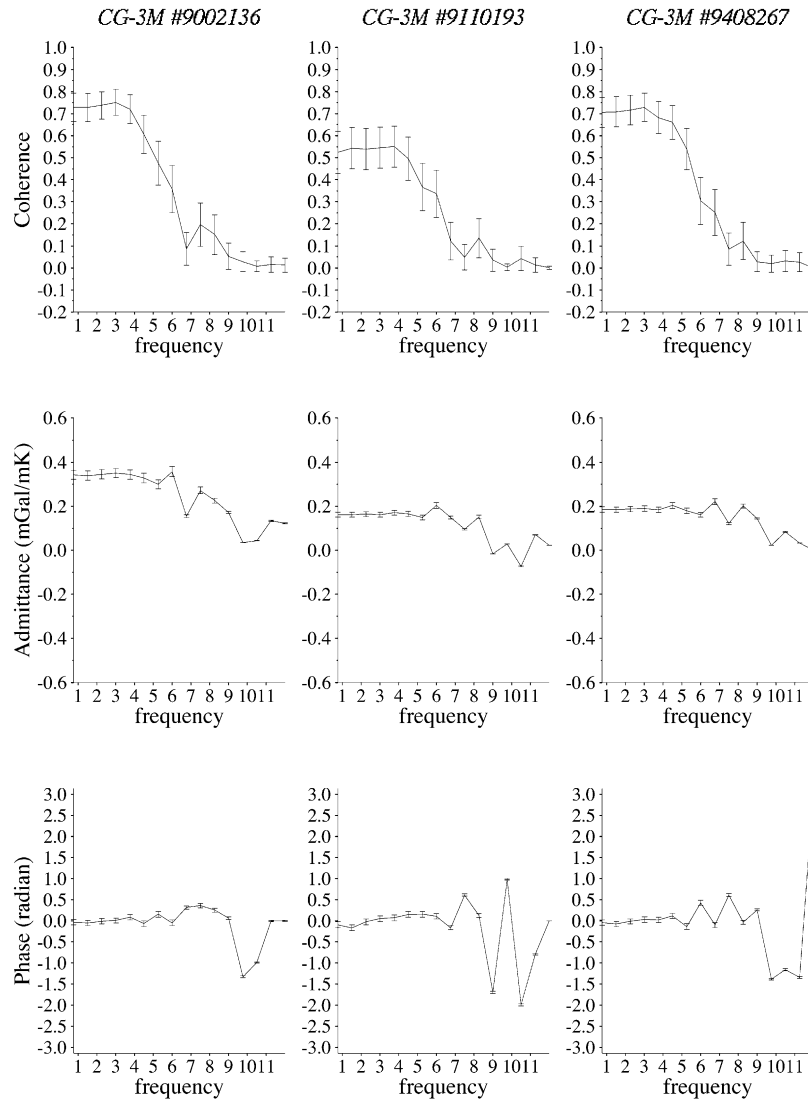

Figure 12. Transfer functions (coherence, admittance and phase) between the gravity and the thermal signals computed in the frequency domain for each Scintrex CG-3M gravimeter between 01/16/97 and 02/20/97. A pre-processing was applied to the signals in order to remove the linear trend and to filter high frequencies (see text). This figure shows that the coherence is greater than 0.5 for all meters for time periods greater than 5–6 days (frequency lower than 5). The admittance is flat in this domain and the phase is close to zero. Therefore, an average coefficient (in mGal mK^{-1}) can be obtained and later used in post-processing (see Table 1). This coefficient differs from the short term one given by the manufacturer. Frequency unit: cycles day^{-1} ; period (day) = k/f , with $k = 26.25$.

or the tilt), but the direct influence of the atmospheric pressure has not been taken into account. The influence of the atmospheric pressure on the gravity field, as pointed out by several authors (Warburton & Goodkind 1977; Merriam 1992), is induced by the weight of the air column and can vary between 0.2 and $0.4 \mu\text{Gal hPa}^{-1}$. The related correction can be computed using a standard model or a value defined from simultaneous recordings of the pressure and of the gravity field. A standard value of $0.356 \mu\text{Gal hPa}^{-1}$ (Merriam 1992) was applied to correct the gravity recordings for the atmospheric-pressure variations observed near the surveyed area (Fig. 14). Here, the maximal amplitude of the direct effect of the atmospheric pressure is less than $15 \mu\text{Gal}$ over the period

of time considered. Taking this influence into account improves the quality of the observed gravity signals, particularly at the short wavelengths.

4.4 Differential signal computation

The residual gravity signals obtained after applying the various corrections show a noise of the order of 0.01 mGal as well as comparable amplitude variations for the short and long wavelengths. These variations can be related to effects not taken into account or not properly corrected during data processing (insufficiently accurate Earth tide or atmospheric-pressure corrections, etc.). Given that these effects might be considered

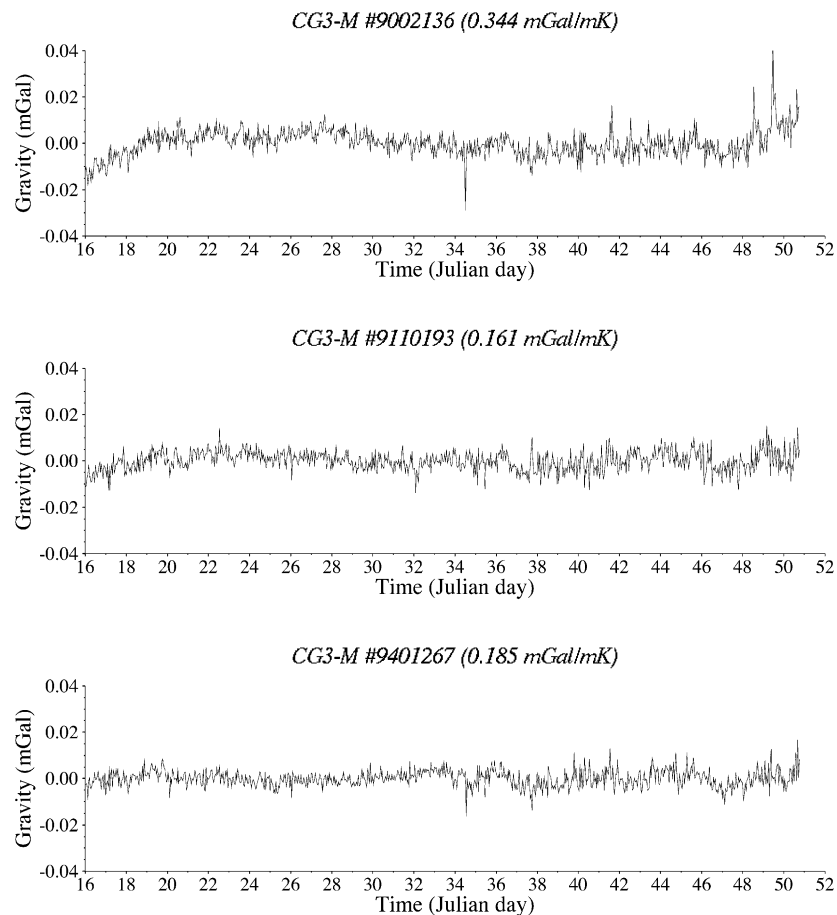

Figure 13. Gravity responses corrected for the instrumental thermal effects using the long-term coefficient (see Fig. 12 and Table 1). Comparison with Fig. 5 shows that the residual is flatter after the removal of this long term thermal effect.

as constant over an area of a few square kilometres, they can be easily eliminated by applying a difference between residual gravity signals recorded on several instruments not too far apart.

In order to analyse these differential signals, the instruments should be precisely calibrated. For this purpose, several methods can be used, for instance the measurement of a calibration line or the computation of the admittance between theoretical and observed tide signals. The latter method does not require the movement of the instruments and seems to be particularly well adapted to the analysis of signals recorded on permanent gravimeter networks. An example is given by Jousset *et al.* (in press) for the processing of the time-series recorded on the Merapi volcano. Here we calibrated the various instruments on a calibration line covering the measurement range of the continuous recordings. Calibration deviations observed between different instruments were smaller than $5 \mu\text{Gal}$. The details and results of these computations are discussed later in this paper.

Using residual signals properly corrected for the instrumental effects and for the calibration discrepancies determined as described above, differences in the recorded parameters (gravity field, standard error, temperature, tilts) between instruments were computed over the same time period. Figs 15(a) and (b) show the differences observed for gravimeters 9002136 and 9110193, respectively, using instrument 9408267 as a reference.

Differences lower than $\pm 15 \mu\text{Gal}$ are observed in the gravity differential measurements over more than a month of recording. Better results are obtained for the difference between gravimeters 9110193 and 9408267 (Fig. 15b) because their instrument responses are more homogeneous. If the high-frequency noise in the gravimetric signals is filtered first (Fig. 14), the differences observed with respect to the reference gravimeter are of the order of ± 5 and $\pm 10 \mu\text{Gal}$ for the gravimeters 9110193 (Fig. 15b) and 9002136 (Fig. 15a), respectively. A similar study performed on shorter time-series allowed to verify that the deviations could be reduced to ± 2 to $\pm 3 \mu\text{Gal}$ over a few days. As previously noticed, the standard errors responses (deviation $< \pm 3 \mu\text{Gal}$) and the tilt response (deviation $< \pm 3$ arcsec) are remarkably homogeneous. The observed temperature differences remain below 0.05 mK .

Therefore, we conclude that Scintrex CG-3M gravimeters in a differential mode can allow the detection of gravity field time variations with an accuracy up to $5\text{--}15 \mu\text{Gal}$ over time periods of several weeks. However, this accuracy, obtained under particularly favourable conditions, is slightly better than the actual resolution classically obtained in field conditions (Rymer 1989; Torge 1989). This study was performed with the standard seismic-noise filter. We might expect more accurate results using the filter proposed in 1997 by Scintrex for the new CG-3/3M software. According to the technical specifications,

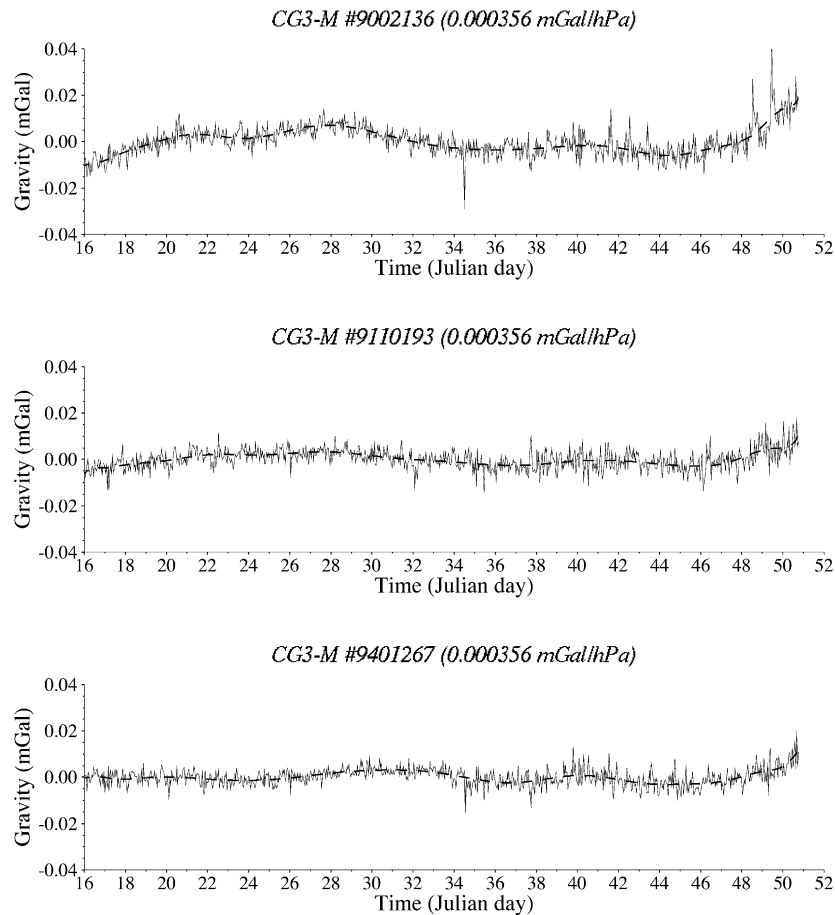

Figure 14. Gravity responses corrected for the atmospheric pressure using a standard value of $0.356 \mu\text{Gal hPa}^{-1}$. The dashed lines correspond to the signals filtered for high-frequency variations by applying a polynomial smoothing.

this new filter could decrease the noise of the gravity recording by a factor of at least 5 times during periods of high seismicity.

5 GRAVIMETER CALIBRATION

5.1 Set-up

The calibration factors of the gravimeters used in this study were checked in the same measurement range using the calibration line of the Bureau International des Poids et Mesures (BIPM), Sèvres, France. This line was established in 1994 during the fourth intercomparison of absolute and relative gravimeters (Becker *et al.* 1995) using fourteen LaCoste & Romberg relative gravimeters (D and G models). It includes six stations and covers a measurement range of about 8 mGal. Measurements were made on 1997 February 20 taking as a reference one of the BIPM absolute measurement stations. All measurement sites were used at least twice with four Scintrex CG-3M gravimeters. The measurements were corrected for the Earth tide, taking into account precise amplitude and phase coefficients computed earlier for this site (Ducarme, personal communication).

5.2 Calibration results

Calibration factors were computed by applying a linear regression between the observed values obtained at each station

using Scintrex devices and the reference values (mean values obtained in 1994 with fourteen LaCoste & Romberg gravimeters). Fig. 16(a) shows the residuals between these two sets of values as observed at each station, as well as the calibration factors computed for the different meters. The largest difference between the values obtained on Scintrex instruments and the reference is about 0.015 mGal. It can be noticed that the results obtained with the different meters are very consistent: the calibration factors are lower than 1 and the residues observed at each station have the same sign. This observation, already made in the past (Jousset *et al.* 1995), could be related to a slightly different sensitivity of the Scintrex instruments from that of the LaCoste & Romberg gravimeters (magnetic effect). In order to verify the homogeneity of the Scintrex CG-3M instruments, relative calibration coefficients were also computed using one of the instruments (9408297) as a reference. The residual deviations observed between the recalibrated devices and a reference defined as a mean over the four instruments are shown in Fig. 16(b). In this study, for the three instruments used in the computation of the differential signals, the calibration deviations remained below or equal to $5 \mu\text{Gal}$.

6 DISCUSSION

The analysis of continuous data recorded on three Scintrex CG-3M instruments allows us

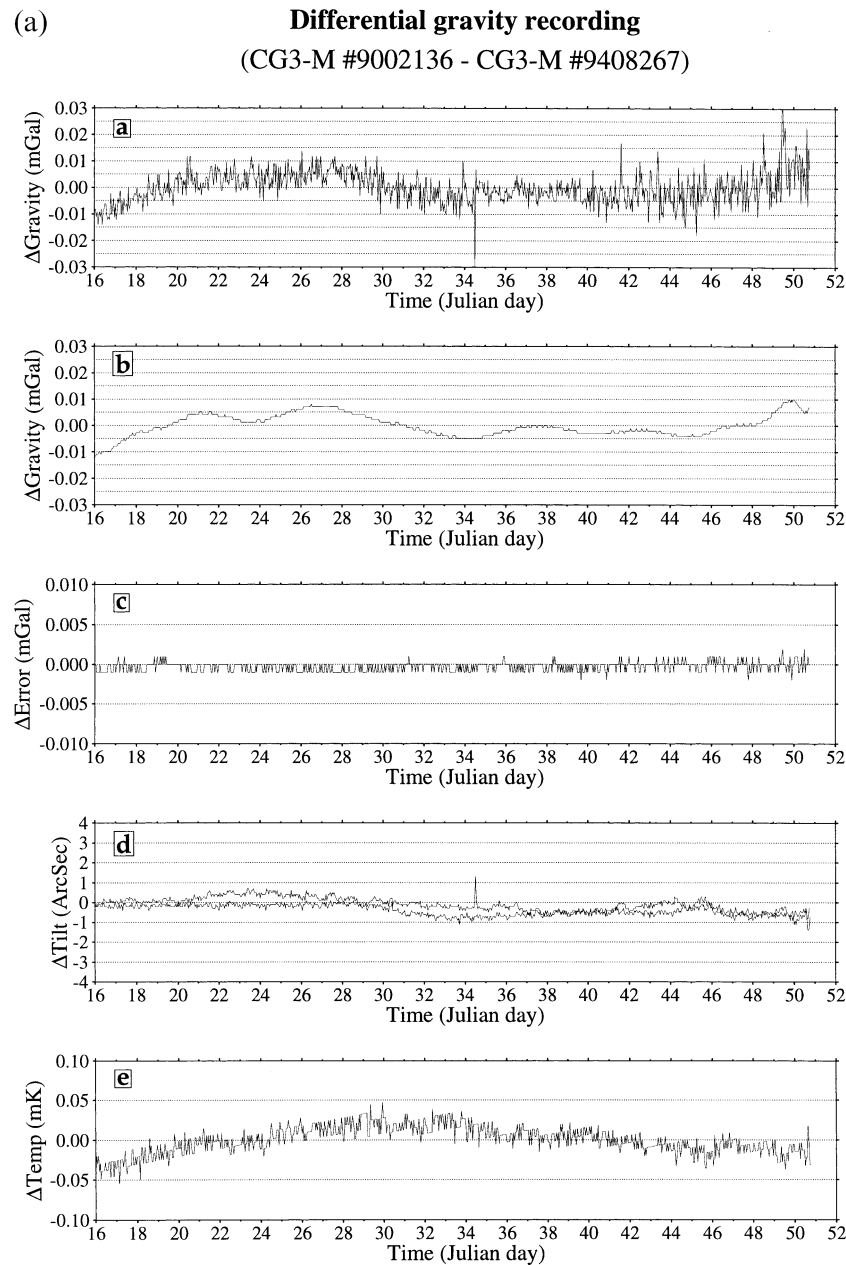

Figure 15. Differential instrumental responses for the gravimeters. (a) Responses corresponding to the differences between the signals acquired on gravimeters 9002136 and 9408297 at Bondy between 01/16/97 and 02/20/97: curve a, difference between the gravity signals; curve b, difference between the filtered gravity signals (see Fig. 14); curve c, difference between the measurement errors; curve d, difference between the tilt signals; curve e, difference between the thermal signals. (b) Responses corresponding to the difference between signals acquired on gravimeters 9110193 and 9408267 at Bondy between 01/16/97 and 02/20/97; curves a–e as in part (a).

- (1) to define some of the instrument characteristics;
- (2) to evaluate the accuracy of the measurements when the instruments are used in a differential mode.

Several aspects specific to the instrument characteristics and accuracy can be discussed qualitatively and quantitatively.

6.1 Instrumental artefacts

It has been noted that some instruments could show a strong sensitivity to atmospheric-pressure variations. In addition to

this well-known direct influence, these variations can affect significantly the gravity signal through the automatic corrections of the temperature and the tilt. Nonetheless, as we have shown in this study, this dependence can be easily controlled and corrected during the post-processing by looking for a possible correlation with simultaneous weather recordings. In the same way, a long-term correlation exists between the gravimetric signal and the internal temperature of the device. The thermal correction applied in real time by the Scintrex CG-3/3M gravimeter cannot take into account such effects revealed over longer periods of time; only a post-processing of the data series allows one to correct these effects.

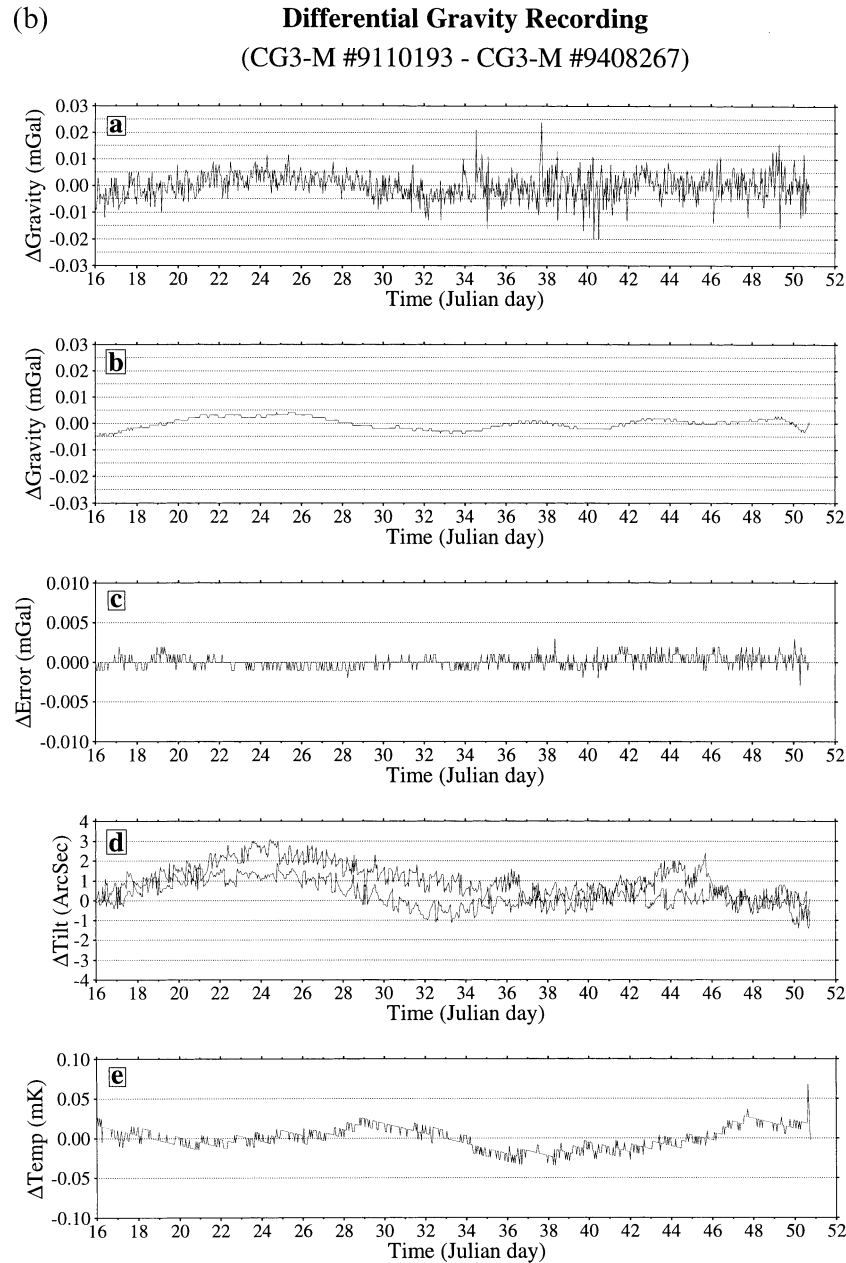

Figure 15. (Continued.)

It is necessary to determine the instrumental effects for each instrument prior to any study based on continuous microgravity recordings that is intended to investigate temporal gravity variations with a geodynamic origin. The importance of simultaneously acquiring the largest possible number of parameters affecting the quality of the instrument responses (atmospheric pressure, temperature, tilt, etc.) has already been pointed out by Goodkind (1986). This point demonstrates the added value of these parameters (temperature and tilt). Given the importance of the atmospheric pressure in this type of study, we recommend that sensors recording the surrounding pressure be integrated in the next generation of microgravimeters. The recording of this parameter could then be used to correct gravity series in real time or at a later stage in the processing.

6.2 Accuracy of the instrumental responses

The accuracy of the measurements made with the Scintrex CG-3M gravimeters has been estimated with four instruments in two utilization modes, as follows.

(1) In-field discrete measurements: during the calibration using the reference stations of the BIPM, an accuracy of about $5 \mu\text{Gal}$ was obtained over a measurement range of 8 mGal. This result has been confirmed by other calibration surveys carried out over wider ranges of measurement in the frame of microgravity studies applied to volcanology (Budetta & Carbone 1997).

(2) In continuous recording mode: this study shows that several instruments can reveal time variations of small amplitude

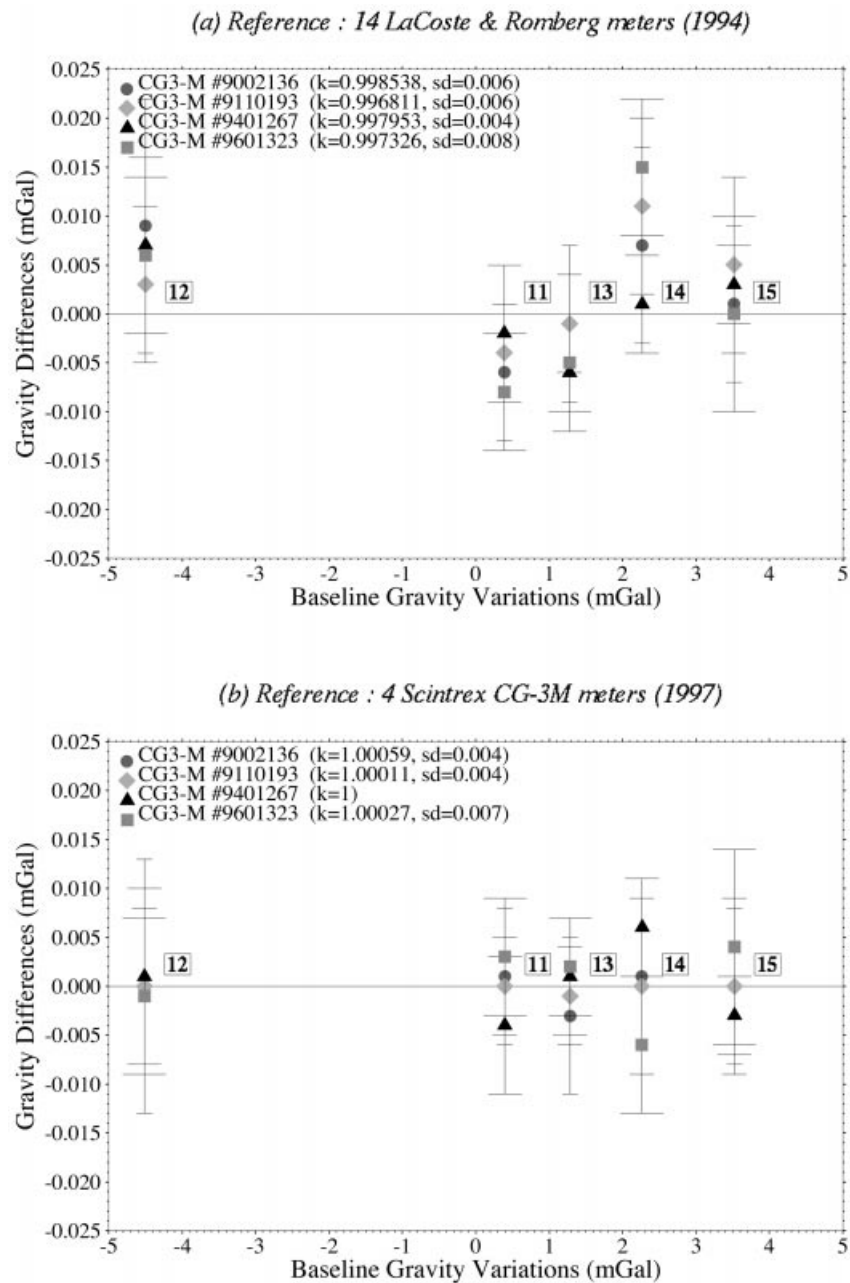

Figure 16. Calibration results for four gravimeters on the calibration baseline of the Bureau International des Poids et Mesures (02/20/97). The coefficients k and sd are the computed gravimetric correction factor and the standard deviation in mGal of the adjustment respectively. The gravity values at the stations numbered 11–15 are referenced to an absolute gravity base station. (a) Deviations obtained with respect to a reference defined with 14 LaCoste & Romberg gravimeters in 1994 (reference defined during the fourth international comparison of absolute gravimeters). (b) Deviations obtained with respect to a reference defined as an average over four Scintrex CG-3M gravimeters (instrument 9408267 used as a reference).

(lower than $5 \mu\text{Gal}$ or $15 \mu\text{Gal}$ for time periods of a few days to a few weeks, respectively). This result is of particular interest in volcano monitoring, where microgravity variations can be observed over very short time periods before and after phases of activity (Rymer & Brown 1989; Rymer 1994, 1995; Jousset *et al.* in press). A more general usage of microgravimeter networks should improve the detection capabilities for volcanic-eruption precursor signals and their understanding.

6.3 Long-term evolution of the instrumental drift

It has been demonstrated that the instrumental drift of Scintrex CG-3/3M gravimeters over time periods of several weeks can be modelled with a quadratic function. This implies that the wavelength of the gravity signal being recorded should not be comparable to that of the quadratic signal characterizing the instrumental drift. If this drift is stable enough, it should be

possible to study long-term gravity variations. In order to quantify better the changes in the instrumental drift of the Scintrex CG-3/3M gravimeters over longer periods of time, the response of two instruments was analysed over time since their date of acquisition. Gravity field values, recorded at the same reference site in Bondy by gravimeters 9002136 and 9408267 are shown in Fig. 17(a). It can be noted that these instruments have drifted by about 1070 mGal over 2400 days and 250 mGal over 700 days, respectively. The corresponding daily averages are 0.45 mGal and 0.36 mGal, respectively. This drift did not occur in a linear manner over time, as demon-

strated by the discrete drift values computed from the corresponding continuous recordings (Fig. 17b). These values, defined over periods of several days, show a sharp variation between the 200th and 300th days of use, followed by a slower and more regular decrease of the drift rate of both instruments. After several years, the values are about 0.25 mGal day⁻¹ and 0.35 mGal day⁻¹ for instruments 9002136 and 9408267, respectively. These values are equivalent to those determined in the framework of this study (Fig. 4 and Table 1). The two instruments have different behaviours: they have drifted in opposite directions since the first phase of utilization (inversion of the

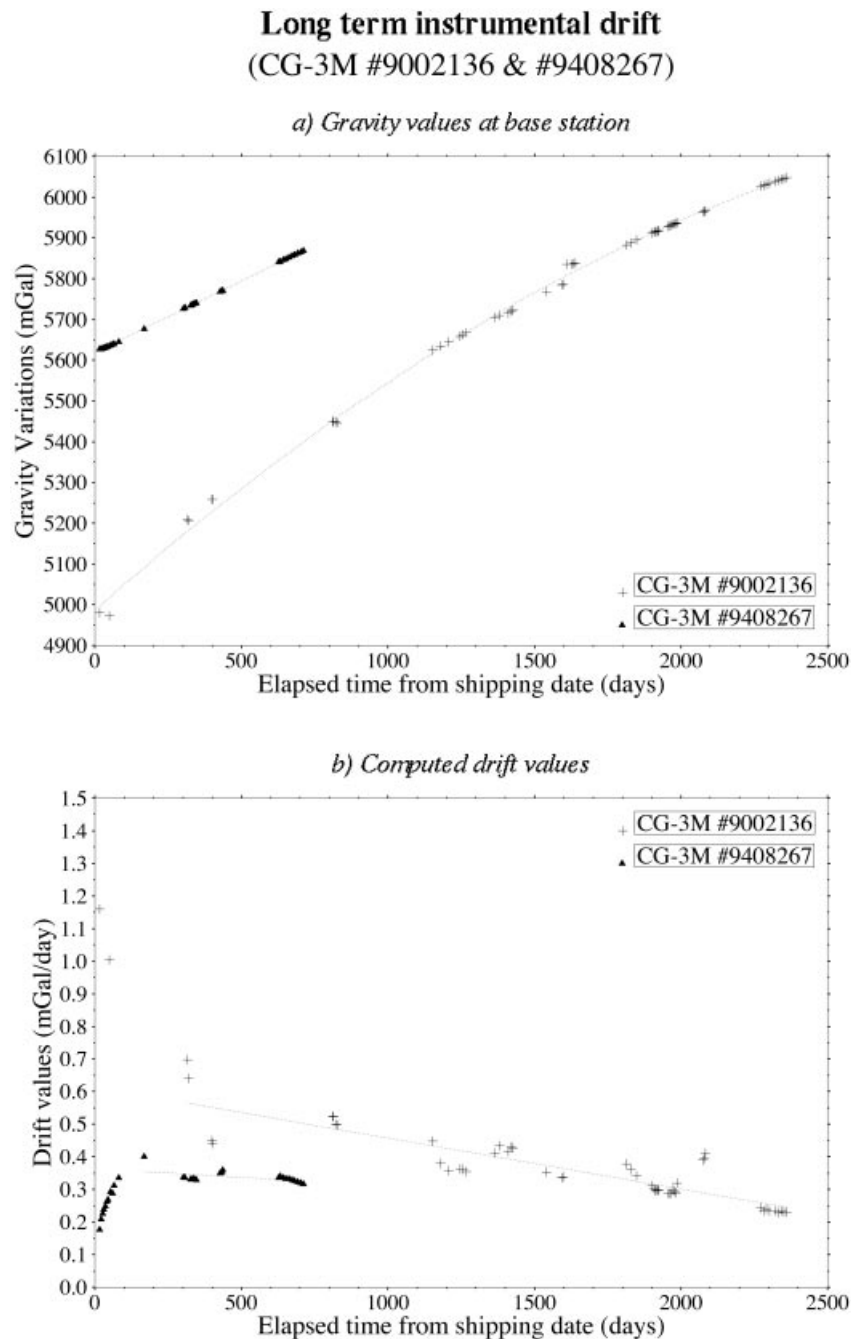

Figure 17. Long-term instrumental drift for the Scintrex CG-3M gravimeters. (a) Gravity field values measured at the reference site in Bondy with instruments 9002136 and 9408267 since their first use. The jump seen around day 1600 follows the opening of the sensor during a control by the manufacturer. (b) Corresponding instrumental drift values computed over continuous recording periods greater than or equal to three days.

Schematic view of the calibration tilt table

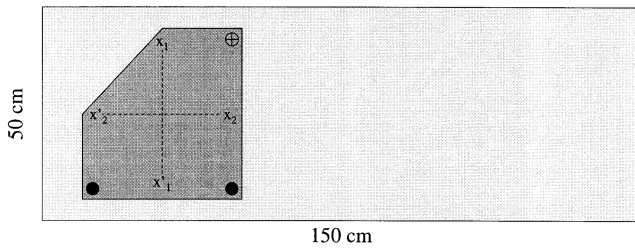

Figure 18. Schematic view of the tilt calibration table. The circled cross indicates the location of the mercury step-bearing. Axes x_1 and x_2 indicate the position of the gravimeter X axis during tests 1 and 2 shown in Fig. 19.

drift for 9408267). These observations confirm that sharp variations in the instrumental drift can occur during the first year of use, as mentioned by the manufacturer (Scintrex 1995). In the long term, the evolution of the instrumental drift is more regular. If a regular instrument calibration is performed, gravimetric variations of longer periods could be also studied through continuous recordings.

6.4 Tiltmeter resolution

It was proved above that the accuracy of the tilt sensor was greater than the proposed standard resolution (1 arcsec). To check the sensitivity of the sensors to a small tilt variation, one gravimeter was placed on a calibration table normally used for the calibration of quartz tilt sensors (P. A. Blum, personal communication). The measurement system, shown in

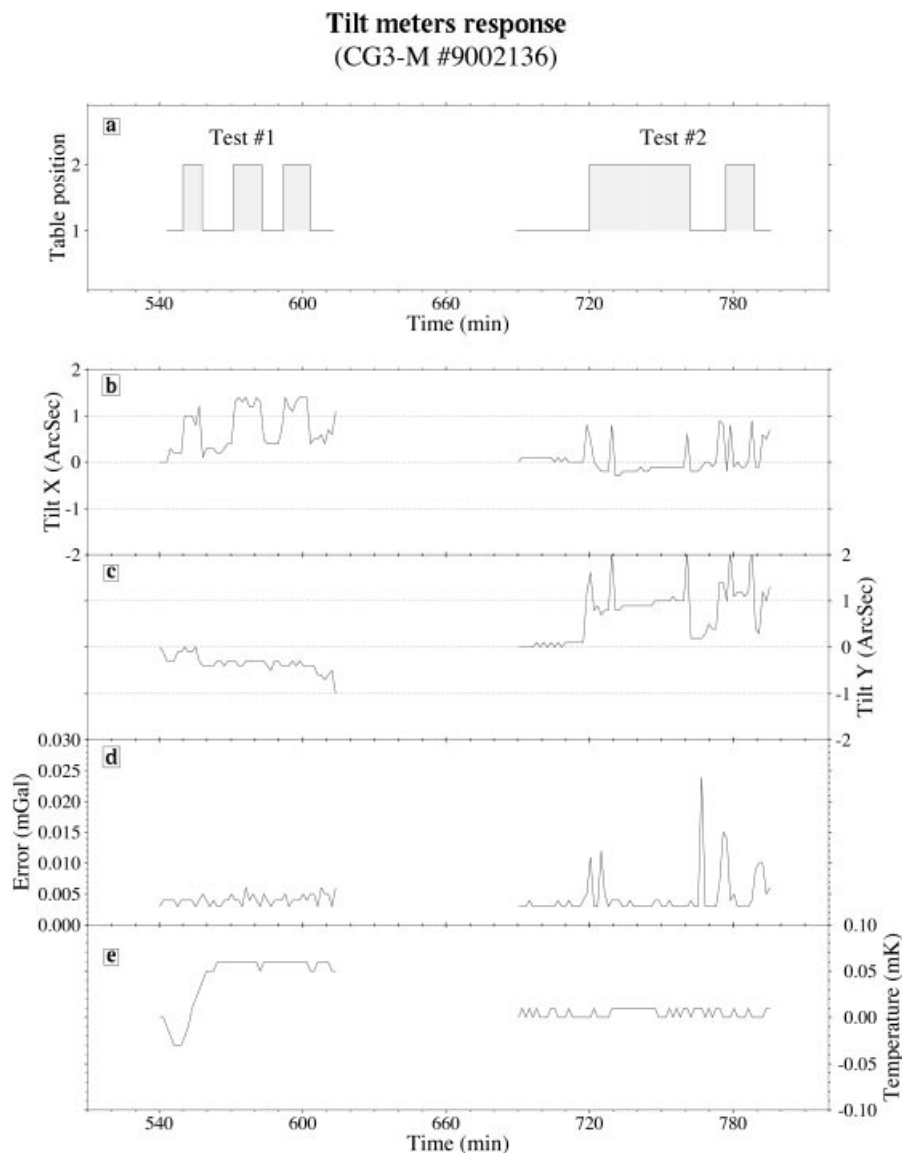

Figure 19. Results of an experimental test on the tilt response of the gravimeter 9002136 (sampling rate=1 reading per 90 sec). Curve a, tilts induced in the X axis (test 1) and the Y axis (test 2) of the gravimeter (see Fig. 18). In both tests, the calibration table was tilted alternately from position 1 (tilt=0) to position 2 (tilt= $4 \mu\text{rad}$). Curve b, tilt response of the gravity meter along the X axis. Curve c, tilt response of the gravity meter along the Y axis. Curve d, standard error of the gravity measurement series. Curve e, internal temperature of the gravimeter.

Fig. 18, includes a table whose tilt can be modified by a mercury step-bearing located under one of the table feet. The tilt of the gravimeter was varied by an amplitude of $4 \mu\text{rad}$ (about 0.82 arcsec) in two perpendicular directions. For each position, several gravity readings were taken in a continuous mode. Fig. 19 shows the results obtained by modifying the tilt alternately along the X and the Y axis of the gravimeter. Despite a slight drift in time, the tiltmeter response is consistent in time and amplitude with the induced tilt variations. The average amplitude of this response is between 0.75 and 0.9 arcsec . This corresponds to a deviation smaller than 10 per cent with respect to the amplitude of the calibration signal. The peaks observed in the tiltmeter response are correlated with an increase of the errors made in the gravity measurements (Fig. 19). These errors can be related to a tiltmeter response to a noise level that was temporarily higher because of the operator's presence and not to the instrumental noise of the sensors. The recording of the internal temperature confirms that no important thermal variation occurred during this test.

This result suggests that the tiltmeters of the Scintrex CG-3M gravimeters are able to record tilt variations of the ground with a resolution of the order of a few μrad . This is of particular interest for geodynamic purposes, where major deformations of the ground surface could be recorded in a continuous mode with this type of instrument. Thus, this parameter can be used both for correcting the gravity signal and for detecting major tilt variations occurring in active zones. Of course, a more precise calibration of these sensors would require a more sophisticated analysis of each of the tilt devices.

6.5 Response to a high seismicity or microseismicity

In order to acquire and interpret continuous data series recorded over active zones, it is necessary for the gravity sensor not to be perturbed by high-frequency or large-amplitude variations that could be related to seismic or volcanic activity (local or regional earthquakes, volcanic tremors, etc.). The behaviour of the Scintrex CG-3/3M gravimeters under such conditions has been verified during several tests. Fig. 20 shows the response to a teleseismic event with a large magnitude (8.2), recorded at the study site in Bondy. The event induces a high-frequency signal with a large amplitude (more than 0.3 mGal) and an increase by a factor 50 of the error in the measurement series. However, this strong perturbation does not induce a modification of the gravimeter response in the long term. Fig. 21 presents two examples of gravity recordings made during a few hours on the Masaya volcano (Nicaragua) during an eruption. In 1993, a new magmatic activity occurred in this volcano, leading to the emergence of a lava lake inside one of the top craters. The signals were recorded at a station located in an active zone (Fig. 21a) near the active crater (less than 200 m away) and at a station located in a stable zone about 3 km away from the crater (Fig. 21b). The recordings show a stable signal even within close range of the active zone. Moreover, in this area, the measurement noise is of the order of $\pm 0.01 \text{ mGal}$; that is, two times greater than that recorded at the station further away, where the attenuation is stronger. It is obvious that this difference in the noise level between active and stable areas is a limiting factor in the accuracy of

Scintrex CG-3M gravity recording of earthquake (Bondy : 48.915N , 2.486E)

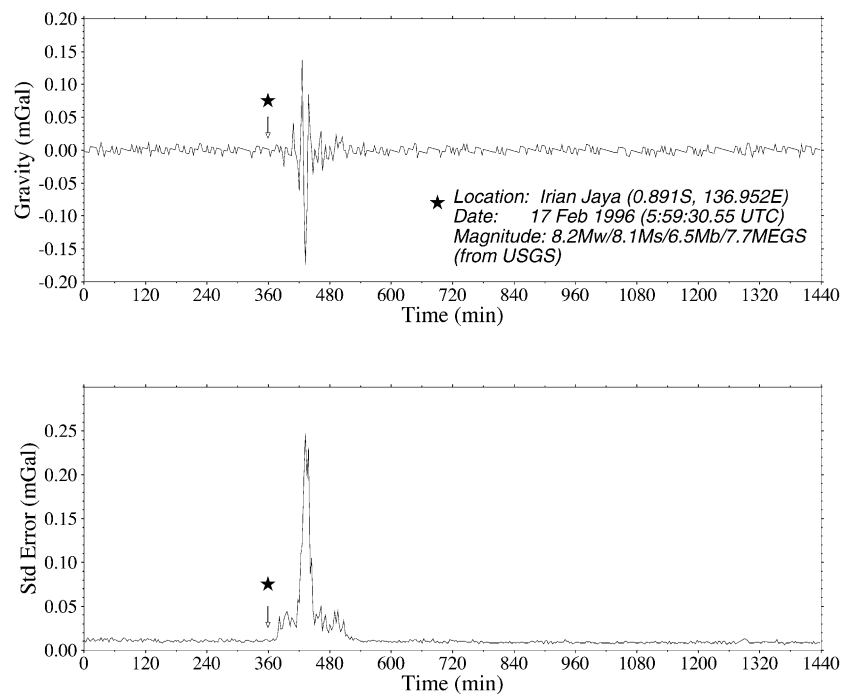

Figure 20. Response of gravimeter 9002136 to a teleseismic event with a large magnitude (8.2), recorded in Bondy (48.915°N , 2.486°E). The residual gravity signal was obtained after removal of a precise Earth tide model and of a linear drift. It can be seen that no significant change occurs in the gravity response (drift value, accuracy) due to the recording of this perturbing signal. (a) Gravity response (sampling rate = 1 reading per 120 s). (b) Corresponding standard error in gravity measurements.

Scintrex CG-3M gravity recordings on active volcano
(Masaya, Nicaragua - November 1993)

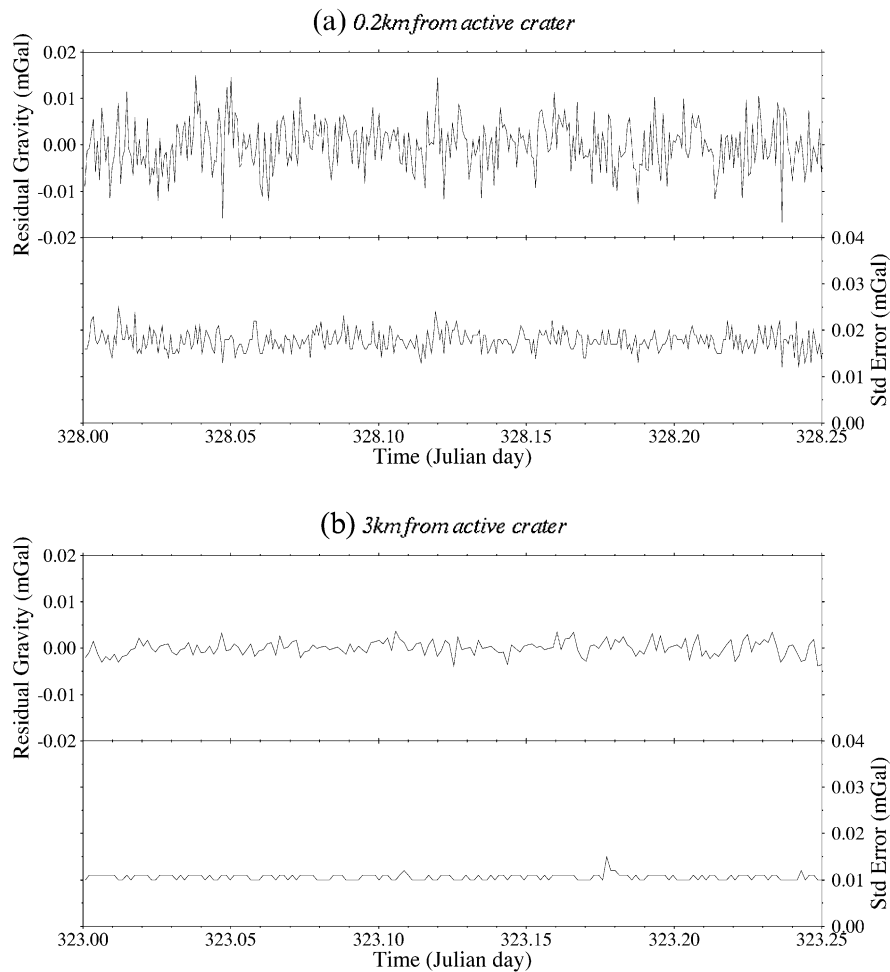

Figure 21. Response of gravimeter 9002136 to a high microseismic activity during a volcanic-activity crisis on the Masaya volcano (Nicaragua) in November 1993 (lava lake activity). The gravity meter was set up for continuous recording on the volcano at two different sites to evaluate its behaviour for continuous recording close to an active volcanic area (sampling rate=1 reading per 60 s). The gravity signals, shown with their standard errors, were corrected using precise Earth tide and drift corrections. The high noise level close to the active crater does not affect the stability of the gravity response compared to that recorded at a remote station. (a) Signal recorded in the active zone, less than 0.2 km away from the crater. (b) Signal recorded in a stable zone, 3 km away from the crater.

the differential recordings that can be obtained in active zones. As we mentioned earlier, the use of the new seismic filter now available on new versions of the CG-3/3M might decrease significantly this limit for highly seismic areas.

7 CONCLUSIONS

Some of the instrumental responses of several Scintrex CG-3M instruments have been studied on the basis of continuous time-series recorded on these new instruments. These meters, placed in similar measurement conditions over several weeks, display relatively homogeneous responses, despite instrumental effects due mainly to the influence of the atmospheric pressure. It has been shown that these effects can easily be corrected during the data post-processing if simultaneous pressure recordings are available. By using networks of microgravity meters simultaneously recording over several weeks, residual variations could be measured with an accuracy between 10 and 15 μGal .

Over shorter periods of time (several days), an accuracy between 5 and 10 μGal could be reached because of the linearity of the instrumental drift over this time interval. The results of the tests on the intrinsic resolution of the tiltmeters show that important variations of the ground surface (greater than a few tens of μrad) can also be detected with devices set up permanently on site.

The study confirms that the technical characteristics and the ease of use of the Scintrex CG-3M gravimeter offer wide potentialities. This is particularly true for in-field continuous recording of gravity variations whose origins are geodynamical or meteorological and whose amplitudes are greater than or equal to a few tens of μGal . For smaller-amplitude phenomena, absolute gravimeters or relative devices of the superconducting type will be preferred because of their higher resolution and their smaller instrumental drift. These results are particularly relevant to the application of microgravimetry to volcanology to detect variations with time of the gravity field, where

amplitudes from several tens to several hundreds of μGal generated by magmatic activity are often observed. Because these variations can precede or occur jointly with eruptive phases, the use of permanent networks of autonomous Scintrex CG-3M gravimeters co-located with permanent GPS stations should allow a better continuous monitoring of the volcanoes. The acquisition of numerical data with such devices allows the implementation of communication systems for remote control of the instruments and the automatic transmission of the data to a remote observatory.

ACKNOWLEDGMENTS

We thank Bernard Ducarme from the Royal Observatory of Belgium for his help in the determination of accurate Earth tide corrections, G. Juste from ORSTOM and P. A. Blum from the Institut de Physique du Globe, Paris, for their technical support, and the Bureau International des Poids et Mesures for access to the reference gravity sites. We thank Florence Rivière and an anonymous reviewer for improving the manuscript. We have also benefited from fruitful discussions with Ivo Bric and Peter Mistry. The figures presented in the paper were produced with the GMT 3.0 software (Wessel & Smith 1995). This study was supported by the French national programme PNRN, the TOA/RED Department of ORSTOM and the Institut de Physique du Globe de Paris (IPGP contribution No. 1556).

REFERENCES

- Becker, M., Balestri, L., Bartell, R., Berrino, G., Bonvalot, S., Diament, M., D'Errico, M., Gerstenecker, C., Gagnon, C., Jousset, P., Kopaev, A., Liard, J., Marson, I., Meurers, B., Nowak, I., Nakai, S., Rehren, F., Richter, B., Schnüll, M., Somerhausen, A., Spita, W., Szatmari, S., Van Ruymbeke, M., Wenzel, H.G., Wilmes, H., Zucchi, M. & Zürn, W., 1995. Microgravimetric measurements at the 1994 International Absolute Gravimeter Intercomparison in Sèvres, France, *Metrologia*, **32**, 145–152.
- Berrino, G., Rymer, H., Brown, G.C. & Corrado, G., 1992. Gravity-height correlations for unrest at calderas, *J. Volc. Geotherm. Res.*, **53**, 11–26.
- Berrino, G., d'Oreye, N., Ducarme, B., Somerhausen, A. & Van Ruymbeke, M., 1995. Monitoring tides and gravity at Mount Etna, *Cahiers du Centre Européen de Géodynamique et de Sismologie*, **8**, 291.
- Bonvalot, S., Métaixian, J.P., Gabalda, G. & Pérez, O., 1995. Gravity and GPS studies at Masaya Volcano (Nicaragua): structural modelling and monitoring volcanic activity, *IUGG XXI General Assembly, Boulder, CO*.
- Bonvalot, S., Diament, M., Deplus, C., Gabalda, G. & Bachèlery P., 1996. A new microgravity network on Piton de la Fournaise volcano, *2nd EVOP Workshop, Santorini, Greece*.
- Budetta, G. & Carbone, D., 1997. Potential application of the Scintrex CG-3M gravimeter for monitoring volcanic activity: results of field trials on Mt. Etna, Sicily, *J. Volc. Geotherm. Res.*, **76**, 199–214.
- De Meyer, F., Ducarme, B. & Elwahabi, A., 1995. Continuous gravity observations at Mount Etna (Sicily), *IUGG XXI General Assembly, Boulder, CO*.
- Diament, M., Jousset, P., Dwipa, S., Duquesnoy, T. & Beauducel, F., 1995. Microgravity and elevation variations monitoring on Merapi Volcano (Indonesia), *IUGG XXI General Assembly, Boulder CO*.
- Diament, M., Bonvalot, S., Jousset, P., Deplus, C. & Gabalda, G., 1997. Microgravity surveys on some active volcanoes: Piton de la Fournaise (Reunion), Merapi (Indonesia), Masaya (Nicaragua) and Soufriere (Guadeloupe), *AGU Chapman Conference on Micro-gravimetry: Instruments, Observations & Applications, San Augustin, Florida*.
- Ducarme, B. & Somerhausen, A., 1997. Tidal gravity recording at Brussels, *Bull. Info. Marées Terrestres*, **126**, 9611–9634.
- Eggers, A.A., 1987. Residual gravity changes and eruption magnitude, *J. Volc. Geotherm. Res.*, **33**, 201–216.
- Gabalda, G. & Bonvalot, S., 1997. *CG3TOOL: an interactive program for Scintrex CG-3/3M gravity data processing (version 2.0)*, *Rapport interne ORSTOM, Bondy*.
- Goodkind, J.M., 1986. Continuous measurements of nontidal variations of gravity, *J. geophys. Res.*, **91**, 9125–9134.
- Groten, E. & Becker, M., 1995. Methods and experiences of high precision gravimetry as a tool for crustal movement detection, *J. Geodyn.*, **19**, 141–157.
- Harrisson, J.C. & Sato, T., 1984. Implementation of electro-static feedback with a LaCoste & Romberg model G gravity meter, *J. geophys. Res.*, **89**, 7957–7961.
- Hinderer, J., Legros, H. & Crossley, D., 1991. Global earth dynamics and induced gravity changes, *J. geophys. Res.*, **96**, 20 257–20 265.
- Hinderer, J., Crossley, D. & Xu, H., 1994. A two years comparison between the French and Canadian superconducting gravimeter data, *Geophys. J. Int.*, **116**, 252–266.
- Hugill, A., 1990. The Scintrex CG-3M Autograv automated gravity meter, description and field results, *SEG Conference, San Francisco*.
- Jousset, P., 1996. Microgravimétrie et gravimétrie en volcanologie: méthodologie et application au volcan Mérapi, Java, Indonésie. *Thèse de Doctorat de l'université Paris 6*.
- Jousset, P., Van Ruymbeke, M., Bonvalot, S. and Diament, M., 1995. Performance of two Scintrex CG3-M gravity meters at the 4th International Absolute Intercomparison, Sèvres, France, *Metrologia*, **32**, 231–244.
- Jousset, P., Dwipa, S., Beauducel, F., Duquesnoy, T. & Diament, M., in press. Temporal gravity at Merapi during the 1993–1995 crisis: an insight into the dynamical behaviour of volcanoes, *J. Volc. Geotherm. Res.*
- Kauffman, R.D. & Doll, W.E. Gravity meter comparison and circular error, *J. Environ. Eng. Geophys.*, in press.
- LaCoste & Romberg, 1991. *Instruction Manual, Model G and D Gravity Meters*, Austin, TX, USA.
- LaCoste & Romberg, 1996. *Instruction Manual, Portable Earth Tide Gravity Meter*, Austin, TX, USA.
- Lambeck, K., 1981. Some geodetic aspects of the plate tectonics hypothesis (review), in *Reference Coordinate Systems for Earth Dynamics*, pp. 87–102, eds Gaposchkin, E.M. & Kolaczek, B., Reidel, Dordrecht.
- Longman, I.M., 1959. Formulas for computing the tidal acceleration due to the moon and the sun, *J. geophys. Res.*, **64**, 2351–2355.
- Merriam, J.B., 1992. Atmospheric pressure and gravity, *Geophys. J. Int.*, **109**, 488–500.
- Rymer, H., 1989. A contribution to precision microgravity data analysis using LaCoste and Romberg gravity meters, *Geophysical J.*, **97**, 311–322.
- Rymer, H., 1994. Microgravity change as a precursor to volcanic activity, *J. Volc. Geotherm. Res.*, **61**, 311–329.
- Rymer, H., 1995. Microgravity monitoring, in *Monitoring Active Volcanoes*, pp. 217–245, eds McGuire, B., Kilburn, C.R. & Murray, J., UCL Press, London.
- Rymer, H. & Brown, G.C., 1986. Gravity fields and the interpretation of volcanic structures: geological discrimination and temporal evolution, *J. Volc. Geotherm. Res.*, **27**, 229–254.
- Rymer, H. & Brown G.C., 1989. Gravity changes as a precursor to volcanic eruption at Poas volcano, Costa Rica, *Nature*, **342**, 902–905.
- Scintrex, 1995. *User's Guide: CG-3/3M Gravity Meter*, Scintrex Ltd, Concord, Ontario, Canada.

- Seigel, H.O., Brcic, I. & Mistry, P., 1993. A high precision, μGal resolution, land gravimeter with worldwide range, in *A Guide to High Precision Land Gravimeter Surveys*, Seigel, H.O. Scintrex Ltd, Concord Ontario, Canada.
- Tilling, R.I., 1989. Measures of little gravity, *Nature*, **342**, 862–863.
- Torge, W., 1981. Gravity and height variations connected with the current rifting episode in northern Iceland, *Tectonophysics*, **71**, 227–240.
- Torge, W., 1989. *Gravimetry*, Walter de Gruyter, Berlin.
- Vaillant, H.D., 1986. An inherently linear electrostatic feedback method for gravity meters., *J. geophys. Res.*, **91**, 10463–10469.
- Van Ruymbeke, M., 1985. Transformation of nine LaCoste & Romberg gravimeters in feedback systems, *Bull. Info. Marées Terrestres*, **93**, 6202–6228.
- Warburton, R.J. & Goodkind, J.M., 1977. The influence of barometric pressure variations on gravity, *Geophys. J. R. astr. Soc.*, **48**, 281–292.
- Wessel, P. & Smith, W.H.F., 1995. New version of the Generic Mapping Tools released, *EOS Trans. Am. Geophys. Un.*, **76**, p329.