



**HAL**  
open science

## Spectral induced polarization of Na-montmorillonite dispersions

Philippe Leroy, Maximilian Weigand, Guillaume Mériquet, Egon Zimmermann, Christophe Tournassat, Fritjof Fagerlund, Andreas Kemna, Johan Alexander Huisman

► **To cite this version:**

Philippe Leroy, Maximilian Weigand, Guillaume Mériquet, Egon Zimmermann, Christophe Tournassat, et al.. Spectral induced polarization of Na-montmorillonite dispersions. *Journal of Colloid and Interface Science*, 2017, 505, pp.1093-1110. 10.1016/j.jcis.2017.06.071 . insu-01546901

**HAL Id: insu-01546901**

**<https://insu.hal.science/insu-01546901v1>**

Submitted on 26 Jun 2017

**HAL** is a multi-disciplinary open access archive for the deposit and dissemination of scientific research documents, whether they are published or not. The documents may come from teaching and research institutions in France or abroad, or from public or private research centers.

L'archive ouverte pluridisciplinaire **HAL**, est destinée au dépôt et à la diffusion de documents scientifiques de niveau recherche, publiés ou non, émanant des établissements d'enseignement et de recherche français ou étrangers, des laboratoires publics ou privés.



Distributed under a Creative Commons Attribution - NonCommercial - NoDerivatives 4.0 International License

# Accepted Manuscript

Regular Article

Spectral induced polarization of Na-montmorillonite dispersions

Philippe Leroy, Maximilian Weigand, Guillaume Mériguet, Egon Zimmermann, Christophe Tournassat, Fritjof Fagerlund, Andreas Kemna, Johan Alexander Huisman

PII: S0021-9797(17)30727-0  
DOI: <http://dx.doi.org/10.1016/j.jcis.2017.06.071>  
Reference: YJCIS 22498

To appear in: *Journal of Colloid and Interface Science*

Received Date: 18 March 2017  
Revised Date: 27 May 2017  
Accepted Date: 20 June 2017

Please cite this article as: P. Leroy, M. Weigand, G. Mériguet, E. Zimmermann, C. Tournassat, F. Fagerlund, A. Kemna, J. Alexander Huisman, Spectral induced polarization of Na-montmorillonite dispersions, *Journal of Colloid and Interface Science* (2017), doi: <http://dx.doi.org/10.1016/j.jcis.2017.06.071>

This is a PDF file of an unedited manuscript that has been accepted for publication. As a service to our customers we are providing this early version of the manuscript. The manuscript will undergo copyediting, typesetting, and review of the resulting proof before it is published in its final form. Please note that during the production process errors may be discovered which could affect the content, and all legal disclaimers that apply to the journal pertain.

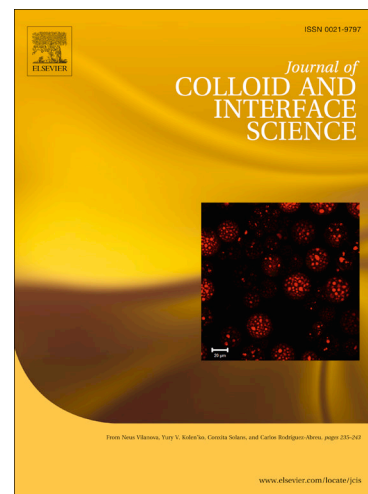

## Spectral induced polarization of Na-montmorillonite dispersions

Philippe Leroy<sup>1,2\*</sup>, Maximilian Weigand<sup>3</sup>, Guillaume Mériguet<sup>4</sup>, Egon Zimmermann<sup>5</sup>,  
Christophe Tournassat<sup>6</sup>, Fritjof Fagerlund<sup>2</sup>, Andreas Kemna<sup>3</sup>, Johan Alexander  
Huisman<sup>7</sup>

<sup>1</sup> BRGM, French Geological Survey, 45060 Orléans, France.

<sup>2</sup> Department of Earth Sciences, Uppsala University, 75236 Uppsala, Sweden.

<sup>3</sup> Department of Geophysics, Steinmann Institute, Bonn University, 53115 Bonn, Germany.

<sup>4</sup> PHENIX, Pierre and Marie Curie University - CNRS, UMR 8234, 75252 Paris, France.

<sup>5</sup> Electronic Systems, ZEA 2, Central Institute of Engineering, Electronics and Analytics,  
Forschungszentrum Jülich, 52425 Jülich, Germany.

<sup>6</sup> Université d'Orléans - CNRS/INSU - BRGM, UMR 7327 Institut des Sciences de la Terre d'Orléans,  
45071 Orléans, France.

<sup>7</sup> Agrosphere institute, IBG 3, Institute for Bio- and Geosciences, Forschungszentrum Jülich, 52425  
Jülich, Germany.

\*Corresponding author and mailing address:

Philippe Leroy

BRGM

3 Avenue Claude Guillemin

45060 Orléans Cedex 2, France

E-mail: p.leroy@brgm.fr

Tel: +33 (0)2 38 64 39 73

*Intended for publication in Journal of Colloid and Interface Science*

## Abstract

Montmorillonite (Mt) clays have a high specific surface area and surface charge, which confer them remarkable adsorption properties. Nevertheless, their electrochemical and aggregation behavior are not completely elucidated because of the complexity of their microstructural and interfacial properties. In this work, the conductive and dispersive properties of Na-Mt suspensions of weight fractions 0.5 to 5.2% were investigated for the first time using the spectral induced polarization method. A four-electrode system was used to reduce errors introduced by electrode polarization and contact resistances. Complex conductivity spectra in the low-frequency range of 0.1 Hz to 45 kHz were successfully described using a triple layer model of the basal surface of Mt and a complex conductivity model that considers conduction of the diffuse layer and polarization of the Stern layer. Aggregate size distributions were inferred from inverted relaxation time distributions. We found that the negative and permanent surface charge of the basal plane of Na-Mt controls its quadrature (imaginary) conductivity, which is not very sensitive to pH and salinity (NaCl) in the 100 Hz to 45 kHz frequency range. For lower frequencies, the sudden increase of the quadrature conductivity at the highest salinities was explained by considering coagulation of Na-Mt particles.

**Keywords:** Na-montmorillonite, dispersions, spectral induced polarization, conductivity, dielectric permittivity, basal plane, surface charge, Stern layer, diffuse layer.

## 1. Introduction

Clay minerals are abundant in regolith and sedimentary rocks [1, 2]. Understanding the electrochemical properties of clays is relevant in environmental geoscience, geotechnics, geothermy, and gas and petroleum exploration [3-7]. Among clays, montmorillonite (Mt) is an important subgroup of smectite [8, 9]. It is the main component of bentonite, which is used as a backfill material for the storage of domestic waste in landfills and of high-level nuclear waste in geological formations [5, 10].

The microstructural and interfacial properties of Mt in water are complex because it forms aggregates constituted of several interacting Mt particles [11, 12]. These particles are made of a succession of TOT layers containing a central octahedral (O) sheet between two inward-pointing tetrahedral (T) sheets (2:1 clay [8]). Their surface charge distribution is heterogeneous. Isomorphic substitution in the solid induces a negative and permanent surface charge of their basal plane (of value between  $-0.15$  and  $-0.1$  C  $m^{-2}$ ) and the presence of protonated oxygen atoms at their edge results in a pH and salinity-dependent surface charge [12-14]. Mt particles have a lamellar shape (their thickness is few nm and their length is hundreds of nm) and hence a high specific surface area (several hundreds of  $m^2 g^{-1}$ ) [10].

Currently, molecular dynamics simulations and surface complexation models may accurately describe the electrochemical properties of the basal plane of Mt particles [14-18]. The electrochemical properties of the edge plane remain partly unknown notably because of the spillover effect of the negative electrostatic potential of the basal surface on the electrostatic potential of the edge surface [13, 19]. The accuracy of the models predictions may decrease significantly when the electrochemical properties of Mt aggregates are investigated because of the interactions between Mt particles [11, 12,

14]. Furthermore, the aggregation behavior of Mt particles remains not completely elucidated [20, 21]. For these reasons, there is a need for laboratory measurements such as complex impedance measurements to evaluate the predictions of molecular dynamics simulations and surface complexation models of Mt dispersions in well-controlled chemical conditions.

Mt dispersions exhibit a gigantic dielectric permittivity when they are influenced by a sinusoidal electrical field in the kHz to MHz frequency range [22]. This phenomenon is a manifestation of the polarization of the electric double layer (EDL) (also named alpha-relaxation [23]) that compensates the surface charge of clay particles [23]. The dielectric permittivity of Mt dispersions has been measured for frequencies superior or equal to kHz with a two-electrode system [22, 24-32]. Nevertheless, little is known about their polarization for lower frequencies because of the problem of electrode polarization [33]. The spectral induced polarization (SIP) method uses a four-electrode system to measure the complex impedance in the mHz to kHz frequency range [34-36]. In contrast to the two-electrode system, the current is injected through two electrodes and the two other electrodes measure the resulting voltage. The two current and potential electrodes are appropriately separated to diminish effects of electrode polarization [37].

To the best of our knowledge, no study has used a four-electrode system to measure the induced polarization of Mt dispersions for frequencies below kHz. In this work, we present complex conductivity measurements on Na-Mt dispersions of weight fractions 0.5 to 5.2% in the 0.1 Hz to 45 kHz frequency range. These measurements were inverted to obtain the relaxation time distributions. They were also interpreted using a surface complexation model of the basal surface of Na-Mt combined with a mechanistic

SIP model that considers conduction of the diffuse layer and polarization of the Stern layer. In the manuscript, the structural and electrical properties of Mt and the complex conductivity model are first explained. Then, the sample preparation and the experimental set-up are presented. Finally, the measured and computed complex conductivities of Na-Mt dispersions are showed and discussed.

## **2. Theoretical background on the properties of montmorillonite and complex conductivity model**

### **2.1. Structural and electrical properties of montmorillonite**

Montmorillonite is a member of the dioctahedral smectite clay group [8, 9]. Mt dispersions contain Mt aggregates made of very elongated particles that are composed of a succession of TOT layers [16, 38]. Each TOT layer has a negative and permanent surface charge at its basal surface ( $\{001\}$  plane) because of the isomorphous substitutions of  $\text{Si}^{4+}$  by  $\text{Al}^{3+}$  and  $\text{Fe}^{3+}$  ions in the tetrahedral sheets and of  $\text{Al}^{3+}$  and  $\text{Fe}^{3+}$  by  $\text{Mg}^{2+}$  and  $\text{Fe}^{2+}$  ions in the octahedral sheet. Most of the isomorphous substitutions occur in the octahedral sheet and the negative surface charge is compensated by cations adsorbed in the interlayer space, sandwiched between two TOT layers, or on the outer basal surface (Fig. 1). The edge surface contains protonated and deprotonated oxygen atoms and has a surface charge that depends on pH and salinity [10, 13, 19].

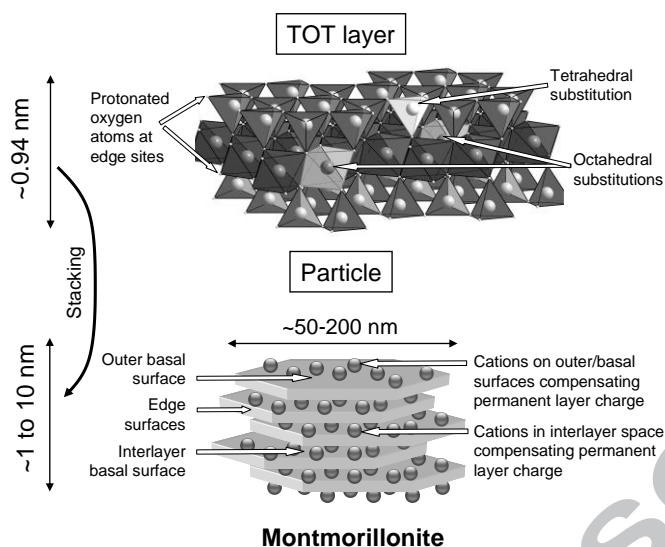

**Fig. 1.** Sketch of the structure of a montmorillonite TOT layer and particle (from Ref. [16] with the permission of the Publisher).

Each TOT layer is very elongated,  $\sim 1$  nm thick and 50–200 nm long [10] (Fig. 1). The surface area of a TOT layer is thus dominated by the contribution of the basal surface, as the edge surface area only represents a minor part of the total surface area. From crystallographic considerations, it can be estimated that the total specific surface area of a Mt TOT layer is about  $780 \text{ m}^2 \text{ g}^{-1}$  [14], from which the edge surface share is about  $10\text{--}30 \text{ m}^2 \text{ g}^{-1}$  and the basal surface share is about  $750\text{--}770 \text{ m}^2 \text{ g}^{-1}$  [39, 40]. The specific surface area of the outer basal surface,  $SS_b^o$ , is related to the number  $n_c$  of TOT layers that are stacked in a single Mt particle (Fig. 1):

$$SS_b^o = \frac{SS_b}{n_c}, \quad (1)$$

where  $SS_b$  is the total specific surface area of the basal surface (in  $\text{m}^2 \text{ g}^{-1}$ ). The number  $n_c$  rarely exceeds 10 in water [14]. According to viscosity and light-transmission



experiments, Na-Mt dispersions in diluted water (ionic strengths typically  $\leq 10^{-3}$  M) contain particles made up of 1–2 TOT layers, whereas Ca-Mt or Mg-Mt dispersions contain particles made up of 6–10 TOT layers [41].

Each Mt particle is surrounded by an EDL that compensates the surface charge not compensated by the counter-ions in the interlayer space [27, 42] (Fig. 2). The EDL of Mt is made of a compact layer containing mostly counter-ions, the Stern layer, and of a diffuse layer containing counter-ions in majority and co-ions [3, 16, 18]. The thickness of the diffuse layer can be considerably larger than the thickness of the Mt particle, e.g., several tens of nanometers in diluted water. The thickness of the diffuse layer decreases significantly (as the inverse of the square root of the ionic strength) when the ionic strength increases because of the compression of the diffuse layer [43, 44]. Ionic interactions in the EDL are dominated by the electrostatic interactions between the external surface of Mt and ions in aqueous solution [43, 45]. Beyond the EDL, there is the neutral water [46].

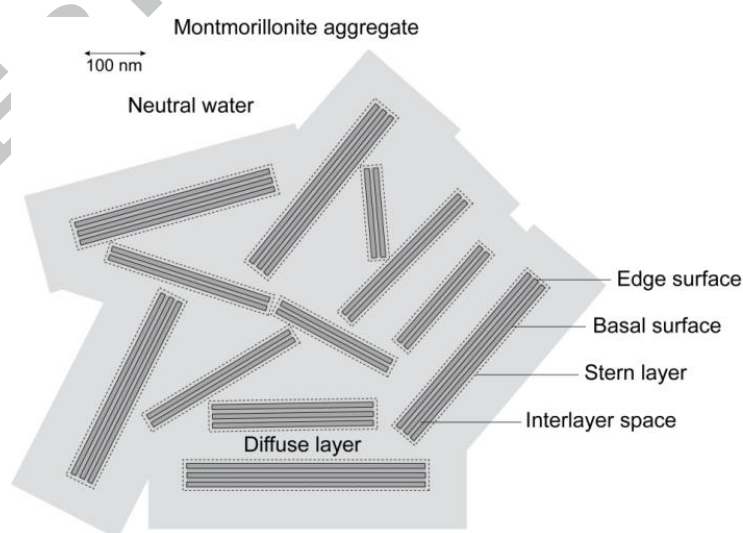

**Fig. 2.** Sketch of a Mt aggregate containing Mt particles surrounded by their Stern and diffuse layer (the thickness of the particles is larger than in reality, from Ref. [16] with the permission of the Publisher).

The dispersion and aggregation of Mt in water are strongly dependent on its surface charge and hence on the water chemical composition [12, 47]. Mt particles can be attracted when their positively charged edge surface interacts with the negatively charged basal surface of another particle (“edge-to-face” interactions favored under acidic conditions [12]). Attractive “Edge-to-edge” interactions may be favored under neutral conditions when the charge of the edge surface is very low because of attractive van der Waals interactions [48]. Repulsive “face-to-face” interactions may be favored under basic conditions because the charge of the edge surface is negative [22]. Even under basic conditions, it has been observed that Na-Mt particles form aggregates in water [26, 28]. This phenomenon can be explained by the presence of a long-range Coulombic attractive force between Na-Mt particles that was not described by the DLVO theory [11]. When the salinity of the aqueous solution reaches the critical coagulation concentration, Mt particles coagulate and form larger and denser Mt aggregates [9, 12, 38].

## 2.2. Complex conductivity model

The conductivity of Na-Mt dispersions was modeled by considering that Na-Mt particles form aggregates containing both neutral and diffuse layer water. We consider thick diffuse layers, that is, diffuse layers larger than the thickness of a Na-Mt particle, and the effect of electro-osmosis on their electrical conductivity. The diffuse layer is assumed to contribute to the volume conductivity and not to fully polarize because the volume of neutral water controlling the diffuse layer polarization is restricted. We consider that most of the counter-charge is located in the Stern layer and that the Stern

layer polarizes. We also neglect the Maxwell-Wagner polarization due to the charge build-up at the boundary between clay and water because of the low solid content of the investigated Na-Mt dispersions (<2% of the total volume) and the low-frequency range of our complex conductivity measurements (Appendix A).

The fraction of the counter-charge in the Stern layer is a parameter of our conductivity model that was directly computed by our surface complexation model. Our conductivity model also depends on the aggregate size distribution (ASD), which was computed by inverting the complex conductivity spectra and assuming a value of the diffusion coefficient of the counter-ions in the Stern layer.

### *2.2.1. Surface complexation model*

The modified triple layer model (TLM) of Leroy et al. [16] was used to compute the electrochemical properties of the Na-Mt particles as a function of the measured cation exchange capacity (CEC) and water chemical composition (Fig. 3). We did not use a surface complexation model for the edge surface of Na-Mt because its surface area (between 10 and 30 m<sup>2</sup> g<sup>-1</sup> [39, 40]) can be neglected compared to the external surface area of the basal surface (between 375 and 750 m<sup>2</sup> g<sup>-1</sup> [10, 41]). In addition, no surface complexation model has been developed yet to describe the Stern layer at the edge surface of Na-Mt [19].

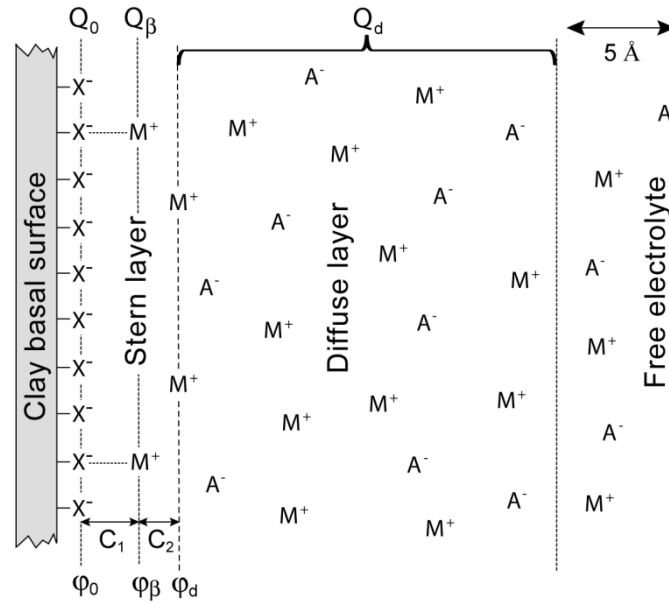

**Fig. 3.** TLM of the basal surface of Na-Mt in contact with a 1:1 electrolyte (e.g., NaCl). The parameters “ $\phi$ ”, “ $Q$ ” and “ $C$ ” stand for the electrical potential, the surface charge density, and the capacitance, respectively (from Ref. [16] with the permission of the Publisher).

The TLM of Leroy et al. [16] describes the sorption of  $\text{Na}^+$  ion in the Stern layer at the basal surface. It was modified to consider the sorption of  $\text{H}^+$  ion [15]. This yields:



where  $>X^-$  are the negative surface sites (resulting from the isomorphous substitutions in the solid), and  $K_{\text{Na}}$  and  $K_{\text{H}}$  are the equilibrium adsorption constants. In Eq. (3),  $\text{H}^+$  ion was assumed to be adsorbed in the Stern layer and not directly on the surface because it may be adsorbed as  $\text{H}_3\text{O}^+$  ions [49, 50].

By combining Eqs. (2) and (3), we obtained:

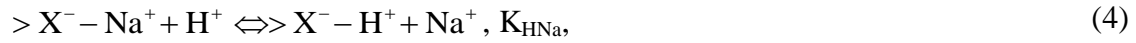

where  $K_{HNa} = K_H / K_{Na}$  is the Gaines and Thomas selectivity coefficient describing the exchange of the  $Na^+$  with the  $H^+$  ion (dimensionless,  $K_{HNa} = 3.16$  [19] and  $K_{Na} = 1.12$  [16] yield  $K_H = 3.55$ ).

The surface charge density at the “0-plane”,  $Q_0$  (in  $C\ m^{-2}$ ) (Fig. 3), was calculated according to the measured CEC (in  $meq\ g^{-1}$ ) and total specific surface area of the basal surface using the following equation [16]:

$$Q_0 = -\frac{e N_A CEC}{10^3 SS_b}, \quad (5)$$

where  $e$  is the elementary charge ( $1.602 \times 10^{-19}$  C) and  $N_A$  is the Avogadro number ( $6.022 \times 10^{23}$   $mol^{-1}$ ).

The fraction of the counter-charge in the Stern layer,  $f_Q$ , is defined by:

$$f_Q = \frac{Q_\beta}{Q_\beta + Q_d}, \quad (6)$$

where  $Q_\beta$  and  $Q_d$  are, respectively, the surface charge densities of the Stern and diffuse layer at the basal surface (Fig. 3). The calculation of the fraction of the counter-charge in the Stern layer is very important to estimate the contributions of the Stern and diffuse layer to the complex conductivity of Na-Mt dispersions.

The interface between the basal surface and neutral water satisfies the electroneutrality condition. This implies:

$$Q_0 + Q_\beta + Q_d = 0, \quad (7)$$

and, by combining Eqs. (6) and (7), we obtained:

$$f_Q = -\frac{Q_\beta}{Q_0}, \quad (8)$$

where  $Q_0$  was calculated according to Eq. (5) and  $Q_\beta$  was computed by the modified TLM of Leroy et al. [16].

### 2.2.2. Water conductivity

We assume that the neutral and diffuse layer water contribute to the in-phase conductivity of the clayey materials [51-57]. The complex conductivity of the water can be described as a function of the angular frequency  $\omega$  (in  $\text{rad s}^{-1}$ ,  $\omega = 2\pi f$  with  $f$  the frequency in Hz or  $\text{s}^{-1}$ ) by considering the conduction and the displacement currents [58]. This yields:

$$\sigma_w^*(\omega) = \sigma_w + i\omega\varepsilon_w, \quad (9)$$

where  $\sigma_w$  is the Direct Current (DC) conductivity (in  $\text{S m}^{-1}$ ) and  $\varepsilon_w$  is the dielectric permittivity (in  $\text{F m}^{-1}$ ) of water (subscript “w” for water), and  $i$  is the imaginary number ( $i^2 = -1$ ). Water dielectric permittivity is written as  $\varepsilon_w = \varepsilon_r\varepsilon_0$  where  $\varepsilon_r$  is the relative dielectric permittivity of water (79.55 for Milli-Q water at a pressure of 1 bar and temperature of 295 K, which is the average temperature of our complex conductivity measurements) and  $\varepsilon_0$  is the dielectric permittivity of vacuum ( $8.854 \times 10^{-12} \text{ F m}^{-1}$ ) [59].

The DC conductivity of the water was calculated using an arithmetic formula [60, 61]:

$$\sigma_w = \Omega_n^w \sigma_n^w + \Omega_d^w \sigma_d^w, \quad (10)$$

where  $\Omega_n^w$ ,  $\sigma_n^w$ , and  $\Omega_d^w$ ,  $\sigma_d^w$ , are the volume fractions (dimensionless) and the volume conductivities (in S m<sup>-1</sup>) of the neutral and diffuse layer water, respectively. The volume fractions are given by (Appendix A):

$$\Omega_n^w = 1 - \frac{\delta_s}{V_t} \left( \frac{1}{10^3 \rho_s} + SS_o 2\chi_d \right), \quad (11)$$

$$\Omega_d^w = \frac{\delta_s}{V_t} SS_o 2\chi_d, \quad (12)$$

where  $\delta_s$  is the solid mass (in g),  $V_t$  is the total volume of the dispersion (in m<sup>3</sup>),  $\rho_s$  is the volumetric mass density of a TOT layer (in kg m<sup>-3</sup>),  $SS_o$  is the outer specific surface area of the Na-Mt particles (in m<sup>2</sup> g<sup>-1</sup> of solid,  $SS_o \cong SS_b^o$ ), and  $2\chi_d$  is the assumed thickness of the diffuse layer (in m) [45]. The parameter  $\chi_d$  is the Debye length, which was calculated as a function of the water chemical composition using:

$$\chi_d = \sqrt{\frac{\varepsilon_w k_B T}{e^2 10^3 N_A \sum_{i=1}^N z_i^2 C_i^w}}, \quad (13)$$

where  $k_B$  is the Boltzmann constant ( $1.381 \times 10^{-23}$  J K<sup>-1</sup>),  $T$  is the temperature (in K),  $N$  is the number of the different ionic species,  $z_i$  is the ion valence, and  $C_i^w$  is the ion concentration (in M) in the neutral water. In Eq. (13), the water chemical composition was calculated according to the known concentrations of added NaCl and HCl electrolyte and the concentrations of ions released from the contact of Na-Mt with water (Eqs. (B1)–(B4)).

Ions in neutral water electromigrate under the applied sinusoidal electric field as long as the frequency is sufficiently low (<GHz [62]). The conductivity of the neutral water,  $\sigma_n^w$ , was calculated as a function of the water chemical composition using [63]:

$$\sigma_n^w = e10^3 N_A \sum_{i=1}^N z_i \beta_i^w C_i^w, \quad (14)$$

where  $\beta_i^w$  is the mobility (in  $\text{m}^2 \text{s}^{-1} \text{V}^{-1}$ ) of ion  $i$  in neutral water, which was corrected to the temperature  $T$  of the complex conductivity measurements using [64]:

$$\beta_i^w(T) = \beta_i^w(T_0)[1 + \mathcal{G}_w(T - T_0)], \quad (15)$$

where  $T_0 = 298 \text{ K}$  and  $\mathcal{G}_w \cong 0.0227 \text{ K}^{-1}$  (considering the difference of water viscosity at  $T$  and  $T_0$  [59, 65, 66]). The ion mobility at  $T_0$  was calculated using the Nernst-Einstein equation  $\beta_i^w(T_0) = (ez_i/k_B T_0)D_i^w(T_0)$  and the measured self-diffusion coefficient of ion  $i$  at  $T_0$  in diluted water,  $D_i^w(T_0)$  (in  $\text{m}^2 \text{s}^{-1}$ ), reported in the phreeqc.dat database [65]. The ion mobilities in neutral water used in our conductivity model were reported in Table 1.

**Table 1.** Ion mobilities in neutral water.

Ion	$\beta_i^w$ ( $10^{-8} \text{ m}^2 \text{ s}^{-1} \text{ V}^{-1}$ )	
	$T = 298 \text{ K}$	$T = 295 \text{ K}$
$\text{Na}^+$	5.18	4.83
$\text{Cl}^-$	7.90	7.37
$\text{H}^+$	36.25	33.81
$\text{OH}^-$	20.52	19.14
$\text{Mg}^{2+}$	2.75	2.56
$\text{H}_3\text{SiO}_4^-$	4.28	3.99
$\text{SO}_4^{2-}$	4.17	3.89



The volume conductivity of the diffuse layer was written as [16, 51, 53]:

$$\sigma_d^w = e10^3 N_A \sum_{i=1}^N z_i B_i^d C_i^w \exp\left(-\frac{q_i \varphi_m}{k_B T}\right), \quad (16)$$

where  $B_d$  is the effective mobility of the ions in the diffuse layer (in  $\text{m}^2 \text{s}^{-1} \text{V}^{-1}$ ),  $q_i = \pm e z_i$  is the ion charge (in C) where “+” and “-” stand for cations and anions, respectively, and  $\varphi_m$  is the average electrical potential in the diffuse layer of the dispersion (in V). The potential  $\varphi_m$  was calculated as a function of the water chemical composition and volumetric excess of charge of the diffuse layer (Eq. (C19)). The effective ion mobility in the diffuse layer was calculated according to [16]:

$$B_i^d = \beta_i^d \pm \beta_{eo}^d \cong \beta_i^w \pm \beta_{eo}^d, \quad (17)$$

$$\beta_{eo}^d = \frac{\varepsilon_w}{\eta_w} (\varphi_m - \varphi_d), \quad (18)$$

where  $\beta_i^d$  is the electromigration and  $\beta_{eo}^d$  is the electroosmotic mobility (in  $\text{m}^2 \text{s}^{-1} \text{V}^{-1}$ ) of the hydrated ions in the diffuse layer [6, 67, 68]. The parameter  $\eta_w$  is the dynamic viscosity of water ( $9.548 \times 10^{-4} \text{ Pa s}$  at a pressure of 1 bar and temperature  $T$  of 295 K [66]) and  $\varphi_d$  is the electrical potential at the onset of the diffuse layer. For instance, in the case of a difference of electrical potential of 25 mV between  $\varphi_m$  and  $\varphi_d$  at  $T = 295$  K, Eq. (18) yields  $\beta_{eo}^d \cong 1.7 \times 10^{-8} \text{ m}^2 \text{s}^{-1} \text{V}^{-1}$ , which is in the same order of magnitude than the ion mobilities due to electromigration (Table 1).

### 2.2.3. Conductivity of the Na-Mt aggregates

We consider that the polarization of the Stern layer controls the imaginary conductivity of the dispersion because most of the counter-charge is located in the Stern layer [3, 15-18, 51] and the volume of neutral water necessary for the full polarization of the diffuse layer is limited by the large volume of diffuse layer [51-55]. We assume that the diffuse layer affects the polarization of the Stern layer. Indeed, the diffuse layer must polarize to compensate the polarization of the Stern layer in order to ensure electroneutrality of the clay/water interface. We follow the work of Lyklema et al. [69] who described the effect of the diffuse layer on the Stern layer polarization. In their model, the diffuse layer decreases the relaxation time of the polarized Stern layer (Fig. 4).

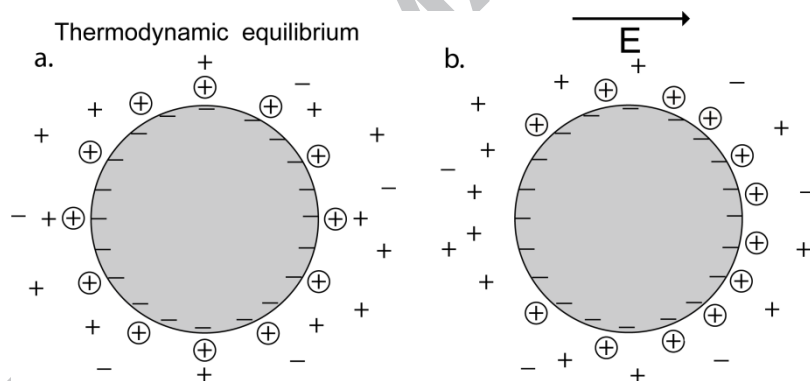

**Fig. 4.** Sketch of the electrochemical polarization of the Stern and diffuse layer around a spherical particle according to the polarization model of Lyklema et al. [69]. (a.) The EDL is in thermodynamic equilibrium in the absence of applied electrical field. (b.) Under the influence of the sinusoidal electrical field, as long as its frequency is sufficiently low, counter-ions and co-ions electromigrate in the Stern and diffuse layer along the particle surface. Counter-ions in the diffuse layer shorten the pathway of the counter-ions in the Stern layer to ensure the overall electroneutrality of the solid/water interface. Counter-ions and co-ions diffuse back to try to reach their initial

concentration at thermodynamic equilibrium. A relaxation time is associated with the polarization of the Stern layer [70].

We consider the polarization of spherical and very porous Na-Mt aggregates of different sizes whose surface area is considerably increased by the external surface area of the Na-Mt particles. We do not consider the polarization of the Na-Mt particles separately. Describing the conduction and polarization a Na-Mt particle is very challenging because the shape of a Na-Mt particle is very elongated (aspect ratio between 10 and 100 [10]) and its diffuse layer is thick. For these reasons, the partial differential equations describing the complex conductivity of a Na-Mt particle (such as the Navier-Stokes and Poisson-Nernst-Planck equations [71]) must be solved numerically and cannot be easily combined with a code inverting the shape of conductivity spectra. In addition, the quadrature conductivity response of a Na-Mt particle may only occur in the kHz frequency range, and quadrature conductivity measurements in the lower frequency range may only be explained by considering the polarization of Na-Mt particles in contact with each other.

The model of Lyklema et al. [69] gives a single Debye-type conductivity response for one aggregate, which, convoluted by the aggregate size distribution, gives a generalized Debye-type conductivity response [72]. This conductivity response can be directly compared to the conductivity response inferred from the Debye decomposition approach that was used to invert the complex conductivity spectra (this will be explained in more detail in section 2.2.5).

The complex conductivity of the aggregates can be described as a function of the angular frequency considering the conduction and the displacement currents. This implies:

$$\sigma_s^*(\omega) = \sigma_s(\omega) + i\omega\varepsilon_s, \quad (19)$$

where  $\sigma_s$  is the surface conductivity and  $\varepsilon_s$  is the dielectric permittivity of the aggregates (subscript “s” for surface), which can be calculated as a function of the volumetric mass density  $\rho_s$  using  $\varepsilon_s \cong \alpha\rho_s\varepsilon_0$ . The empirical parameter  $\alpha = 0.00191 \text{ m}^3 \text{ kg}^{-1}$  can be used in absence of conducting materials, such as magnetic or metallic minerals, and Fe Ti sulfides oxides such as ilmenite [73]. Robinson [74] reported  $\varepsilon_s \cong 5.5\varepsilon_0$  for Mt using time domain reflectometry.

The surface conductivity of the aggregates was computed according to (Appendix D):

$$\sigma_s(\omega) = \frac{2}{3}\Omega_w\beta_s f_Q Q_V \sum_{k=1}^L f(d_k) \frac{i\omega\tau_k}{1+i\omega\tau_k}, \quad (20)$$

where  $\Omega_w$  is the porosity,  $\beta_s$  is the mobility of the counter-ions in the Stern layer (in  $\text{m}^2 \text{ s}^{-1} \text{ V}^{-1}$ ),  $Q_V$  is the excess of charge per water volume (in  $\text{C m}^{-3}$ ), and  $L$  is the number of effective diameters  $d_k$  (in m) of the Na-Mt aggregates. The parameter  $f(d_k)$  is the discretized aggregate size distribution and  $\tau_k$  is the relaxation time of the polarized Stern layer (in s). In Eq. (20), the porosity  $\Omega_w$  was calculated from (Appendix C):

$$\Omega_w = \frac{\rho_s(1-w_D)}{w_D\rho_w + \rho_s(1-w_D)}, \quad (21)$$

where  $w_D$  is the weight fraction of the dispersion and  $\rho_w$  is the volumetric mass density of water (1000 kg m<sup>-3</sup> for Milli-Q water at a temperature of 298 K and pressure of one bar).

The surface mobility of Na<sup>+</sup> in the Stern layer (Eq. (20)) was calculated from its diffusion coefficient  $D_S$  (in m<sup>2</sup> s<sup>-1</sup>) computed by molecular dynamics (MD) simulations (carried out at a temperature  $T_0$  of 298 K [17, 18]). We obtained  $\beta_{\text{Na}^+}^S(T_0) = 2.6 \times 10^{-8}$  m<sup>2</sup> s<sup>-1</sup> V<sup>-1</sup> by considering that the diffusion coefficient of Na<sup>+</sup> in the Stern layer is half its value in neutral water. The diffusion coefficient was converted to the surface mobility according to the Nernst-Einstein equation. The surface mobility was also corrected to the temperature  $T$  of the complex conductivity measurements using [64]:

$$\beta_S(T) = \beta_S(T_0)[1 + \mathcal{G}_S(T - T_0)], \quad (22)$$

where  $\mathcal{G}_S \cong 0.04 \text{ K}^{-1}$  according to surface conductivity data inferred from electrical conductivity measurements on shaly sandstones and bentonite suspensions [64]. We obtained  $\beta_{\text{Na}^+}^S = 2.2 \times 10^{-8} \text{ m}^2 \text{ s}^{-1} \text{ V}^{-1}$  for  $T = 295 \text{ K}$ .

In Eq. (20), the volumetric excess of charge was described by (Appendix C):

$$Q_V = -\rho_s \left( \frac{1 - \Omega_w}{\Omega_w} \right) 10^3 SS_o Q_0. \quad (23)$$

The discretized ASD (Eq. (20)) is normalized to unity, hence:

$$\sum_{k=1}^L f(d_k) = 1. \quad (24)$$

The relaxation time  $\tau_k$  (Eq. (20)) was written as [75]:

$$\tau_k = \frac{1}{2\pi f_k} = \frac{d_k^2}{8D_S M} = \frac{d_k^2 |q|}{8k_B T \beta_S M}, \quad (25)$$

$$M = 1 + \frac{q Q_\beta}{k_B T C_d}, \quad (26)$$

$$C_d = -\frac{\partial Q_d}{\partial \varphi_d} = \sqrt{\frac{\epsilon_w}{2k_B T}} \frac{\sum_{i=1}^N q_i 1000 N_A C_i^w \exp\left(-\frac{q_i \varphi_d}{k_B T}\right)}{\sqrt{\sum_{i=1}^N 1000 N_A C_i^w \left[\exp\left(-\frac{q_i \varphi_d}{k_B T}\right) - 1\right]}}, \quad (27)$$

where  $f_k$  is the relaxation frequency of the polarized Stern layer (in Hz),  $M$  (dimensionless) is a parameter characterizing the effect of the diffuse layer on the Stern layer polarization ( $M \geq 1$ ) (Fig. 4), and  $q$  (in C) is the charge of the counter-ions in the Stern layer. The parameter  $q$  is written as  $q = \pm ez$  where  $z$  is the average valence of the counter-ions, and “+” or “-” stand for cations or anions in majority in the Stern layer, respectively. The  $M$  parameter was computed using the modified TLM of Leroy et al. [16].

#### 2.2.4. Conductivity of the Na-Mt dispersions

Following Vinegar and Waxman [57], we consider that the complex conductivity of the dispersions is the sum of the complex conductivity of the water and of the aggregates.

We can make this assumption because the M-W polarization can be neglected for our SIP experiments. This implies:

$$\sigma^*(\omega) = \sigma_w^*(\omega) + \sigma_s^*(\omega). \quad (28)$$

By combining Eqs. (9), (19), (20), and (28), we obtained for the complex conductivity of the dispersions:

$$\sigma^*(\omega) = \sigma_w + \frac{2}{3} \Omega_w \beta_s f_Q Q_V \sum_{k=1}^L f(d_k) \frac{i\omega\tau_k}{1+i\omega\tau_k} + i\omega(\varepsilon_s + \varepsilon_w). \quad (29)$$

The last term of Eq. (29) can be neglected because of the low-frequency range of the complex conductivity measurements (from 0.1 Hz to 45 kHz). It results that Eq. (29) can be rewritten in the form of a generalized Debye model, which describes the complex conductivity  $\sigma^*$  by a superposition of elementary Debye polarization terms [72, 76-78]:

$$\sigma^*(\omega) = \sigma_\infty + (\sigma_0 - \sigma_\infty) \sum_{k=1}^L \frac{f(d_k)}{1+i\omega\tau_k}, \quad (30)$$

$$\sigma_0 = \sigma_w, \quad (31)$$

$$\sigma_\infty = \sigma_w + \frac{2}{3} \Omega_w \beta_s f_Q Q_V, \quad (32)$$

with  $\sigma_0$  and  $\sigma_\infty$  being the low and high-frequency limit of the in-phase conductivity, respectively. In Eq. (31), neutral and diffuse layer water contribute to the low-frequency limit of the in-phase conductivity while water and Stern layer contribute to the high-frequency limit of the in-phase conductivity (Eq. (32)).

The complex conductivity spectra were inverted using the Debye decomposition approach and the following equation to obtain the aggregate size distribution in Eq. (30) [76, 77]:

$$\sigma^*(\omega) = \sigma_\infty \left( 1 - \sum_{k=1}^L \frac{m_k}{1+i\omega\tau_k} \right), \quad (33)$$

with  $m_k$  being the  $k$ -th chargeability (dimensionless), which is a measure of the relative strength of this polarization term (weight factor). The relaxation time  $\tau_k$  is inversely correlated to the frequency maximum of the quadrature conductivity of the  $k$ -th polarization term. Relaxation times are evenly distributed in the relaxation time range defined by the minimal and maximal data frequencies, extended by two orders of magnitude to either side.

The inversion algorithm produces relative weights  $m_k(\tau_k)$  for all relaxation times  $\tau_k$ , which form the relaxation time distribution (RTD). Integral, summarizing parameters can be derived from the RTD. These integral parameters summarize certain spectral features of the conductivity spectra [78]:

- The total chargeability  $m_{tot} = \sum_{k=1}^L m_k$  accounts for the polarization magnitude in the measured frequency range.
- The normalized total chargeability  $m_{tot}^n = \sigma_0 m_{tot}$  is commonly considered as a more appropriate measure of the strength of the polarization compared to the total chargeability [77, 79].
- The median relaxation time  $\tau_{50}$  is the relaxation time at which 50% of the total chargeability is reached.
- The mean relaxation time  $\tau_{mean}$  is the chargeability-weighted logarithmic mean value of the RTD:  $\tau_{mean} = \exp(\sum_{k=1}^L m_k \log(\tau_k) / \sum_{k=1}^L m_k)$ .

One important advantage of the DD scheme over more traditional phenomenological models such as the Cole-Cole model [80] is that it can describe a wide variety of different shapes of the quadrature conductivity spectra without any manual tuning (such as the need to predetermine the number of polarization peaks before fitting). Also, in



case no polarization peaks are present in the measured complex conductivity spectra, characteristic changes can still be detected using the integral parameters mentioned before.

According to Eqs. (30)–(33), the discretized ASD was expressed as a function of the inverted chargeability distribution. We obtained:

$$f(d_k) = \frac{m_k}{\sum_{k=1}^L m_k} = \frac{m_k}{m_{tot}}, \quad (34)$$

where  $d_k = \sqrt{8D_S M \tau_k}$  according to Eq. (25) and  $m_{tot} = (\sigma_\infty - \sigma_0) / \sigma_\infty$  [81]. Therefore, two parameters, the diffusion coefficient of the counter-ions in the Stern layer,  $D_S$ , and the effect of the diffuse layer on the Stern layer polarization,  $M$ , must be known to convert relaxation time distributions into aggregate size distributions.

### 3. Materials and methods

#### 3.1. Properties of Kunipia-F montmorillonite

The Na-Mt dispersions were prepared using Kunipia-F (Kunimine Industries Co., Ltd, Japan), which is a sodium montmorillonite containing 95 weight per cent (wt%) of montmorillonite [82] (the remaining 5 wt% is made of silica materials). Kunipia-F contains traces of gypsum that may release sulfates in water [83].  $\text{Na}_{0.86}\text{Ca}_{0.06}\text{Mg}_{0.014}[\text{Al}_{3.14}\text{Fe}^{3+}_{0.20}\text{Fe}^{2+}_{0.04}\text{Mg}_{0.62}]^{\text{VI}}[\text{Si}_{7.80}\text{Al}_{0.20}]^{\text{IV}}\text{O}_{20}(\text{OH})_4$  is the chemical formula of Kunipia-F [84]. Its CEC, determined by the hexamminecobalt chloride method, is  $1.15 \text{ meq g}^{-1}$  with the following initial distribution of exchangeable cations: Na 91%, Ca 8%, K 1% [84, 85]. The measured volumetric mass density of dry Kunipia particles is  $2710 \text{ kg m}^{-3}$  [85].

### 3.2. Preparation of the Na-Mt dispersions

Raw Kunipia-F powders were dispersed in Milli-Q water under vigorous mechanical agitation and sonication for 3 min at 25 kHz. The clay fraction of Kunipia-F (size  $<2 \mu\text{m}$ ) was collected by wet gravity sedimentation applying the Stokes' law on a diluted suspension with volume concentration of 0.4%. The suspension was then allowed to stand and the discharging of the fraction  $<2 \mu\text{m}$  was made to a height and duration determined by Stokes' law for an equivalent spherical diameter. Filtered Kunipia-F dispersions were oven-dried during two hours at a temperature of  $200^\circ\text{C}$  to obtain Na-Mt powders. Such high temperature was chosen to dehydrate completely Na-Mt without dehydroxylating it [86]. Different amounts of Na-Mt powders were mixed with Milli-Q water to obtain Na-Mt dispersions of weight fractions 0.5 to 5.2%. The measured pH of the Na-Mt dispersions was  $10.2 \pm 0.2$ . The pH of water in contact with Na-Mt is basic because of the sorption of the  $\text{H}^+$  ion on the surface of Mt [13, 87, 88]. The pH of the 1% Na-Mt dispersions was adjusted to  $7.3 \pm 0.4$  and  $5.5 \pm 0.4$  by adding acid (HCl). The salinity of the 1% and 1.5% Na-Mt dispersions was also increased by adding NaCl. We obtained added NaCl concentrations of  $10^{-4}$  to  $0.05 \text{ mol L}^{-1}$  (M).

### 3.3. Complex conductivity measurements

#### 3.3.1. Experimental set-up

Spectral induced polarization measurements consist of imposing a sinusoidal current  $I$  (in A) at a given frequency (usually from 1 mHz to 10 kHz) using two current electrodes and measuring the resulting voltage  $U$  (in V) between two non-polarizing

potential electrodes. According to Ohm's law, the complex impedance of the medium

$Z^*$  (in  $\Omega$ ) is:

$$Z^*(\omega) = \frac{U(\omega)}{I(\omega)} = |Z^*(\omega)|e^{i\phi(\omega)}, \quad (35)$$

where  $\phi$  is the phase shift between the injected current and measured voltage (in rad).

The complex conductivity  $\sigma^*(\omega)$  is related to  $Z^*(\omega)$  by a cell constant  $k$  (in  $\text{m}^{-1}$ ),

$\sigma^*(\omega) = k/[Z^*(\omega)]$ . The cell constant is calculated using  $k = l/S$  where  $l$  is the

distance between the two potential electrodes (in m) and  $S$  is the cross-sectional area of the cylindrical sample holder (in  $\text{m}^2$ ) [89, 90]. The cell constant was calculated as 273

$\text{m}^{-1}$  considering a radius  $r$  of 1.3 cm for the cylindrical sample holder ( $S = \pi r^2 \cong 5.3 \text{ cm}^2$ )

and a distance  $l$  of 14.5 cm between the two potential electrodes.

The complex conductivity can be written as [57]:

$$\sigma^*(\omega) = \sigma'(\omega) + i\sigma''(\omega) = |\sigma(\omega)|e^{i\varphi(\omega)}, \quad (36)$$

$$\varphi = \tan^{-1} \left[ \frac{\sigma''(\omega)}{\sigma'(\omega)} \right] \cong \frac{\sigma''(\omega)}{\sigma'(\omega)}, \quad (37)$$

where  $\sigma'$  is the in-phase conductivity,  $\sigma''$  is the quadrature conductivity, and  $\varphi = -\phi$

is the phase angle of the complex conductivity, i.e., the negative of the phase shift

between the injected current and resulting voltage [53, 57]. The in-phase conductivity is

sensitive to the conduction currents and the quadrature conductivity is sensitive to the

polarization currents in the medium [53, 54]. The last approximation in the second part

of Eq. (37) holds for a phase magnitude smaller than 100 mrad [53]. The phase angle

$\varphi(\omega)$  defines the ratio of the polarization to the conduction currents.

The effective conductivity,  $\sigma_{ef}$ , and relative dielectric permittivity,  $\varepsilon_{ef}$ , are [53, 58, 91]:

$$\sigma_{ef} = \text{Re}(\sigma^*) = \sigma', \quad (38)$$

$$\varepsilon_{ef} = \frac{1}{\varepsilon_0} \text{Im}\left(\frac{\sigma^*}{\omega}\right) = \frac{\sigma''}{\varepsilon_0 \omega}. \quad (39)$$

SIP measurements were carried out at a temperature of  $22 \pm 1$  °C using four brass electrodes, a sample holder and the ZEL-SIP-04 system built at Forschungszentrum Jülich GmbH including a function generator (Agilent 33120A), a measurement amplifier, an ADC card, and a PC-based measurement control system [37, 92] (Fig. 5). The length of the cylindrical sample holder made of polymethyl methacrylate (PMMA) is 30 cm, with an inner diameter of 2.6 cm. The two current electrodes are located at the top and bottom of the sample holder (electrodes 1 and 4). The two potential electrodes are located between the two current electrodes (electrodes 2 and 3) at a height of 7.75 cm and 22.25 cm from the base of the sample holder. All electrodes have a diameter of 0.6 cm and cable glands with an inner diameter of 0.7 cm are used to enable a water-tight electrode contact with the sample. The potential electrodes are retracted by 1.4 cm (twice the inner diameter of the cable gland) to avoid electrode polarization during the SIP measurements [93].

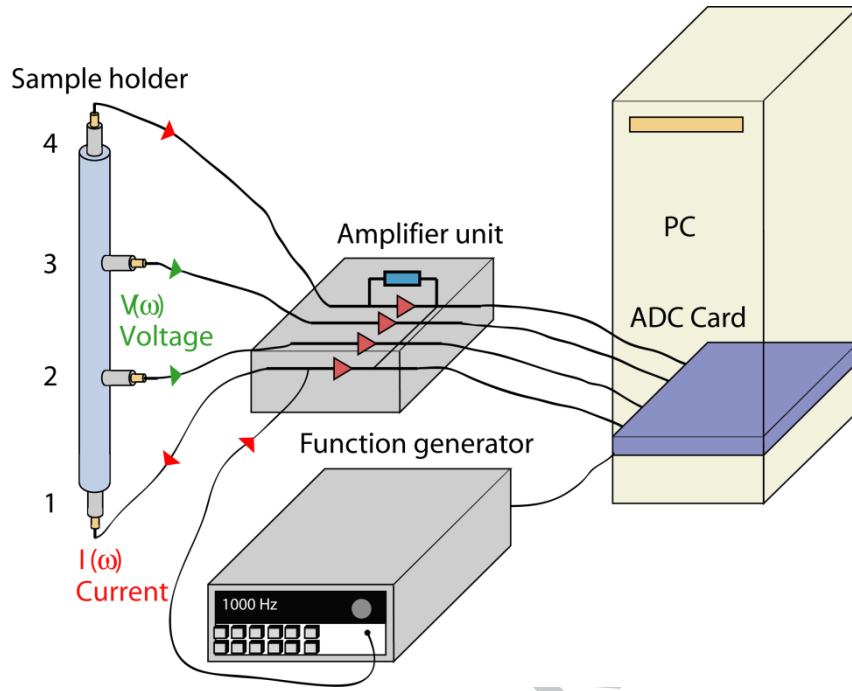

**Fig. 5.** Sketch of the four brass electrodes, the sample holder, and of the ZEL-SIP-04 system for spectral induced polarization measurement (modified from Zimmerman et al. [37]).

Besides the data corrections reported in Zimmerman et al. [48], measured voltages were corrected for the impedances of the potential electrodes that are known to affect measurement accuracy in the kHz range according to [94]:

$$U(\omega) = V_2(\omega)(1 + Z_{e2}i\omega C_v) - V_3(\omega)(1 + Z_{e3}i\omega C_v), \quad (40)$$

where  $U$  is the corrected voltage between the two potential electrodes (electrodes 2 and 3),  $V_{2,3}$  are the measured electrical potentials at electrode 2 and 3, respectively,  $Z_{e2,3}$  are the impedances of electrode 2 and 3, respectively, and  $C_v$  is the input capacitance of the amplifiers (in pF,  $C_v = 4.5$  pF in our experiment) (Fig. 5). Impedances of the

potential electrodes were estimated using SIP measurements with switched current and potential electrodes (i.e., reciprocal measurements) [94].

## 4. Comparison with experimental data

### 4.1. Modeling strategy and parameters values

The complex conductivity and triple layer model were written in Matlab R2013a and the Debye decomposition approach was written in the Python programming language. While the aggregate size distribution inferred from the DD approach determines the shape of the modeled complex conductivity spectra, the mechanistic complex conductivity model determines their magnitude. Fig. 6 summarizes the main features of the modeling approach. During the inversion procedure, 195 relaxation times were inverted ( $L = 195$ ). The complex conductivity of the Na-Mt dispersions was computed as a function of the weight fraction of Na-Mt, the water chemical composition (Eqs. (B1)–(B4)), and the ASD inferred from the DD approach (Eqs. (25) and (34)) according to Eqs. (10)–(18), (21)–(27) and (30)–(32).

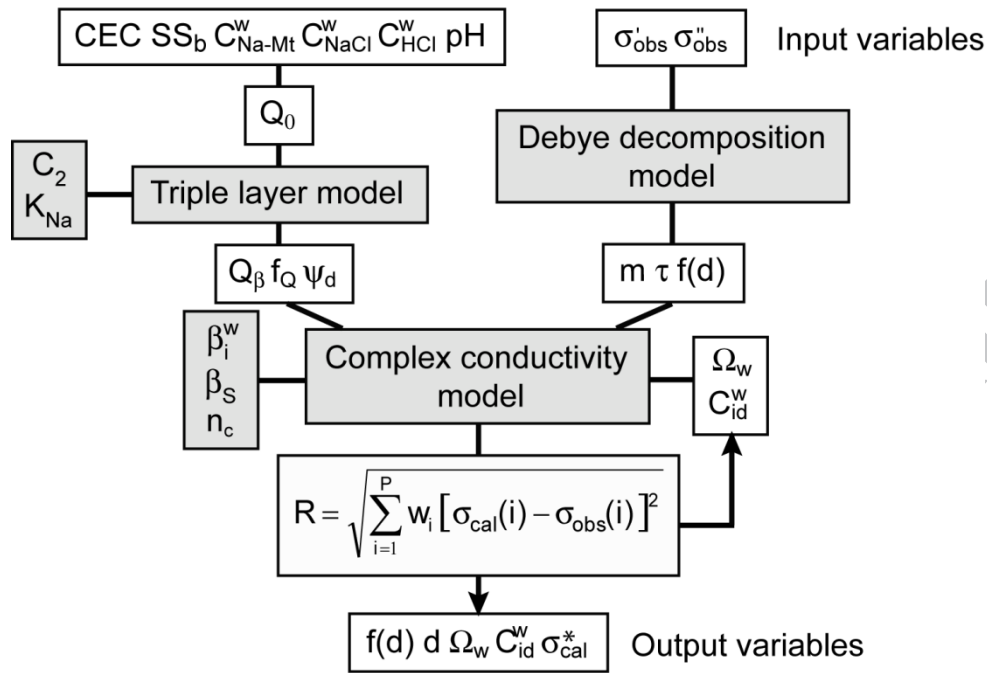

**Fig. 6.** Sketch summarizing the modeling strategy used to interpret complex conductivity spectra of Na-Mt dispersions (the inversion procedure used by the DD approach is not explained here, for more details, read Ref. [76]).

The parameter values of the complex conductivity model were reported in Table 1 and Table 2. Using  $CEC = 1.15 \text{ meq g}^{-1}$  and  $SS_b = 750 \text{ m}^2 \text{ g}^{-1}$ , we obtained for the surface charge density of the basal surface  $Q_0 = -0.15 \text{ C m}^{-2}$ . The computed values of  $M$  were not sensitive to the water chemical composition and were equal to 4. This value of  $M$  reveals that the decrease of the relaxation time of the polarized Stern layer by the diffuse layer is significant. The computed fraction of the counter-charge in the Stern layer,  $f_Q = 0.6$ , shows that the majority of the counter-charge at the basal surface is located in the Stern layer. The sorption of  $H^+$  ion in the Stern layer does not influence significantly the calculations of  $M$  and  $f_Q$  in the pH range 5.5 to 10.2.

**Table 2.** Parameters values of the complex conductivity model.

Param.	Meaning	Value
$T$	Temperature of the conductivity measurements	295 K
$\rho_s$	Dry volumetric mass density of Kunipia Mt	2710 kg m <sup>-3a</sup>
CEC	Cation exchange capacity	1.15 meq g <sup>-1b</sup>
$SS_b$	Specific surface area of the basal surface	750 m <sup>2</sup> g <sup>-1c</sup>
$n_c$	Number of TOT layers per Na-Mt particle	2 <sup>d</sup>
$SS_o$	Outer specific surface area	375 m <sup>2</sup> g <sup>-1e</sup>
$Q_0$	Surface charge density	-0.15 C m <sup>-2f</sup>
$M$	Diffuse layer effect on Stern layer polarization	4 <sup>g</sup>
$f_Q$	Fraction of the counter-charge in the Stern layer	0.6 <sup>h</sup>
$\beta_s$	Mobility of the Na <sup>+</sup> ion in the Stern layer	2.2×10 <sup>-8</sup> m <sup>2</sup> s <sup>-1</sup> V <sup>-1i</sup>

<sup>a</sup> From Massat et al. [85].

<sup>b</sup> From Theng et al. [84].

<sup>c</sup> From Tournassat et al. [14], taking the lowest value.

<sup>d</sup> From Schramm and Kwak [41] who considered  $n_c \in [1-2]$ .

<sup>e</sup> Considering  $SS_o \cong SS_{bo}$  and  $SS_{bo} = SS_b / n_c$  (Eq. (1)).

<sup>f</sup> From the reported CEC and  $SS_b$  values using Eq. (5).

<sup>g, h</sup> From the modified TLM of Leroy et al. [16].

<sup>i</sup> Calculated according to the value of  $\beta_{Na^+}^S$  inferred from molecular dynamics simulations [17, 18] corrected of the temperature during the conductivity measurements (Eq. (22)).

For each SIP measurement at a given Na-Mt weight fraction and water chemical composition, the a-priori value of the porosity of the aggregates,  $\Omega_w$ , was computed (Eq. (21)), and this parameter was optimized by matching the predictions of the complex conductivity model to the quadrature conductivity measurements. We also carried out lixiviation experiments on Kunipia Mt to measure the concentrations of ions released from the contact of Na-Mt with water. Results were reported in Tables A1 and



A2 (Supporting Information file) and show that  $\text{Na}^+$ ,  $\text{H}_3\text{SiO}_4^-$  (dissolved  $\text{SiO}_2$ ) and  $\text{SO}_4^{2-}$  ions are mostly released into water. Despite the dissolution of Na-Mt for basic pH, we consider that the Stern layer remains populated by  $\text{Na}^+$  ions because the concentration of  $\text{Na}^+$  ions is considerably larger than the concentrations of  $\text{Mg}^{2+}$ ,  $\text{Ca}^{2+}$  or  $\text{K}^+$  ions (Table A2). From the lixiviation experiments, we assumed a-priori that  $C_{id}^w = 1$  mM [88, 95]. The parameter  $C_{id}^w$  was adjusted only according to in-phase conductivity measurements of basic Na-Mt dispersions ( $\text{pH} \geq 9.3$ ). For neutral and acid pH ( $\text{pH} = 7.3$  and  $5.5$ ), the concentration of  $\text{Cl}^-$  ions in neutral water due to the addition of HCl,  $C_{\text{Cl}^-}^w$ , was also adjusted according to in-phase conductivity measurements (a-priori values were taken from the known concentrations of added HCl) (Tables A3 and A4).

As  $\Omega_w$ ,  $C_{id}^w$ , and  $C_{\text{Cl}^-}^w$  can be adjusted independently to quadrature or in-phase conductivity measurements ( $C_{id}^w$  for basic pH,  $C_{\text{Cl}^-}^w$  for neutral and acid pH), the gradient method was used to optimize these parameters. A cost function  $R$  between calculated and measured real or imaginary conductivity (in a least squares sense) was minimized:

$$R = \sqrt{\sum_{i=1}^P w_i [\sigma_{cal}(i) - \sigma_{obs}(i)]^2}, \quad (41)$$

where  $P$  is the number of frequencies investigated by each SIP measurement,  $w_i$  is a weighting coefficient (we took  $w_i = 1$ ), and  $\sigma_{cal}$  and  $\sigma_{obs}$  are the calculated and measured real or imaginary conductivity, respectively.

#### 4.2. Effects of particle concentration on complex conductivity

The in-phase and quadrature conductivity, phase of the complex conductivity, effective dielectric permittivity, and computed aggregate size distributions of Na-Mt dispersions of weight fractions 0.5, 1, 1.5 and 5.2% were presented in Fig. 7. The theoretical limit of accuracy of the measured phase shift of the ZEL-SIP-04 system, 0.1 mrad, was indicated by the dotted line (Fig. 7c). The measurement uncertainties displayed by the error bars in Fig. 7 were estimated by calculating the standard deviations of the parameters using repeated conductivity measurements of the same experiment. Negative phase values, and derived quantities such as imaginary conductivity and dielectric permittivity, were omitted from the log-log plots. For frequencies below 10 Hz, only quadrature conductivity, phase and effective dielectric permittivity measurements of 1 and 5.2% dispersions were reported and show consistent trends in agreement with measurements for higher frequencies.

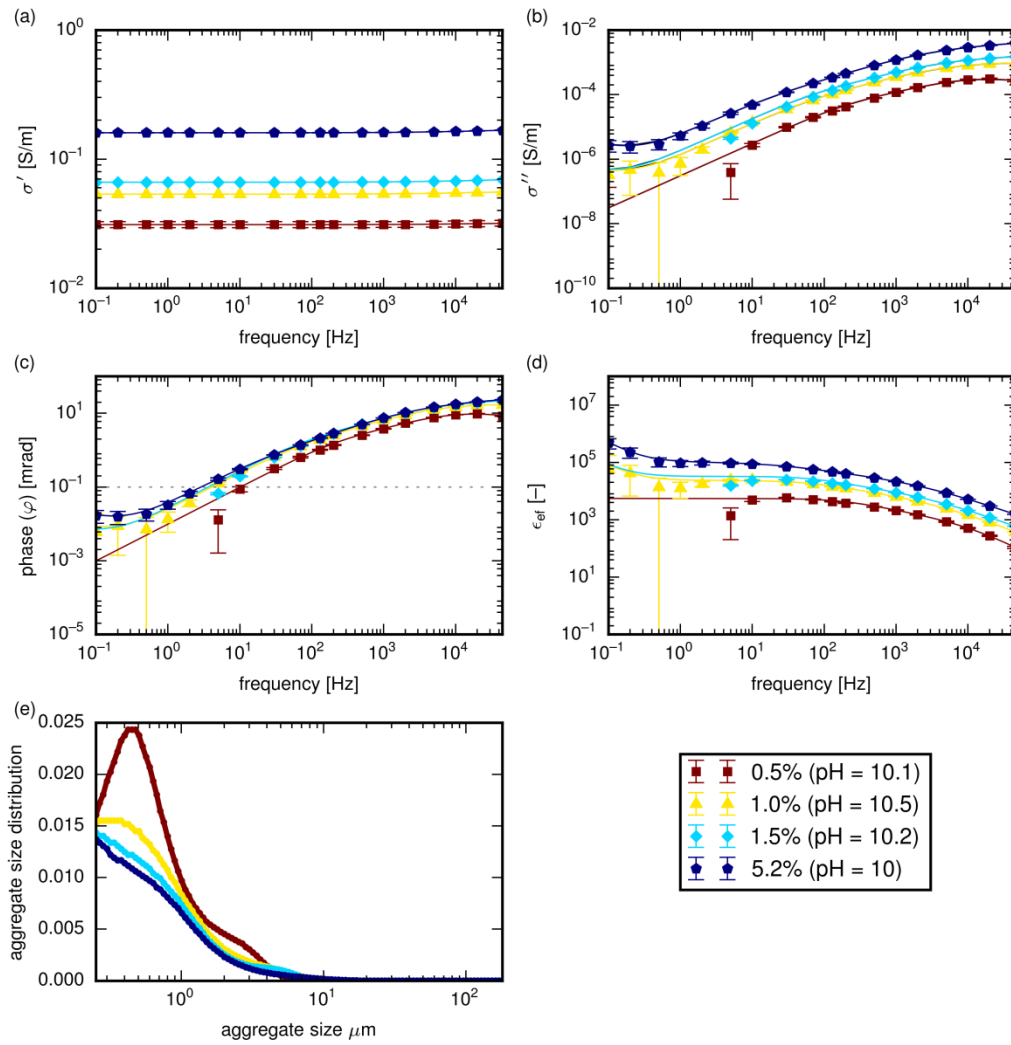

**Fig. 7.** In-phase conductivity (a), quadrature conductivity (b), phase (c), effective dielectric permittivity (d) as a function of frequency, and computed aggregate size distributions (e) of Na-Mt dispersions of weight fractions 0.5, 1, 1.5, and 5.2%. Symbols are experimental data and lines are the calculations from the complex conductivity model.

The quadrature conductivity increases significantly with frequency because of the polarization of more smaller Na-Mt aggregates (Figs. 7b and 7e) [22, 38]. The smaller the aggregate, the lower its relaxation time, and the higher its relaxation frequency contributing to quadrature conductivity (Eqs. (25) and (30)) [22, 51, 53]. The complex

conductivity model reproduces very well the measurements using the aggregate size distributions presented in Fig. 7e. [22, 51, 53], which is in the range 0.3–5  $\mu\text{m}$ , in agreement with centrifugal sedimentation, dynamic light scattering, and transmission electron micrograph measurements [12, 26] (Fig. 7e). ASD for sizes lower than 300 nm were not reported because they correspond to quadrature conductivity data for frequencies superior to 45 kHz interpolated by the DD approach. Aggregate size distributions also show two peaks around 400–500 and 300–400 nm for respectively 0.5% and 1% dispersions. These peaks correspond to the diameters of Na-Mt aggregates containing only a few dispersed Na-Mt particles or even to the lengths of Na-Mt particles [10, 12, 24, 26, 38, 96]. The size of the aggregate corresponding to the peak also decreases when the weight fraction increases because particles are closer together and the diffuse layer between them may be more compressed [28]. However, the peaks should be interpreted with care because they correspond to relaxation frequencies between 11.7 and 18.2 kHz (Eq. (25)). The SIP measurements above 10 kHz may have significant uncertainty (not evident from error bars in the log-log plots) due to the four-electrode set-up and the approximate correction for the contact impedances of the potential electrodes [94]. ASD also broadens when the particle concentration increases because of the polarization of more particles of different sizes and orientation [28].

In-phase, quadrature conductivity and dielectric permittivity increase quasi-linearly with the amount of particles (Figs. 7a,b,d and Fig. A1 of Supplementary Information). We explained this observation by the absence of strong electrostatic interactions between Na-Mt particles at pH = 10.2 [22] and by the increase of the surface area and volumetric excess of charge of the aggregates, whose electrochemical properties are dominated by the basal plane of surface charge density  $Q_0 = -0.15 \text{ C m}^{-2}$  (Eqs. (C2)–(C5); Table A4). Normalized total chargeability inferred from the DD approach and describing the

strength of the polarization,  $m_{tot}^n$ , also increases quasi-linearly with the amount of particles (Fig. A2 of Supplementary Information). The mean relaxation time of the dispersions (from DD) was not sensitive to their weight fraction because Na-Mt particles do not coagulate (Fig. A2) [38]. This observation also supports our assumption that the polarization of the Stern layer at the basal surface of Na-Mt may dominate the polarization of the dispersions. Indeed, one would expect that the relaxation time of the fully polarized diffuse layer (volume diffusion mechanism) decreases when the particle concentration increases [97].

Fig. 7c shows that the in-phase conductivity of 1, 1.5 and 5.2% Na-Mt dispersions is strongly related to their quadrature conductivity because the phase is not very sensitive to their weight fractions (at least for the 100 Hz to 45 kHz frequency range;  $\varphi \cong \sigma''/\sigma'$ , Eq. (37)) [52-55]. Only a slight increase of the phase is observed when particle concentration increases. This effect is more pronounced when the weight fraction increases from 0.5 to 1 %. This observation was explained by the conductivity of the neutral water, which may control the in-phase conductivity  $\sigma'$  of the 0.5% dispersions and by the Na-Mt conductivity, which may control the in-phase and quadrature conductivity of the 1 to 5.2% dispersions.

The relative dielectric permittivity, which depends on the ratio of the imaginary conductivity to the angular frequency (Eq. (39)), also increases with the particle concentration and is very high ( $>10^3$ ) for frequencies inferior to kHz (Fig. 7d). This result suggests that the electrochemical polarization of Na-Mt dispersions occurs not only in the frequency range kHz to GHz, as previously shown by dielectric permittivity measurements with a two-electrode set-up [22, 24-26, 28, 29, 31, 32], but also in the lower Hz to kHz frequency range. Polarization in the low-frequency range may be

expected as Na-Mt particles, even dispersed, form very porous aggregates polarizing over longer distances than individual clay particles [11, 38] (Fig. 2).

#### 4.3. Effect of salinity on complex conductivity

When  $10^{-4}$  to 0.06 M NaCl were added to the Na-Mt dispersions, the pH of 1% and 1.5% Na-Mt dispersions were reduced from  $10.2 \pm 0.2$  to  $10.1 \pm 0.2$  and to  $9.8 \pm 0.5$ , respectively. The in-phase and quadrature conductivity, phase, effective dielectric permittivity, and computed aggregate size distributions were presented in Figs. 8 and 9. Except for 1.5% dispersions containing 0.059 M added NaCl, quadrature conductivity, phase, and dielectric permittivity measurements for frequencies below 10 Hz have significant uncertainties because phases are below the accuracy limit of the ZEL-SIP-04 system (0.1 mrad).

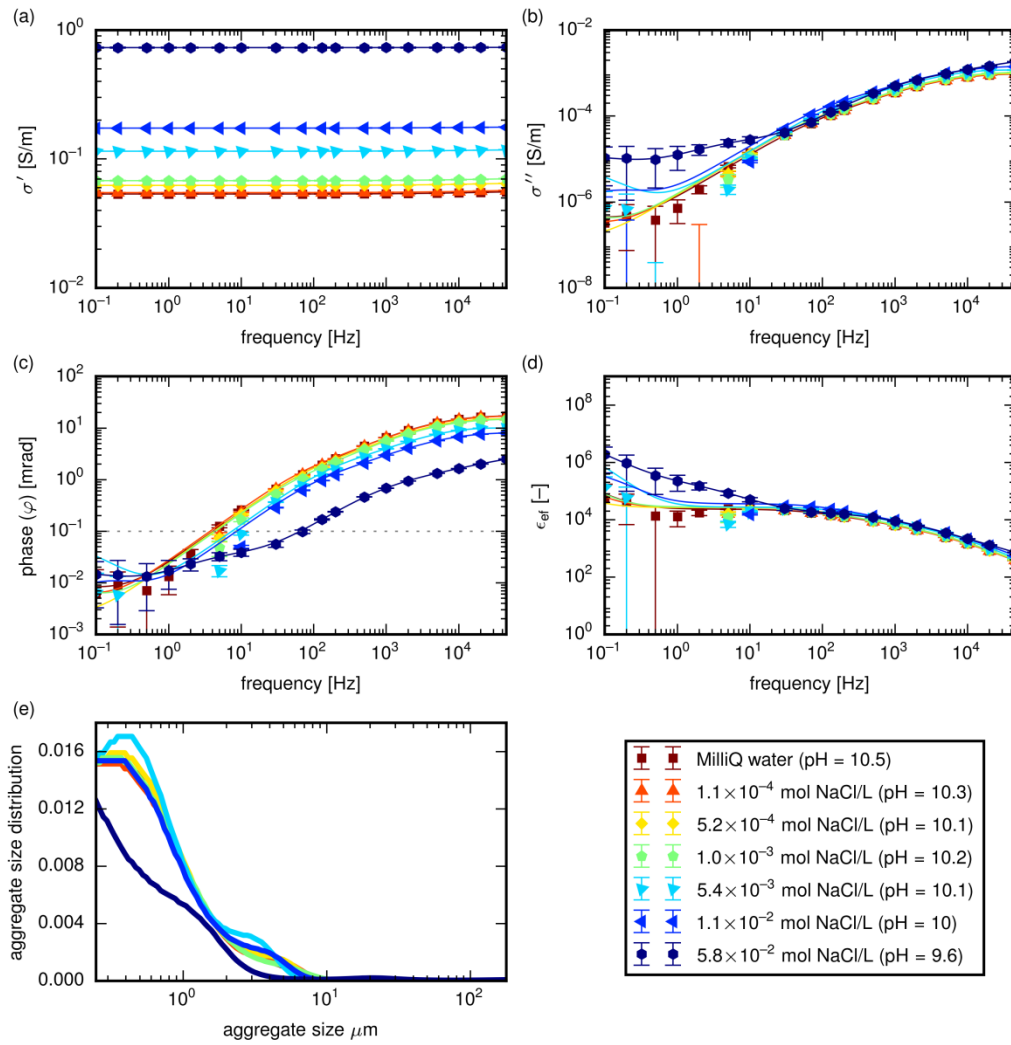

**Fig. 8.** In-phase conductivity (a), quadrature conductivity (b), phase (c), effective dielectric permittivity (d) as a function of frequency, and computed aggregate size distributions (e) of 1% Na-Mt dispersions at different added NaCl concentrations. Symbols are experimental data and lines are calculations from the complex conductivity model.

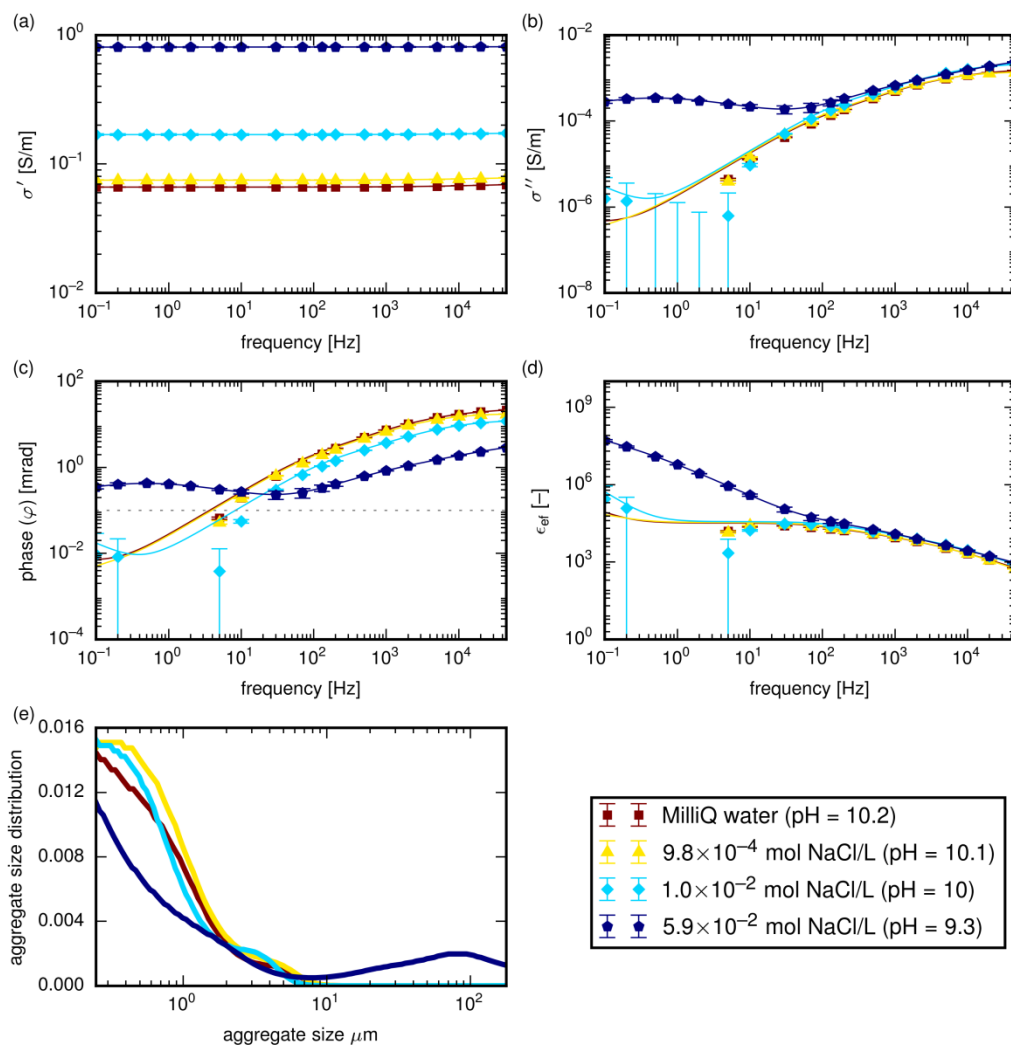

**Fig. 9.** In-phase conductivity (a), quadrature conductivity (b), phase (c), effective dielectric permittivity (d) as a function of frequency, and computed aggregate size distributions (e) of 1.5% Na-Mt dispersions at different added NaCl concentrations. Symbols are experimental data and lines are calculations from the complex conductivity model.

Again, the complex conductivity model describes the complex conductivity measurements very well using the aggregate size distributions presented in Fig. 8e and Fig. 9e. ASD are relatively similar when the added NaCl concentration increases up to 0.01 M NaCl. We observed less small aggregates (size inferior to one micrometer) and



more large aggregates (size superior to ten micrometers) for 0.06 M added NaCl. A very small peak in the ASD around 20  $\mu\text{m}$  and a large peak around 70-100  $\mu\text{m}$  were observed for respectively 1 and 1.5% dispersions. These peaks may be due to the coagulation of Na-Mt particles into denser and considerably larger aggregates and result from the considerable increase of the measured quadrature conductivity in the low 0.1 to 100 Hz frequency range (a “peak” around 0.5 Hz is observed for  $\sigma''$  of 1.5% dispersions) (Figs. 8b,e and 9b,e). The mean relaxation time of 1.5% Na-Mt dispersions (inferred from the DD approach) increases significantly when the added NaCl concentration reaches 0.06 M (Figs. A5 and A6). The modeled aggregates size in the 10–100  $\mu\text{m}$  range corresponds to the size of Na-Mt aggregates in compacted Kunipia-F bentonites observed by Kozaki et al. [98] using microfocus X-Ray computerized tomography (Micro-CT) (they observed a peak around 60  $\mu\text{m}$ ). Coagulation of Na-Mt particles in basic water (pH = 7.5 to 8.5) has also been observed for added NaCl or NaNO<sub>3</sub> concentrations between 0.01 and 0.1 M [12, 38].

The in-phase conductivity of Na-Mt dispersions in initially Milli-Q water and in water containing around  $10^{-4}$ ,  $5 \times 10^{-4}$ , and  $10^{-3}$  M added NaCl are not very sensitive to salinity (Figs. 8a and 9a) because of the conductivity of the diffuse layer and neutral water (due to ions released from Na-Mt). When the added NaCl concentration becomes higher than  $10^{-3}$  M, the in-phase conductivity increases quasi-linearly with the NaCl concentration because the NaCl conductivity dominates the conductivity of the diffuse layer and due to released ions (Eqs. (10) and (14)) (Figs. 8a, 9a, and A4). The NaCl conductivity controls the in-phase conductivity of 1 and 1.5% Na-Mt dispersions for lower added NaCl concentrations compared to bentonite muds because of their lower solid content [53].

The quadrature conductivity and dielectric permittivity of the dispersions are less sensitive to salinity than their in-phase conductivity and only slightly increase with salinity in the 100 Hz to 45 kHz frequency range (Figs. 8a,b,d and 9a,b,d). We explain this observation by the negative and permanent surface charge of the basal plane of Na-Mt and by the slight compression of the aggregates when salinity increases (decrease of the porosity  $\Omega_w$  of the aggregates; Table A4), which may control their polarization. The increase of the compression of the diffuse layer with salinity (observed through the decreasing Debye length, Eq. (13)) and the coagulation of Na-Mt particles for the highest salinities explain the slight decrease of the porosity of the aggregates [16, 38]. The increase of the polarization of the dispersions with salinity is observed through the increase of the normalized total chargeability, which is more pronounced for 1.5% than for 1% dispersions (Fig. A5).

The phase in the 100 Hz to 45 kHz frequency range decreases when salinity increases because the in-phase conductivity increases more rapidly with salinity than the quadrature conductivity ( $\varphi \cong \sigma''/\sigma'$ , Figs. 8c and 9c). For frequencies below 100 Hz, the decrease of the phase with salinity slows down and the phase increases when the added NaCl concentration reaches 0.06 M because of the increase of the quadrature conductivity. In addition, like for the quadrature conductivity, the relative dielectric permittivity slightly increases with salinity for frequencies above 100 Hz (Figs. 8d and 9d). Below 100 Hz and for an added NaCl concentration around 0.06 M, the relative dielectric permittivity considerably increases when frequency decreases because it depends on the ratio of the quadrature conductivity to the frequency.

#### 4.4. Effect of pH and salinity on complex conductivity

The in-phase and quadrature conductivity, phase, effective dielectric permittivity and computed aggregate size distributions of 1% Na-Mt dispersions at  $\text{pH} = 7.3 \pm 0.4$  and  $\text{pH} = 5.5 \pm 0.4$  and at different added NaCl concentrations were presented in Figs. 10 and 11. The modeled aggregate size distributions have the same behavior than those obtained at  $\text{pH} = 10.1$ , with peaks in the ASD around 15 (large peak at  $\text{pH} = 7.3$ ) and 35  $\mu\text{m}$  (small peak at  $\text{pH} = 5.5$ ). As previously observed, the in-phase conductivity is more sensitive to salinity than the quadrature conductivity and slightly increases when pH decreases from 10.1 to 7.3 and 5.5 because of the additional conductivity due to the addition of HCl (Figs. 8a, 10a and 11a).

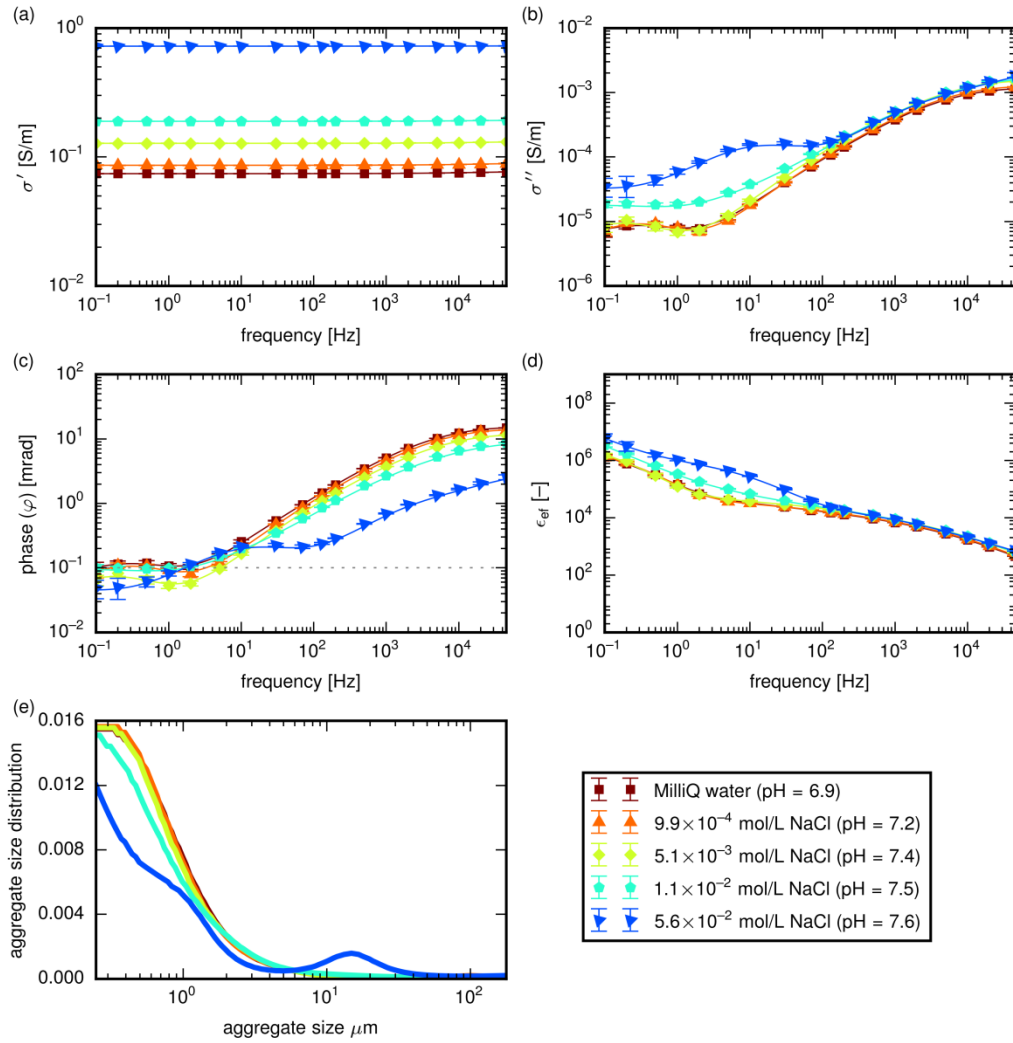

**Fig. 10.** In-phase conductivity (a), quadrature conductivity (b), phase (c), effective dielectric permittivity (d) as a function of frequency, and computed aggregate size distributions (e) of 1% Na-Mt dispersion at pH = 7.3 and at different added NaCl concentrations. Symbols are experimental data and lines are calculations from the complex conductivity model.

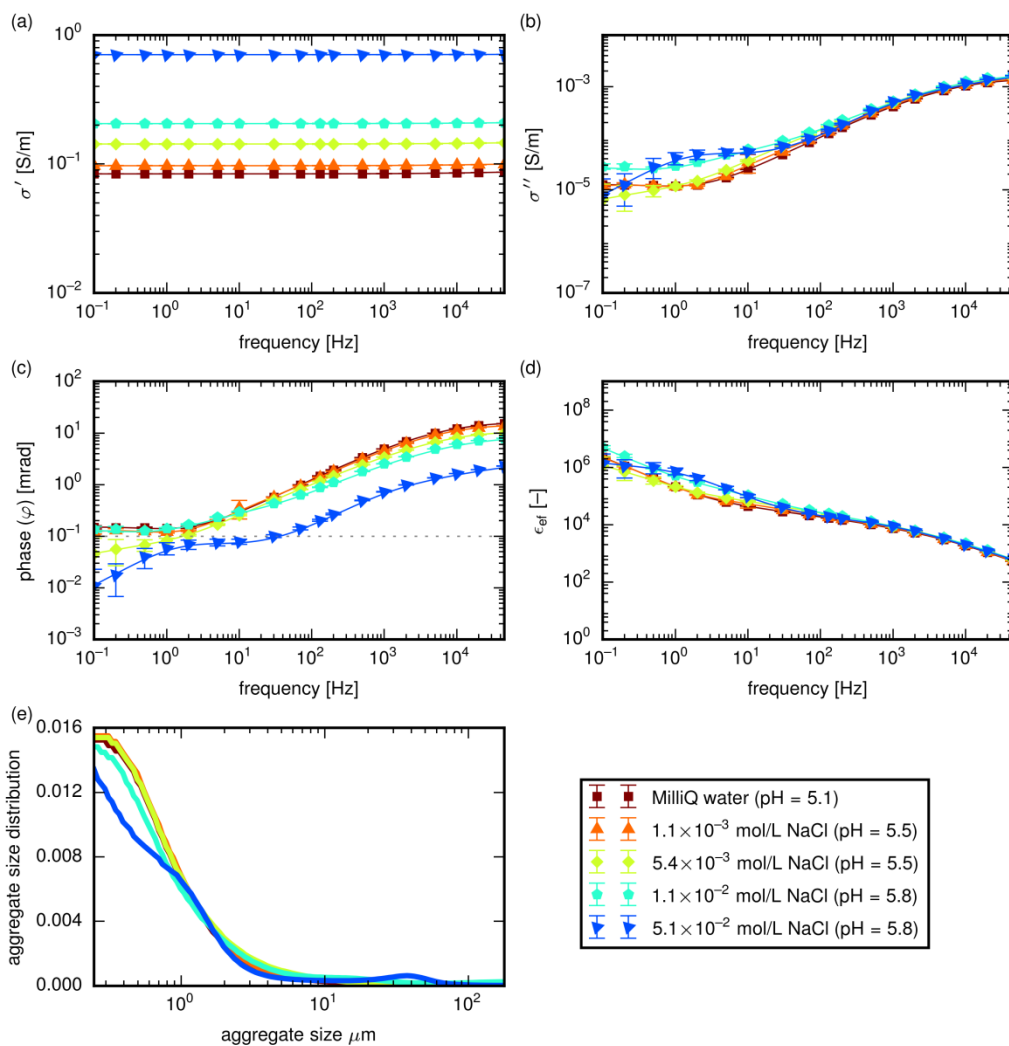

**Fig. 11.** In-phase conductivity (a), quadrature conductivity (b), phase (c), effective dielectric permittivity (d) as a function of frequency, and computed aggregate size distributions (e) of 1% Na-Mt dispersion at pH = 5.5 and at different added salinities (NaCl). Symbols are experimental data and lines are calculations from the complex conductivity model.

Furthermore, the quadrature conductivity in the 100 Hz to 45 kHz frequency range is relatively similar for all the pH because the electrochemical properties of the basal surface of Na-Mt, which are not very sensitive to pH, may control its quadrature conductivity (Figs. 8b, 10b and 11b and A7). Normalized total chargeability is also not

very sensitive to pH and increases with salinity (Fig. A8). Nevertheless, the quadrature conductivity spectra in the 0.1 to 100 Hz frequency range exhibit different behaviors depending on the pH of the dispersion (Figs. 8b, 10b and 11b). The quadrature conductivity spectra at pH = 7.3 and 5.5 are relatively similar up to an added NaCl concentration of roughly 5 mM and are significantly higher than those at pH = 10.1. When the added NaCl concentration is larger than around 5 mM NaCl, the quadrature conductivity spectra at pH = 7.3 and 5.5 increase with salinity in the frequency range 0.1–100 Hz. Some “peaks” in the quadrature conductivity spectra can be observed for frequencies around 10 Hz (huge increase of the quadrature conductivity at pH = 7.3) and 2 Hz (pH = 5.5) when added NaCl concentration is around 0.05 M. The mean relaxation time of the dispersions at pH = 7.3 and pH = 5.5 is not very sensitive to the salinity and only increases significantly at pH = 7.3 for 0.056 M added NaCl (Figs. A8 and A9).

These observations can be explained by the earlier coagulation of Na-Mt particles in neutral and acid waters [12], resulting in larger modeled aggregates than for Na-Mt dispersions at pH = 10.1 (Figs. 8e, 10e and 11e). When the pH decreases from 10.1 to 7.3 and 5.5, Na-Mt particles may not be only influenced by repulsive face-to-face electrostatic interactions, but also by attractive edge-to-edge (EE) and edge-to-face (EF) interactions [12, 22, 47]. These interactions may modify the structure of the Na-Mt aggregates and the quadrature conductivity measurements in the 0.1 to 100 Hz frequency range. When the pH is neutral, Na-Mt particles have a very low edge surface charge favoring attractive EE interactions (because of van der Waals interactions) between Na-Mt particles and hence their coagulation [12, 22, 27, 99].

## 5. Conclusions

The complex conductivity of Na-Mt dispersions was measured in the low 0.1 Hz to 45 kHz frequency range using a four-electrode system, the ZEL-SIP-04 apparatus. Different weight fractions of Na-Mt, from 0.5 to 5.2%, added NaCl concentrations, from  $10^{-4}$  to  $5 \times 10^{-2}$  mol L<sup>-1</sup>, and pH, from 5.5 to 10.2, were investigated. The measured complex conductivity spectra were inverted using the Debye decomposition approach to obtain the relaxation time and the aggregate size distributions of Na-Mt dispersions.

The complex conductivity measurements were described using a mechanistic model that considers the electrical properties of the Stern and diffuse layer at the basal surface of Na-Mt. We assume that the neutral and diffuse layer water contribute to the in-phase (real) conductivity and that the polarized Stern layer contributes to the quadrature (imaginary) conductivity of Na-Mt dispersions. The microstructural and interfacial parameters of our model were determined according to CEC, viscosity and light-transmission measurements, specific surface area estimates reported in the literature and a triple layer model of the electrochemical properties of the basal surface of Na-Mt. The concentration of ions released from the dissolution of Na-Mt in water (in the case of pH = 10) or of chloride ions due to the addition of HCl (for pH = 5.5 and pH = 7.3) were adjusted to match in-phase conductivity measurements. The porosity of the aggregates was adjusted according to quadrature conductivity measurements.

The complex conductivity measurements were successfully reproduced by our model. The modeled aggregate size distribution influences the shape and the microstructural and interfacial properties of Na-Mt the magnitude of the quadrature conductivity. The negative and permanent surface charge of the basal surface of Na-Mt may control the quadrature conductivity (or the dielectric permittivity) of the dispersions. We assume

that 60% of the counter-charge in the EDL is located in the Stern layer and that the mobility of the  $\text{Na}^+$  counter-ions in the Stern layer is half its value in bulk water, according to the results of recent molecular dynamics simulations. We also consider very porous aggregates (porosity  $\geq 98\%$ ) of sizes ranging from hundreds of nanometers to tens of micrometers.

The quasi-linear increase of the in-phase and quadrature conductivity when the weight fraction of Na-Mt increases was reproduced by considering the increase of the external surface area and the volumetric excess of charge of the aggregates. The 1 and 1.5% Na-Mt dispersions also exhibit a very low surface conductivity due to their low solid content (solid volume  $< 2\%$ ). In the 100 Hz to 45 kHz frequency range, their quadrature conductivity only slightly increases with salinity and is not sensitive to pH because it may be controlled by the surface charge of the basal surface. We explain the slight increase of the quadrature conductivity by assuming a slight decrease of the porosity and a resulting increase of the volumetric excess of charge of the aggregates. In the 0.1 to 100 Hz frequency range, the quadrature conductivity increases sharply when the added NaCl concentration is between 0.01 and 0.1 mol L<sup>-1</sup> because of the possible coagulation of Na-Mt particles into larger and less porous aggregates. This phenomenon is enhanced when the weight fraction of Na-Mt increases (from 1 to 1.5%), at pH = 7.3 and in a lesser extent at pH = 5.5 because of less repulsion between Na-Mt particles.

Our work improves the understanding of the physico-chemical mechanisms controlling the conduction and polarization of Na-Mt dispersions and their electrochemical behavior. For future work, it would be very interesting to carry out aggregate size distributions measurements using different methods such as transmission electron microscopy, centrifugal sedimentation, dynamic light scattering, and coulter-counter



measurements. It would also be very interesting to consider the full polarization of the diffuse layer to model our complex conductivity measurements.

### **Acknowledgments**

This study was carried out within the framework of the Zetaclay and Condclay projects funded by the MIPOR program of Défi CNRS NEEDS MIPOR. The research mobility grant of P. Leroy at the Department of Earth Sciences of Uppsala University was funded by l'Institut Carnot BRGM. P. Leroy warmly thanks H. Gailhanou, M. Bizi, and S. Gaboreau for providing the Kunipia-F montmorillonite and performing filtration and lixiviation experiments. P. Leroy also thanks warmly André Revil for fruitful discussions. The authors thank the Editor and the three anonymous Reviewers for their constructing review of our paper.

## Appendix A. Maxwell-Wagner polarization and volume fractions of the neutral and diffuse layer water

The relaxation frequency of the Maxwell-Wagner polarization of dispersions is given by [44, 100]:

$$f_{\text{MW}} \approx \frac{D_w}{\pi\chi_d^2}, \quad (\text{A1})$$

where  $\chi_d$  is the Debye length and  $D_w$  is the mean diffusion coefficient of the ions in neutral water.

Eq. (A1) gives  $f_{\text{MW}} \geq 70$  kHz for a NaCl electrolyte at a temperature of 298 K ( $D_w \cong 2 \times 10^{-9} \text{ m}^2 \text{ s}^{-1}$  and  $\chi_d \cong 96$  nm for an ionic strength of  $10^{-5}$  M, Eq. (13)), which is beyond the highest frequency of our complex conductivity measurements (45 kHz). Therefore, M-W polarization can be neglected in our complex conductivity modeling.

In addition, the volume fractions of the neutral and diffuse layer water in the dispersion are defined by:

$$\Omega_n^w = V_n^w / V_t, \quad (\text{A2})$$

$$\Omega_d^w = V_d^w / V_t, \quad (\text{A3})$$

where  $V_n^w$ ,  $V_d^w$ , and  $V_t$  are the volumes (in  $\text{m}^3$ ) of the neutral and diffuse layer water and the total volume of the dispersion, respectively. The volume of the diffuse layer is given by:

$$V_d^w = \delta_s S S_o 2\chi_d. \quad (\text{A4})$$

The volume of the neutral water was calculated according to:

$$V_n^w = V_t - V_s - V_d^w, \quad (\text{A5})$$

$$V_s = \frac{\delta_s}{10^3 \rho_s}, \quad (\text{A6})$$

and, by combining Eqs. (A4), (A5) and (A6), we obtained:

$$V_n^w = V_t - \delta_s \left( \frac{1}{10^3 \rho_s} + SS_o 2\chi_d \right). \quad (\text{A7})$$

Finally, by combining Eqs. (A2), (A3), (A4) and (A7), we obtained:

$$\Omega_n^w = 1 - \frac{\delta_s}{V_t} \left( \frac{1}{10^3 \rho_s} + SS_o 2\chi_d \right), \quad (\text{A8})$$

$$\Omega_d^w = \frac{\delta_s}{V_t} SS_o 2\chi_d. \quad (\text{A9})$$

### Appendix B. Ion concentrations in neutral water

The ion concentrations in neutral water,  $C_i^w$ , were calculated according to:

$$C_{\text{Cl}^-}^w = C_{\text{NaCl}}^w + C_{\text{Cl}^-}^w, \quad (\text{B1})$$

$$C_{\text{H}^+}^w \cong a_{\text{H}^+}^w = 10^{-\text{pH}}, \quad (\text{B2})$$

$$C_{\text{OH}^-}^w \cong K_w / C_{\text{H}^+}^w, \quad (\text{B3})$$

$$C_{\text{Na}^+}^w = C_{\text{Cl}^-}^w + C_{\text{OH}^-}^w + C_{id}^w - C_{\text{H}^+}^w, \quad (\text{B4})$$

where  $C_{\text{NaCl}}^w$  is the concentration of added NaCl,  $C_{\text{Cl}^-}^w$  is the  $\text{Cl}^-$  concentration in neutral water from HCl electrolyte,  $K_w$  is the dissociation constant of water molecules ( $K_w \cong 10^{-14}$  at a pressure of one bar and a temperature of 298 K [59, 65]) and  $C_{id}^w$  is the concentration of ions released from the dissolution of Na-Mt such as  $\text{H}_3\text{SiO}_4^-$ ,  $\text{SO}_4^{2-}$  or  $\text{Mg}^{2+}$  ions (at basic  $\text{pH} \geq 10$ ) [88, 95, 101].

### Appendix C. Excess of charge, porosity, and average potential of the dispersion

The excess of charge per water volume,  $Q_v$ , can be expressed as a function of the surface charge density of Mt,  $Q_0$ . These two parameters are related to each other by the overall electroneutrality condition for the dispersion, which implies:

$$\frac{1}{V_t} \left( \int_0^{V_w} Q_v dV + \int_0^{S_w} Q_0 dS \right) = 0, \quad (C1)$$

where  $dV$ ,  $V_w$ , and  $dS$ ,  $S_w$ , are the infinitesimal and total volume of water and infinitesimal and total external surface area (excluding the surface area of the interlayer space) of the clay, respectively.

If  $Q_v$  and  $Q_0$  are constant, Eq. (C1) simplifies to:

$$Q_v = -\frac{S_w}{V_w} Q_0. \quad (C2)$$

The parameter  $S_w$  is given by:

$$S_w = \delta_s SS_o, \quad (C3)$$

$$S_w = \rho_s V_s 10^3 SS_o, \quad (C4)$$

$$S_w = \rho_s (1 - \Omega_w) V_t 10^3 SS_o. \quad (C5)$$

The water volume is:

$$V_w = \Omega_w V_t. \quad (C6)$$

By replacing  $S_w$  and  $V_w$  in Eq. (C2) by their expressions in Eqs. (C5) and (C6), we finally obtained:

$$Q_V = -\rho_s \left( \frac{1 - \Omega_w}{\Omega_w} \right) 10^3 SS_o Q_0. \quad (C7)$$

The relative volume of water in the dispersion was calculated as a function of its weight fraction,  $w_D$ , using:

$$\Omega_w = 1 - \frac{V_s}{V_t}, \quad (C8)$$

$$V_s = \frac{w_D \rho_w V_w}{\rho_s (1 - w_D)}, \quad (C9)$$

$$V_t = V_s + V_w. \quad (C10)$$

By combining Eqs. (C8)–(C10), we obtained:

$$\Omega_w = \frac{\rho_s (1 - w_D)}{w_D \rho_w + \rho_s (1 - w_D)}. \quad (C11)$$

The average electrical potential in the diffuse layer of the dispersion,  $\varphi_m$ , was calculated according to the volumetric excess of charge of the EDL,  $Q_V^e$ , given by:

$$\frac{1}{V_t} \left( \int_0^{V_d^w} Q_V^e dV + \int_0^{S_w} Q_0 dS \right) = 0. \quad (C12)$$

If  $Q_V^e$  and  $Q_0$  are constant, Eq. (C12) simplifies to:

$$Q_V^e = -\frac{S_w}{V_d^w} Q_0. \quad (C13)$$

The volume of the diffuse layer in the dispersion,  $V_d^w$ , is:

$$V_d^w = S_w 2\chi_d. \quad (\text{C14})$$

By replacing  $V_d^w$  in Eq. (C13) by its expression in Eq. (C14), we obtained:

$$Q_V^e = -\frac{Q_0}{2\chi_d}. \quad (\text{C15})$$

The volumetric excess of charge of the diffuse layer is defined by:

$$Q_V^d = 1000 N_A \sum_{i=1}^N q_i C_i^d, \quad (\text{C16})$$

$$Q_V^d = (1 - f_Q) Q_V^e. \quad (\text{C17})$$

According to Eqs. (C15)–(C17), the potential  $\varphi_m$  was calculated by solving [15, 53]:

$$1000 N_A \sum_{i=1}^N q_i C_i^w \exp\left(-\frac{q_i \varphi_m}{k_B T}\right) + (1 - f_Q) \frac{Q_0}{2\chi_d} = 0, \quad (\text{C18})$$

where  $C_i^d = C_i^w \exp(-q_i \varphi_m / k_B T)$ .

If the compression of the aggregates is considered, Eq. (C18) becomes according to

Eqs. (A3), (C5), (C7), (C13), and (C16)–(C17):

$$1000 N_A \sum_{i=1}^N q_i C_i^w \exp\left(-\frac{q_i \varphi_m}{k_B T}\right) + (1 - f_Q) \frac{\Omega_w}{\Omega_d} Q_V = 0. \quad (\text{C19})$$

### Appendix D. Surface conductivity of a Na-Mt aggregate

We used the Schwarz's theory [70] to calculate the surface conductivity of a Na-Mt aggregate of effective diameter  $d_k$  [70]:

$$\sigma_s(\omega) = \frac{4}{d_k} \Sigma_S \frac{i\omega\tau_k}{1+i\omega\tau_k}, \quad (\text{D1})$$

where  $\Sigma_S$  is the specific surface conductivity of the Stern layer (in S) [69, 75],

$$\Sigma_S = \beta_S |Q_\beta|. \quad (\text{D2})$$

By combining Eqs. (D1) and (D2), and considering a negative surface charge  $Q_0$  implying a positive value of  $Q_\beta$ , we obtained:

$$\sigma_s = \frac{4}{d_k} \beta_S Q_\beta \frac{i\omega\tau_k}{1+i\omega\tau_k}. \quad (\text{D3})$$

Eq. (D3) cannot be directly used to describe the magnitude of the surface conductivity of a Na-Mt aggregate because its surface area is considerably higher than the surface area of a non-porous sphere. For that reason, we modified Eq. (D3) by considering the surface area ratio between the surface area of a spherical Na-Mt aggregate,  $S_w$ , and the surface area of a non-porous sphere with the same effective diameter  $d_k$ ,  $S_k$ . This implies:

$$\sigma_s = \frac{4}{d_k} \beta_S Q_\beta \frac{S_w}{S_k} \frac{i\omega\tau_k}{1+i\omega\tau_k}. \quad (\text{D4})$$



For a non-porous aggregate,  $S_w/S_k = 1$ , and Eq. (D4) becomes Eq. (D3). By replacing in Eq. (D4) the parameter  $S_w$  by its expression in Eq. (C5) ( $S_w = \rho_s(1 - \Omega_w)V_t 10^3 SS_o$ ) with  $V_t = \pi d_k^3/6$ , and the parameter  $S_k$  by  $S_k = \pi d_k^2$ , we obtained:

$$\sigma_s = \frac{2}{3} \beta_s Q_\beta \rho_s (1 - \Omega_w) 10^3 SS_o \frac{i\omega\tau_k}{1 + i\omega\tau_k}. \quad (\text{D5})$$

Eq. (D5) was simplified by introducing the volumetric excess of charge of the aggregate,  $Q_V = -\rho_s[(1 - \Omega_w)/\Omega_w]10^3 SS_o Q_0$  (Eq. (C7)). This implies:

$$\sigma_s = -\frac{2}{3} \Omega_w \beta_s \frac{Q_\beta}{Q_0} Q_V \frac{i\omega\tau_k}{1 + i\omega\tau_k}. \quad (\text{D6})$$

By introducing in Eq. (D6) the fraction of the counter-charge in the Stern layer,  $f_Q = -Q_\beta/Q_0$  (Eq. (8)), we finally found for the surface conductivity of the aggregate:

$$\sigma_s = \frac{2}{3} \Omega_w \beta_s f_Q Q_V \frac{i\omega\tau_k}{1 + i\omega\tau_k}. \quad (\text{D7})$$

The surface conductivity of aggregates of different sizes was computed by convoluting the aggregate size distribution by the surface conductivity of the aggregate (superposition principle) [58, 72, 102]. We obtained:

$$\sigma_s = f(d) \otimes \sigma_s(d), \quad (\text{D8})$$

$$\sigma_s = \sum_{k=1}^L f(d_k) \frac{2}{3} \Omega_w \beta_s f_Q Q_V \frac{i\omega\tau_k}{1 + i\omega\tau_k}, \quad (\text{D9})$$

$$\sigma_s = \frac{2}{3} \Omega_w \beta_s f_Q Q_V \sum_{k=1}^L f(d_k) \frac{i\omega\tau_k}{1 + i\omega\tau_k}, \quad (\text{D10})$$

where  $f(d_k)$  is the discretized aggregate size distribution.

ACCEPTED MANUSCRIPT

## References

- [1] R.M. Garrels, F.T. Mackenzie, *Evolution of sedimentary rocks*, New York, 1971.
- [2] L. Cary, H. Pauwels, P. Ollivier, G. Picot, P. Leroy, B. Mougin, G. Braibant, J. Labille, Evidence for TiO<sub>2</sub> nanoparticle transfer in a hard-rock aquifer, *J Contam Hydrol* 179 (2015) 148-159.
- [3] P. Leroy, A. Revil, A triple-layer model of the surface electrochemical properties of clay minerals, *Journal of Colloid and Interface Science* (2004) 371-380.
- [4] D. Guisseau, P.P. Mas, D. Beaufort, J.P. Girard, A. Inoue, B. Sanjuan, S. Petit, A. Lens, A. Genter, Significance of the depth-related transition montmorillonite-beidellite in the Bouillante geothermal field (Guadeloupe, Lesser Antilles), *Am Mineral* 92(11-12) (2007) 1800-1813.
- [5] B. Rotenberg, V. Marry, J.F. Dufreche, N. Malikova, E. Giffaut, P. Turq, Modelling water and ion diffusion in clays: A multiscale approach, *Cr Chim* 10(10-11) (2007) 1108-1116.
- [6] M. Heuser, G. Spagnoli, P. Leroy, N. Klitzsch, H. Stanjek, Electro-osmotic flow in clays and its potential for reducing clogging in mechanical tunnel driving, *B Eng Geol Environ* 71(4) (2012) 721-733.
- [7] M. Nouveau, G. Grandjean, P. Leroy, M. Philippe, E. Hedri, H. Boukcim, Electrical and thermal behavior of unsaturated soils: experimental results, *J Appl Geophys* 128 (2016) 115-122.
- [8] R.E. Grim, *Applied Clay Mineralogy*, McGraw-Hill, New York, 1962.
- [9] M. Brigatti, E. Galán, B. Theng, Chapter 2 - Structure and Mineralogy of Clay Minerals in: F.L. Bergaya, G. (Ed.), *Handbook of Clay Science*, Elsevier, Oxford, 2013, pp. 21-81.
- [10] C. Tournassat, M. Bizi, G. Braibant, C. Crouzet, Influence of montmorillonite tactoid size on Na-Ca cation exchange reactions, *Journal of Colloid and Interface Science* 364(2) (2011) 443-454.
- [11] M.B. McBride, P. Baveye, Diffuse double-layer models, long-range forces, and ordering in clay colloids, *Soil Sci Soc Am J* 66(4) (2002) 1207-1217.
- [12] E. Tombacz, M. Szekeres, Colloidal behavior of aqueous montmorillonite suspensions: the specific role of pH in the presence of indifferent electrolytes, *Appl Clay Sci* 27(1-2) (2004) 75-94.
- [13] I.C. Bourg, G. Sposito, A.C.M. Bourg, Modeling the acid-base surface chemistry of montmorillonite, *Journal of Colloid and Interface Science* 312(2) (2007) 297-310.
- [14] C. Tournassat, C.A.J. Appelo, Modelling approaches for anion-exclusion in compacted Nantertonite, *Geochimica Et Cosmochimica Acta* 75(13) (2011) 3698-3710.
- [15] P. Leroy, A. Revil, S. Altmann, C. Tournassat, Modeling the composition of the pore water in a clay-rock geological formation (Callovo-Oxfordian, France), *Geochimica Et Cosmochimica Acta* 71(5) (2007) 1087-1097.
- [16] P. Leroy, C. Tournassat, O. Bernard, N. Devau, M. Azaroual, The electrophoretic mobility of montmorillonite. Zeta potential and surface conductivity effects, *Journal of Colloid and Interface Science* 451 (2015) 21-39.
- [17] C. Tournassat, Y. Chapron, P. Leroy, M. Bizi, F. Boulahya, Comparison of molecular dynamics simulations with triple layer and modified Gouy-Chapman models in a 0.1 M NaCl-montmorillonite system, *Journal of Colloid and Interface Science* 339(2) (2009) 533-541.
- [18] I.C. Bourg, G. Sposito, Molecular dynamics simulations of the electrical double layer on smectite surfaces contacting concentrated mixed electrolyte (NaCl-CaCl<sub>2</sub>) solutions, *Journal of Colloid and Interface Science* 360(2) (2011) 701-715.
- [19] C. Tournassat, J.A. Davis, C. Chiaberge, S. Grangeon, I.C. Bourg, Modeling the Acid-Base Properties of Montmorillonite Edge Surfaces, *Environ Sci Technol* 50 (2016) 13436-13445.
- [20] M.-Y. Wu, Y. Adachi, Effects of electrolyte concentration and pH on the sedimentation rate of coagulated suspension of sodium montmorillonite, *Colloids and Surfaces A: Physicochemical and Engineering Aspects* 506 (2016) 686-693.
- [21] J. Labille, C. Harns, J.-Y. Bottero, J. Brant, Heteroaggregation of Titanium Dioxide Nanoparticles with Natural Clay Colloids, *Environ Sci Technol* 49(11) (2015) 6608-6616.
- [22] F.J. Arroyo, F. Carrique, M.L. Jimenez-Olivares, A.V. Delgado, Rheological and electrokinetic properties of sodium montmorillonite suspensions - II. Low-frequency dielectric dispersion, *Journal of Colloid and Interface Science* 229(1) (2000) 118-122.
- [23] C. Grosse, A.V. Delgado, Dielectric dispersion in aqueous colloidal systems, *Curr Opin Colloid In* 15(3) (2010) 145-159.
- [24] N.C. Lockhart, Electrical-Properties and the Surface Characteristics and Structure of Clays .1. Swelling Clays, *Journal of Colloid and Interface Science* 74(2) (1980) 509-519.

- [25] R. Raythatha, P.N. Sen, Dielectric-Properties of Clay Suspensions in Mhz to Ghz Range, *Journal of Colloid and Interface Science* 109(2) (1986) 301-309.
- [26] M. Rasmusson, W. Rowlands, R.W. OBrien, R.J. Hunter, The dynamic mobility and dielectric response of sodium bentonite, *Journal of Colloid and Interface Science* 189(1) (1997) 92-100.
- [27] A. Delgado, F. Gonzalezcaballero, J.M. Bruque, On the Zeta-Potential and Surface-Charge Density of Montmorillonite in Aqueous-Electrolyte Solutions, *Journal of Colloid and Interface Science* 113(1) (1986) 203-211.
- [28] G. Roy, M. Pelletier, F. Thomas, C. Despas, J. Bessiere, Aggregation in Na-, K- and Ca-montmorillonite dispersions, characterized by impedance spectroscopy, *Clay Miner* 35(2) (2000) 335-343.
- [29] L.M. Dudley, S. Bialkowski, D. Or, C. Junkermeier, Low frequency impedance behavior of montmorillonite suspensions: Polarization mechanisms in the low frequency domain, *Soil Sci Soc Am J* 67(2) (2003) 518-526.
- [30] M. Jiménez, A. Delgado, U. Kaatze, Surface characterization of clay particles via dielectric spectroscopy, *Annales UMCS, Chemistry* 63(-1) (2008).
- [31] Y. Tsujimoto, C. Chassagne, Y. Adachi, Dielectric and electrophoretic response of montmorillonite particles as function of ionic strength, *Journal of Colloid and Interface Science* 404 (2013) 72-79.
- [32] Y. Tsujimoto, C. Chassagne, Y. Adachi, Comparison between the electrokinetic properties of kaolinite and montmorillonite suspensions at different volume fractions, *Journal of Colloid and Interface Science* 407 (2013) 109-115.
- [33] M.C. Tirado, F.J. Arroyo, A.V. Delgado, C. Grosse, Measurement of the low-frequency dielectric properties of colloidal suspensions: Comparison between different methods, *Journal of Colloid and Interface Science* 227(1) (2000) 141-146.
- [34] L.S. Collet, History of induced polarization method, in: J.B. Fink, McAlister, E. O., Sternberg, B. K., Widuwilt, W. G. and Ward, S. H. (Ed.), *Induced polarization: Applications and Case Histories*, Society of Exploration Geophysics, Tulsa, Oklahoma, 1990.
- [35] A. Weller, F.D. Borner, Measurements of spectral induced polarization for environmental purposes, *Environ Geol* 27(4) (1996) 329-334.
- [36] Y. Luo, G. Zhang, Theory and application of spectral induced polarization, *Society of Exploration Geophysicists Tulsa*, 1998.
- [37] E. Zimmermann, A. Kemna, J. Berwix, W. Glaas, H.M. Munch, J.A. Huisman, A high-accuracy impedance spectrometer for measuring sediments with low polarizability, *Meas Sci Technol* 19(10) (2008).
- [38] L.J. Michot, I. Bihannic, F. Thomas, B.S. Lartiges, Y. Waldvogel, C. Caillet, J. Thieme, S.S. Funari, P. Levitz, Coagulation of Na-Montmorillonite by Inorganic Cations at Neutral pH. A Combined Transmission X-ray Microscopy, Small Angle and Wide Angle X-ray Scattering Study, *Langmuir* 29(10) (2013) 3500-3510.
- [39] C. Tournassat, A. Neaman, F. Villieras, D. Bosbach, L. Charlet, Nanomorphology of montmorillonite particles: Estimation of the clay edge sorption site density by low-pressure gas adsorption and AFM observations, *Am Mineral* 88(11-12) (2003) 1989-1995.
- [40] L. Le Forestier, F. Muller, F. Villieras, M. Pelletier, Textural and hydration properties of a synthetic montmorillonite compared with a natural Na-exchanged clay analogue, *Appl Clay Sci* 48 (2010) 18-25.
- [41] L.L. Schramm, J.C.T. Kwak, Influence of Exchangeable Cation Composition on the Size and Shape of Montmorillonite Particles in Dilute Suspension, *Clay Clay Miner* 30(1) (1982) 40-48.
- [42] G. Sposito, K.M. Holtzclaw, C. Jouany, L. Charlet, Cation Selectivity in Sodium - Calcium, Sodium - Magnesium, and Calcium - Magnesium Exchange on Wyoming Bentonite at 298-K, *Soil Sci Soc Am J* 47(5) (1983) 917-921.
- [43] J. Lyklema, *Fundamentals of Interface and Colloid Science. Volume II: Solid-Liquid Interfaces* Academic Press, London, 1995.
- [44] A.V. Delgado, F. Gonzalez-Caballero, R.J. Hunter, L.K. Koopal, J. Lyklema, Measurement and interpretation of electrokinetic phenomena, *Journal of Colloid and Interface Science* 309(2) (2007) 194-224.
- [45] R.J. Hunter, *Zeta Potential in Colloid Science: Principles and Applications*, Academic Press, New York, 1981.
- [46] D.L. Chapman, A contribution to the theory of electrocapillarity *Philosophical Magazine Serie 6* 25(148) (1913) 475-481.

- [47] G. Lagaly, S. Ziesmer, Colloid chemistry of clay minerals: the coagulation of montmorillonite dispersions, *Advances in Colloid and Interface Science* 100 (2003) 105-128.
- [48] J.D.G. Duran, M.M. Ramos-Tejada, F.J. Arroyo, F. Gonzalez-Caballero, Rheological and electrokinetic properties of sodium montmorillonite suspensions - I. Rheological properties and interparticle energy of interaction, *Journal of Colloid and Interface Science* 229(1) (2000) 107-117.
- [49] K. Norrish, The swelling of montmorillonite, *Discussions of the Faraday Society* 18 (1954) 120-134.
- [50] E. Ferrage, C. Tournassat, E. Rinnert, B. Lanson, Influence of pH on the interlayer cationic composition and hydration state of Ca-montmorillonite: Analytical chemistry, chemical modelling and XRD profile modelling study, *Geochimica Et Cosmochimica Acta* 69(11) (2005) 2797-2812.
- [51] P. Leroy, A. Revil, A mechanistic model for the spectral induced polarization of clay materials, *J Geophys Res-Sol Ea* 114(B10202) (2009) 1-21.
- [52] A. Revil, Spectral induced polarization of shaly sands: Influence of the electrical double layer, *Water Resources Research* 48(W02517) (2012) 1-23.
- [53] G. Okay, P. Leroy, A. Ghorbani, P. Cosenza, C. Camerlynck, J. Cabrera, N. Florsch, A. Revil, Spectral induced polarization of clay-sand mixtures: Experiments and modeling, *Geophysics* 79(6) (2014) E353-E375.
- [54] A. Revil, J.D. Eppehimer, M. Skold, M. Karaoulis, L. Godinez, M. Prasad, Low-frequency complex conductivity of sandy and clayey materials, *Journal of Colloid and Interface Science* 398 (2013) 193-209.
- [55] A. Revil, M. Skold, S.S.H.Y. Wu, Y.X. Wu, D.B. Watson, M. Karaoulis, Petrophysical properties of saprolites from the Oak Ridge Integrated Field Research Challenge site, Tennessee, *Geophysics* 78(1) (2013) D21-D40.
- [56] M.H. Waxman, L.J.M. Smits, Electrical conductivities in oil bearing shaly sands, *Society of Petroleum Engineers Journal* 8 (1968) 107-122.
- [57] H.J. Vinegar, M.H. Waxman, Induced Polarization of Shaly Sands, *Geophysics* 49(8) (1984) 1267-1287.
- [58] P. Leroy, A. Revil, A. Kemna, P. Cosenza, A. Ghorbani, Complex conductivity of water-saturated packs of glass beads, *Journal of Colloid and Interface Science* 321(1) (2008) 103-117.
- [59] D.R. Lide, *CRC Handbook of Chemistry and Physics* CRC Press, Boca Raton, 1990.
- [60] A. Revil, Thermal conductivity of unconsolidated sediments with geophysical applications, *J Geophys Res-Sol Ea* 105(B7) (2000) 16749-16768.
- [61] C. Clavier, G. Coates, J. Dumanoir, Theoretical and experimental bases for the dual-water model for interpretation of shaly sands, *Society of Petroleum Engineers Journal* 4 (1984) 153-168.
- [62] A. Revil, On charge accumulation in heterogeneous porous rocks under the influence of an external electric field, *Geophysics* 78(4) (2013) D271-D291.
- [63] P. Debye, E. Hückel, The theory of electrolytes. I. Lowering of freezing point and related phenomena, *Physikalische Zeitschrift* 24 (1923) 185-206.
- [64] A. Revil, L.M. Cathles, S. Losh, J.A. Nunn, Electrical conductivity in shaly sands with geophysical applications, *J Geophys Res-Sol Ea* 103(B10) (1998) 23925-23936.
- [65] D.L. Parkhurst, C.A.J. Appelo, Description of Input and Examples for PHREEQC Version 3-a Computer Program for Speciation, Batch-reaction, One-dimensional Transport, and Inverse Geochemical Calculations, in: U.S.G.S. Reston (Ed.), *U.S. Geological Survey Techniques and Methods, Book 6, Modeling Techniques*, Denver, 2013, p. 497.
- [66] P.W. Atkins, J. de Paula, *Atkin's physical chemistry* 8th Edition, Oxford University Press, Oxford, United Kingdom, 2006.
- [67] J.J. Bikerman, Electrokinetic equations and surface conductance. A survey of the diffuse double layer theory of colloidal solutions *Transactions of the Faraday Society* 35 (1940) 154-160.
- [68] A. Revil, P.W.J. Glover, Theory of ionic-surface electrical conduction in porous media, *Phys Rev B* 55(3) (1997) 1757-1773.
- [69] J. Lyklema, S.S. Dukhin, V.N. Shilov, The relaxation of the double-layer around colloidal particles and the low-frequency dielectric-dispersion. Part I. Theoretical Considerations, *J Electroanal Chem* 143(1-2) (1983) 1-21.
- [70] G. Schwarz, A theory of the low-frequency dielectric dispersion of colloidal particles in electrolyte solution *The Journal of Physical Chemistry* 66 (1962) 2636-2642.



- [71] E.H.B. DeLacey, L.R. White, Dielectric response and conductivity of dilute suspensions of colloidal particles, *Journal of the Chemical Society, Faraday Transactions 2* 77(11) (1981) 2007.
- [72] D.P. Lesmes, F.D. Morgan, Dielectric spectroscopy of sedimentary rocks, *J Geophys Res-Sol Ea* 106(B7) (2001) 13329-13346.
- [73] G.R. Olhoeft, Electrical properties of rocks, in: W.R.J. Y. S. Touloukian, and R. F. Roy (Ed.), *Physical properties of rocks and minerals*, McGraw-Hill, New York, 1981, pp. 257–339.
- [74] D.A. Robinson, Measurement of the solid dielectric permittivity of clay minerals and granular samples using a time domain reflectometry immersion method, *Vadose Zone J* 3(2) (2004) 705-713.
- [75] P. Leroy, S. Li, D. Jougnot, A. Revil, Y. Wu, Modeling the evolution of complex conductivity during calcite precipitation on glass beads, *Geophys J Int* (2017) 1-18.
- [76] M. Weigand, A. Kemna, Relationship between Cole-Cole model parameters and spectral decomposition parameters derived from SIP data, *Geophys J Int* 205(3) (2016) 1414-1419.
- [77] M. Weigand, A. Kemna, Debye decomposition of time-lapse spectral induced polarisation data, *Comput Geosci-Uk* 86 (2016) 34-45.
- [78] S. Nordsiek, A. Weller, A new approach to fitting induced-polarization spectra, *Geophysics* 73(6) (2008) F235–F245.
- [79] A. Weller, S. Nordsiek, W. Debschutz, Estimating permeability of sandstone samples by nuclear magnetic resonance and spectral-induced polarization, *Geophysics* 75(6) (2010) E215-E226.
- [80] K.S. Cole, R.H. Cole, Dispersion and absorption in dielectrics. I. Alternating current characteristics, *The Journal of Chemical Physics* 9 (1941) 341-351.
- [81] A. Tarasov, K. Titov, On the use of the Cole-Cole equations in spectral induced polarization, *Geophys J Int* 195(1) (2013) 352-356.
- [82] H. Sato, T. Ashida, Y. Kohara, M. Yui, N. Sasaki, Effect of Dry Density on Diffusion of Some Radionuclides in Compacted Sodium Bentonite, *J Nucl Sci Technol* 29(9) (1992) 873-882.
- [83] M. Ochs, B. Lothenbach, H. Wanner, H. Sato, M. Yui, An integrated sorption-diffusion model for the calculation of consistent distribution and diffusion coefficients in compacted bentonite, *J Contam Hydrol* 47(2-4) (2001) 283-296.
- [84] B.K.G. Theng, S. Hayashi, M. Soma, H. Seyama, Nuclear magnetic resonance and X-ray photoelectron spectroscopic investigation of lithium migration in montmorillonite, *Clay Clay Miner* 45(5) (1997) 718-723.
- [85] L. Massat, O. Cuisinier, I. Bihannic, F. Claret, M. Pelletier, F. Masrouri, S. Gaboreau, Swelling pressure development and inter-aggregate porosity evolution upon hydration of a compacted swelling clay, *Appl Clay Sci* 124-125 (2016) 197-210.
- [86] C.M. Earnest, Thermal analysis of selected illite and smectite clay minerals. Part I. Illite clay specimens, 38 (1991) 270-286.
- [87] C. Tournassat, E. Ferrage, C. Poinssignon, L. Charlet, The titration of clay minerals II. Structure-based model and implications for clay reactivity, *Journal of Colloid and Interface Science* 273(1) (2004) 234-246.
- [88] I. Sondi, V. Tomasic, N. Filipovic-Vincekovic, Release of Silicon and Aluminum from Montmorillonite Surfaces in Aqueous Systems, *Croat Chem Acta* 81(4) (2008) 623-629.
- [89] D. Jougnot, A. Ghorbani, A. Revil, P. Leroy, P. Cosenza, Spectral induced polarization of partially saturated clay-rocks: a mechanistic approach, *Geophys J Int* 180(1) (2010) 210-224.
- [90] W.H. Pelton, W.R. Sill, B.D. Smith, Interpretation of complex resistivity and dielectric data. Part I, *Geophys Trans* 29(4) (1983) 297-330.
- [91] O.A.L. de Lima, M.M. Sharma, A generalized Maxwell-Wagner theory for membrane polarization in shaly sands, *Geophysics* 57(3) (1992) 431-440.
- [92] E. Zimmermann, *Phasengenaue Impedanzspektroskopie und -tomographie für geophysikalische Anwendungen*, Faculty of Mathematics and Natural Sciences, Rheinische Friedrich-Wilhelms-Universität Bonn, Bonn, Germany, 2010, p. 151.
- [93] E. Zimmermann, J.A. Huisman, B. Wolters, S. van Waasen, Optimal electrode design for improved phase accuracy of spectral EIT images, 6th International Symposium on Process Tomography, Cape Town, 2012, pp. 1-10.
- [94] J.A. Huisman, E. Zimmermann, O. Esser, F.-H. Haegel, A. Treichel, H. Vereecken, Evaluation of a novel correction procedure to remove electrode impedance effects from broadband SIP measurements, *J Appl Geophys* 135 (2016) 466-473.
- [95] J.S. Chen, J.H. Cushman, P.F. Low, Rheological Behavior of Na-Montmorillonite Suspensions at Low Electrolyte Concentration, *Clay Clay Miner* 38(1) (1990) 57-62.

- [96] K. Kim, J.H. Kim, I.J. Chung, Effect of the clay size on the dispersion morphology and emulsion stability of ABS/layered silicate nanocomposites, *J Appl Polym Sci* 119(3) (2011) 1287-1296.
- [97] A.V. Delgado, F.J. Arroyo, F. Gonzalez-Caballero, V.N. Shilov, Y.B. Borkovskaya, The effect of the concentration of dispersed particles on the mechanisms of low-frequency dielectric dispersion (LFDD) in colloidal suspensions, *Colloids and Surfaces a-Physicochemical and Engineering Aspects* 140(1-3) (1998) 139-149.
- [98] T. Kozaki, S. Suzuki, N. Kozai, S. Sato, H. Ohashi, Observation of microstructures of compacted bentonite by microfocus X-ray computerized tomography (micro-CT), *J Nucl Sci Technol* 38(8) (2001) 697-699.
- [99] I. Sondi, J. Biscan, V. Pravdic, Electrokinetics of pure clay minerals revisited, *Journal of Colloid and Interface Science* 178(2) (1996) 514-522.
- [100] V.N. Shilov, A.V. Delgado, F. Gonzalez-Caballero, C. Grosse, Thin double layer theory of the wide-frequency range dielectric dispersion of suspensions of non-conducting spherical particles including surface conductivity of the stagnant layer, *Colloids and Surfaces a-Physicochemical and Engineering Aspects* 192(1-3) (2001) 253-265.
- [101] S. Kaufhold, R. Dohrmann, Detachment of colloidal particles from bentonites in water, *Appl Clay Sci* 39(1-2) (2008) 50-59.
- [102] T.R. Madden, Random Networks and Mixing Laws, *Geophysics* 41(Na6) (1976) 1104-1125.

## Graphical abstract

