



**HAL**  
open science

## The DREAMS Experiment Onboard the Schiaparelli Module of the ExoMars 2016 Mission: Design, Performances and Expected Results

Francesca Esposito, Stefano Debei, C. Bettanini, C. Molfese, I. Arruego  
Rodríguez, G. Colombatti, A.-M. Harri, Franck Montmessin, C. Wilson, A.  
Aboudan, et al.

### ► To cite this version:

Francesca Esposito, Stefano Debei, C. Bettanini, C. Molfese, I. Arruego Rodríguez, et al.. The DREAMS Experiment Onboard the Schiaparelli Module of the ExoMars 2016 Mission: Design, Performances and Expected Results. *Space Science Reviews*, 2018, 214 (6), pp.art. 103. 10.1007/s11214-018-0535-0 . insu-01858965

**HAL Id: insu-01858965**

**<https://insu.hal.science/insu-01858965>**

Submitted on 26 Nov 2020

**HAL** is a multi-disciplinary open access archive for the deposit and dissemination of scientific research documents, whether they are published or not. The documents may come from teaching and research institutions in France or abroad, or from public or private research centers.

L'archive ouverte pluridisciplinaire **HAL**, est destinée au dépôt et à la diffusion de documents scientifiques de niveau recherche, publiés ou non, émanant des établissements d'enseignement et de recherche français ou étrangers, des laboratoires publics ou privés.

1 **The DREAMS experiment onboard the Schiaparelli Module of the ExoMars 2016 mission:**  
2 **design, performances and expected results**

3

4 **Authors**

5 F. Esposito<sup>1</sup>, S. Debei<sup>2</sup>, C. Bettanini<sup>2</sup>, C. Molfese<sup>1</sup>, I. Arruego Rodríguez<sup>3</sup>, G. Colombatti<sup>2</sup>, A-M. Harri<sup>4</sup>, F.  
6 Montmessin<sup>5</sup>, C. Wilson<sup>6</sup>, A. Aboudan<sup>2</sup>, P. Schipani<sup>1</sup>, L. Marty<sup>1</sup>, F.J. Álvarez<sup>3</sup>, V. Apestigue<sup>3</sup>, G. Bellucci<sup>7</sup>, J-J.  
7 Berthelier<sup>5</sup>, J. R. Brucato<sup>8</sup>, S. B. Calcutt<sup>6</sup>, S. Chiodini<sup>2</sup>, F. Cortecchia<sup>20</sup>, F. Cozzolino<sup>1</sup>, F. Cucciarrè<sup>2</sup>, N.  
8 Deniskina<sup>1</sup>, G. Déprez<sup>5</sup>, G. Di Achille<sup>24</sup>, F. Ferri<sup>2</sup>, F. Forget<sup>9</sup>, G. Franzese<sup>1,10</sup>, E. Friso<sup>2</sup>, M. Genzer<sup>4</sup>, R. Hassen-  
9 Kodja<sup>5</sup>, H. Haukka<sup>4</sup>, M. Hieta<sup>4</sup>, J. J. Jiménez<sup>3</sup>, J-L. Josset<sup>11</sup>, H. Kahanpää<sup>4</sup>, O. Karatekin<sup>12</sup>, G. Landis<sup>13</sup>, L.  
10 Lapauw<sup>5</sup>, R. Lorenz<sup>14</sup>, J. Martinez-Oter<sup>3</sup>, V. Mennella<sup>1</sup>, D. Möhlmann<sup>15</sup>, D. Moirin<sup>5</sup>, R. Molinaro<sup>1</sup>, T. Nikkanen<sup>4</sup>,  
11 E. Palomba<sup>7</sup>, M.R. Patel<sup>16</sup>, J-P. Pommereau<sup>5</sup>, C.I. Popa<sup>1</sup>, S. Rafkin<sup>17</sup>, P. Rannou<sup>18</sup>, N.O. Renno<sup>19</sup>, J. Rivas<sup>3</sup>, W.  
12 Schmidt<sup>4</sup>, E. Segato<sup>2</sup>, S. Silvestro<sup>1</sup>, A. Spiga<sup>9</sup>, D. Toledo<sup>25</sup>, R. Trautner<sup>22</sup>, F. Valero<sup>21</sup>, L. Vázquez<sup>21</sup>, F. Vivat<sup>5</sup>, O.  
13 Witasse<sup>22</sup>, M. Yela<sup>3</sup>, R. Mugnuolo<sup>23</sup>, E. Marchetti<sup>23</sup>, S. Pirrotta<sup>23</sup>

14

15 **Affiliations**

16 <sup>1</sup>INAF - Osservatorio Astronomico di Capodimonte, Napoli, Italy, <sup>2</sup>CISAS - Università degli Studi di Padova, Padova,  
17 Italy, <sup>3</sup>INTA, Madrid, Spain, <sup>4</sup>Finnish Meteorological Institute (FMI), Helsinki, Finland, <sup>5</sup>LATMOS - CNRS/UVSQ/IPSL,  
18 France, <sup>6</sup>Oxford University, Oxford, United Kingdom, <sup>7</sup>INAF - Istituto di Fisica dello Spazio Interplanetario (IFSI),  
19 <sup>8</sup>INAF-Osservatorio Astrofisico di Arcetri, <sup>9</sup>Laboratoire de Météorologie Dynamique, UMR CNRS 8539, Institut  
20 Pierre-Simon Laplace, Sorbonne Universités, UPMC Univ Paris 06, Centre National de la Recherche Scientifique,  
21 Paris, France, <sup>10</sup>Department of physics – University of Naples “Federico II”, Naples, Italy,, <sup>11</sup>Space Exploration  
22 Institute, Switzerland, <sup>12</sup>Royal Observatory of Belgium, Belgium, <sup>13</sup>NASA, GRC, USA, <sup>14</sup>JHU Applied Physics Lab (JHU-  
23 APL), USA, <sup>15</sup>DLR PF Leitungsbereich, Berlin, Germany, <sup>16</sup>Open University, UK, <sup>17</sup>Southwest Research Institute, USA,  
24 <sup>18</sup>GSMA, France, <sup>19</sup>University of Michigan, USA, <sup>20</sup>INAF – Osservatorio Astronomico di Bologna, Bologna, Italy,  
25 <sup>21</sup>Universidad Complutense de Madrid (UCM), Spain, <sup>22</sup>ESA-ESTEC, Noordwijk, The Netherlands, <sup>23</sup>Italian Space  
26 Agency, Italy, <sup>24</sup>INAF – Osservatorio Astronomico di Teramo, Teramo, Italy, <sup>25</sup>Reims Champagne-Ardenne University,  
27 France.

28

29 **Corresponding author:**

30 Francesca Esposito

31 INAF – Osservatorio Astronomico di Capodimonte

32 Salita Moiariello 16, 80131 Naples, Italy

33 Email: francesca.esposito@na.astro.it

34

35 **Key points**

36 ExoMars; Schiaparelli; DREAMS; Mars; atmospheric electric field; meteorological station; dust  
37 storm season

38 **Abstract**

39 The first of the two missions foreseen in the ExoMars program was successfully launched on 14<sup>th</sup>  
40 March 2016. It included the Trace Gas Orbiter and the Schiaparelli Entry descent and landing  
41 Demonstrator Module. Schiaparelli hosted the DREAMS instrument suite that was the only  
42 scientific payload designed to operate after the touchdown. DREAMS is a meteorological station  
43 with the capability of measuring the electric properties of the Martian atmosphere. It was a  
44 completely autonomous instrument, relying on its internal battery for the power supply. Even with  
45 low resources (mass, energy), DREAMS would be able to perform novel measurements on Mars  
46 (atmospheric electric field) and further our understanding of the Martian environment, including the  
47 dust cycle. DREAMS sensors were designed to operate in a very dusty environment, because it was  
48 designed to land on Mars during the dust storm season (October 2016 in Meridiani Planum).  
49 Unfortunately, the Schiaparelli module failed part of the descent and the landing and crashed onto  
50 the surface of Mars. Nevertheless, several seconds before the crash, the module central computer  
51 switched the DREAMS instrument on, and sent back housekeeping data indicating that the  
52 DREAMS sensors were performing nominally. This article describes the instrument in terms of  
53 scientific goals, design, working principle and performances, as well as the results of calibration  
54 and field tests. The spare model is mature and available to fly in a future mission.

55

## 56 **1. Introduction**

57 The European Space Agency (ESA) has been executing the ExoMars program in cooperation with  
58 the Russian federal Space Agency (Roscosmos). It foresees two elements: the first one, launched on  
59 14<sup>th</sup> March 2016 from Baikonur in Kazakhstan, includes the Trace Gas Orbiter (TGO), currently in  
60 orbit around Mars, and the Schiaparelli lander demonstrator that unfortunately did not land safely.

61 The second mission will be launched in the 2020; it includes a Russian Surface Platform and a  
62 European rover. The whole program will allow Europe to mature the technologies necessary for the  
63 entry, descent and landing of a payload on the surface of Mars, to move on the Martian surface with  
64 a rover, to penetrate into the subsurface and acquire samples and to distribute the collected samples  
65 to on-board instruments for analysis. From the scientific point of view, the ExoMars program will  
66 search for signs of extant or extinct life forms, will monitor trace gases in the atmosphere of Mars  
67 and their sources, will investigate how the water and geochemical environment varies, will monitor  
68 long-term climate and will perform atmospheric investigations (Vago et al., 2015).

69 The 2016 mission arrived at Mars on 19<sup>th</sup> October 2016. The TGO successfully entered into  
70 Martian orbit and started the acquisition of scientific data around the end of November. Its main  
71 scientific objectives are to monitor methane and other trace gases and their sources on the surface of  
72 Mars. Since living organisms produce most of the methane present in the terrestrial atmosphere, the  
73 science community has interest in the monitoring of this gas on Mars.

74 While TGO successfully entered into Martian orbit on 19<sup>th</sup> October, unfortunately the Schiaparelli  
75 module failed to land safely. This module carried the DREAMS (*Dust characterization, Risk  
76 assessment and Environment Analyzer on the Martian Surface*) instrument, that was supposed to  
77 start to operate after the touchdown in Meridiani Planum, an active area from the aeolian point of  
78 view (Chojnacki et al., 2016; Silvestro et al., 2011; 2015). A few seconds before crashing onto the  
79 surface of Mars, Schiaparelli started the sequence of operations foreseen after landing and switched  
80 on DREAMS that proved to be healthy and ready to start measurements.

81 DREAMS is a meteorological station, conceived with a modular architecture, with the capability of  
82 performing measurements of the electric field close to the surface of Mars. It is an autonomous  
83 system that includes its own battery to supply power. It includes the following subsystems  
84 (seeSection 2): MarsTEM (thermometer), DREAMS-P (pressure sensor), DREAMS-H (humidity  
85 sensor), MetWind (2-D wind sensor), MicroARES (electric field sensor), SIS (Solar Irradiance  
86 Sensor), a CEU (Central Electronic Unit) and a battery. It was designed to operate in very extreme  
87 conditions such as during the dust storm season, when it was supposed to land.

88 DREAMS is mature and available for a future mission in order to perform:

89 • Meteorological measurements

90 - The measurements of pressure, temperature, wind speed and direction, humidity and dust  
91 opacity enable to characterize the basic state meteorology and its daily variation at the  
92 landing site.

93 - Such information can directly be compared to climate models.

94 - DREAMS is equipped to characterize the Martian boundary layer, also in dusty conditions.

95 • Hazard monitoring

96 - DREAMS can provide a comprehensive dataset to help engineers to quantify hazards for  
97 equipment and human crew: velocity of windblown dust, electrostatic charging, existence of  
98 discharges, and electromagnetic noise potentially affecting communications, intensity of UV  
99 radiation.

100 • Monitor of atmospheric electric phenomena

101 - A global atmospheric electrical circuit is likely to exist on Mars, between the surface and the  
102 ionosphere, with similarities and differences with the Earth's circuit (Aplin, 2006).

103 Atmospheric ionization should be similar to that of the Earth's stratosphere but impact  
104 charging through collisions between dust particles moved by the wind and the surface, or  
105 between dust particles themselves, is expected to be the dominant charging mechanism.

- 106 Intense electric fields, possibly capable of producing electrical breakdown, are expected at  
107 the time of dust storms and in the vicinity of dust devils.
- 108 - Atmospheric electricity is also involved in several processes that have a noticeable impact  
109 on the surface and atmosphere. At times of dust storms, electrostatic forces on fine  
110 electrically charged dust grains may become larger than aerodynamic forces due to the wind.  
111 They are expected to play a significant role in the dynamics (including lifting) of suspended  
112 dust particles and their interaction with the surface, thus on the processes that contribute to  
113 the erosion and long-term evolution of the surface (Esposito et al., 2016; Harrison et al.,  
114 2016; Murphy et al., 2016).
  - 115 - By energizing the free electrons, the atmospheric electric field control their interaction with  
116 both the surface and the atmospheric gases. They have thus a definite role in the chain of  
117 physical and chemical processes that govern the chemical state of surface materials and the  
118 production of oxidized constituents in the atmosphere with implications on the sustainability  
119 of proper conditions for life (Atreya et al., 2006).

120 A Flight Spare model of DREAMS is mature and available for a future mission.

121 Some of the DREAMS sensors have been tested in the Sahara desert during the dust storm season to  
122 prove their ability to work in a dusty environment and to probe dust events. The field campaign  
123 allowed also the advancement of our knowledge of Aeolian processes and their relation with the  
124 electric properties of the atmosphere.

125 The following sections describe the DREAMS instrument design, sensors performance, and  
126 calibration procedures. Results of the field tests are described in section 4.

127

## 128 **2. The DREAMS experiment**

129 The DREAMS experiment is the result of a cooperation of six European Countries (Italy, France,  
130 Spain, Netherlands, Finland, United Kingdom) led by Italy. The team organization is described in  
131 Figure 1.

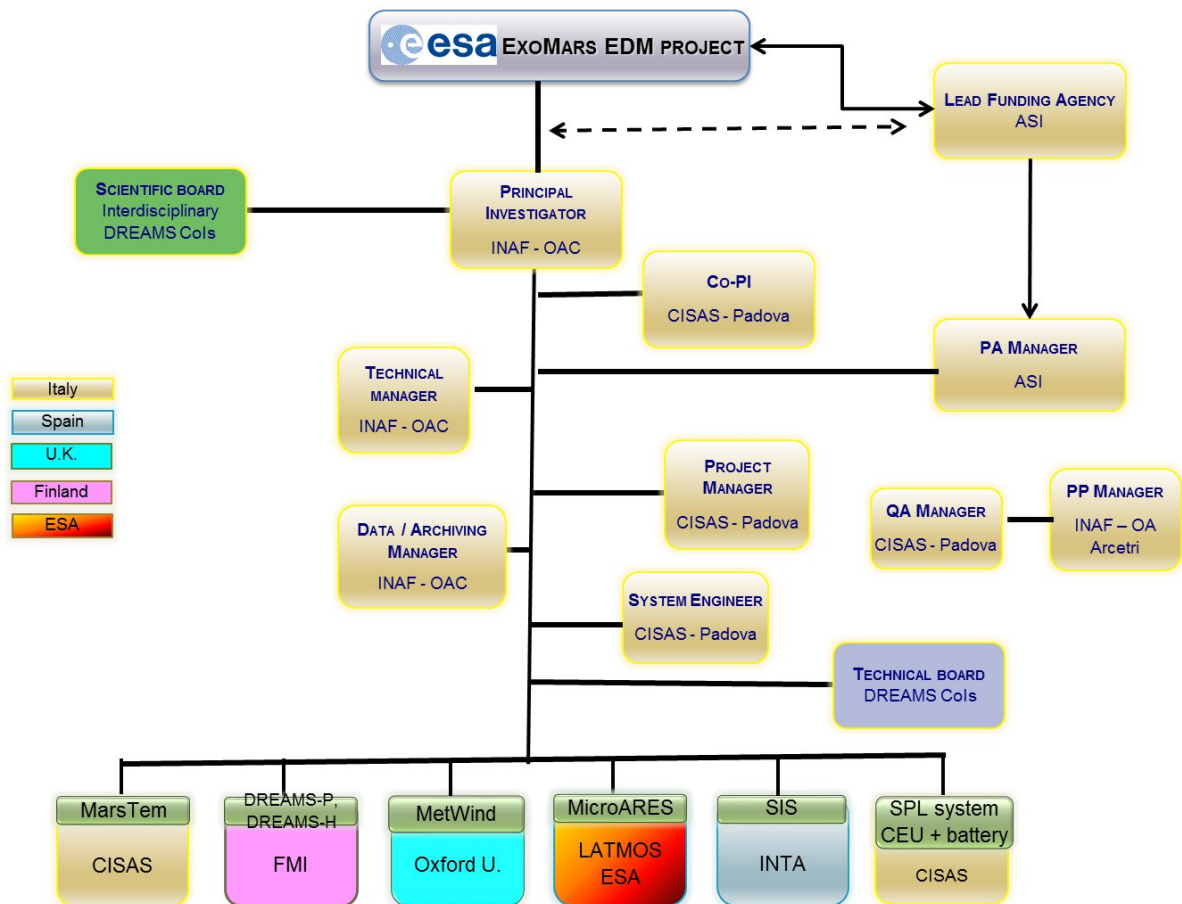

132

133 **Figure 1:** DREAMS team organization.

134

135 DREAMS (Figure 2) is a completely autonomous sensor suite containing the following subsystems:

136 a) the power unit (a space qualified rechargeable battery assembly developed by ABSL), b) the

137 Central Electronic Unit (CEU), comprising all electronic boards for sensor data acquisition and

138 communication with Schiaparelli module, c) the MetMast assembly (about 20.4 cm tall) which

139 hosts most of the external sensors and d) the MicroARES electrode (27 cm tall).

140

141

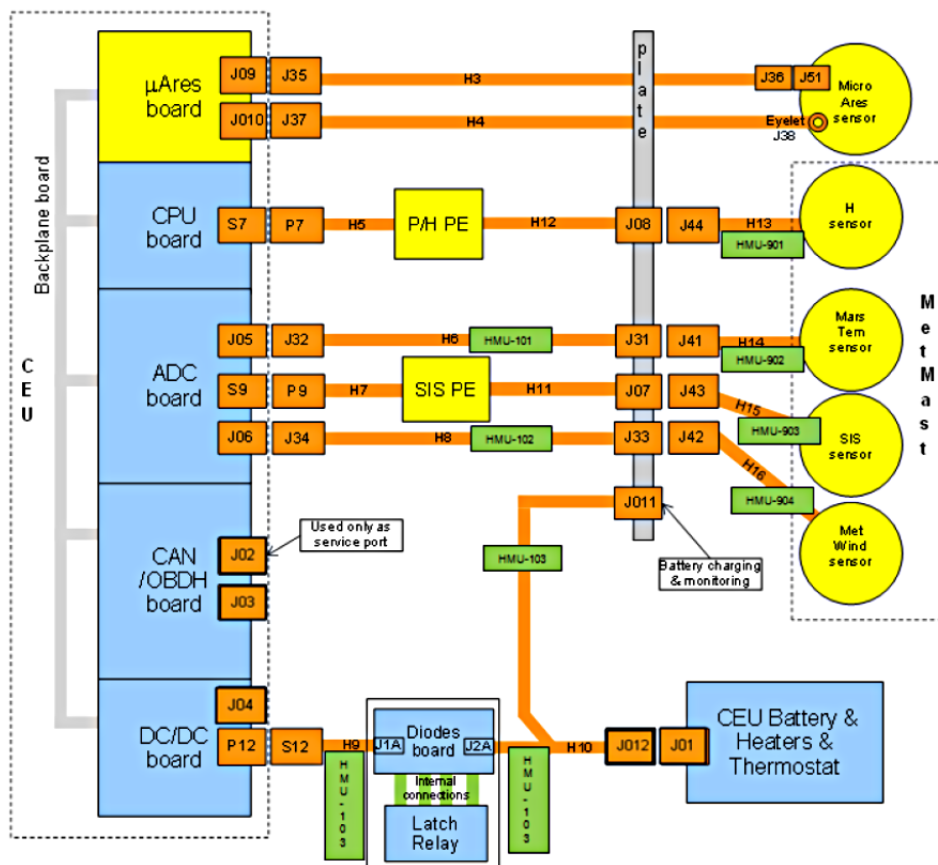
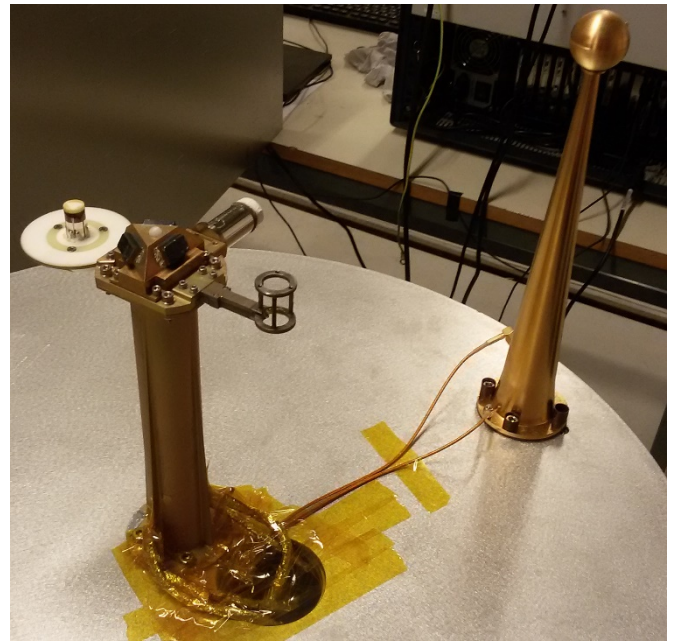
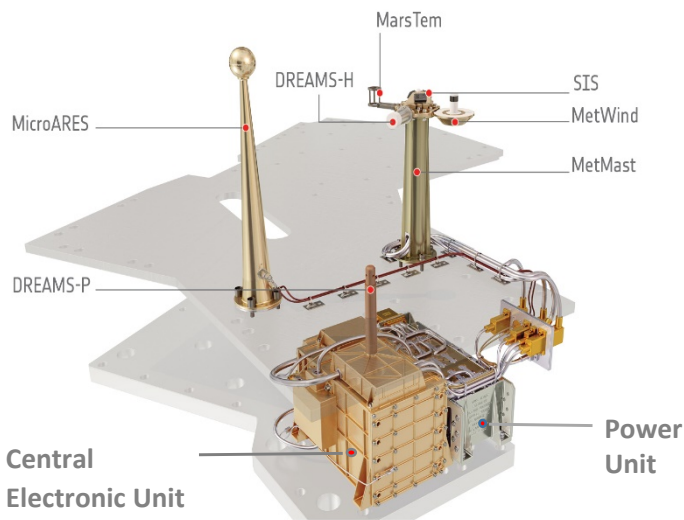

142

143 **Figure 2:** Top left: graphic impression of the DREAMS instrument and its location in the  
 144 Schiaparelli Central Bay. Credit: ESA. Top right: DREAMS spare model: MetMast (on the left) and  
 145 MicroARES antenna (on the right). Bottom: DREAMS block diagram.



146

147 A dedicated harness guarantees the connection of DREAMS hardware located in the internal bay  
148 with the external sensing units and the Schiaparelli control unit through a

149 connector bracket which interfaces the internal compartment with the external environment.

150 The following subsections describe each DREAMS element.

151

## 152 2.1 DREAMS-H

153 DREAMS-H (Figure 3) is a miniature relative humidity measurement device based on technology  
154 developed by the Finnish company Vaisala, Inc. DREAMS-H is functionally and electrically almost

155 an exact copy of REMS-H instrument onboard MSL/Curiosity (Harri et al. 2014b). The mass of

156 DREAMS-H is approx. 15 g and the power consumption is 15 mW.

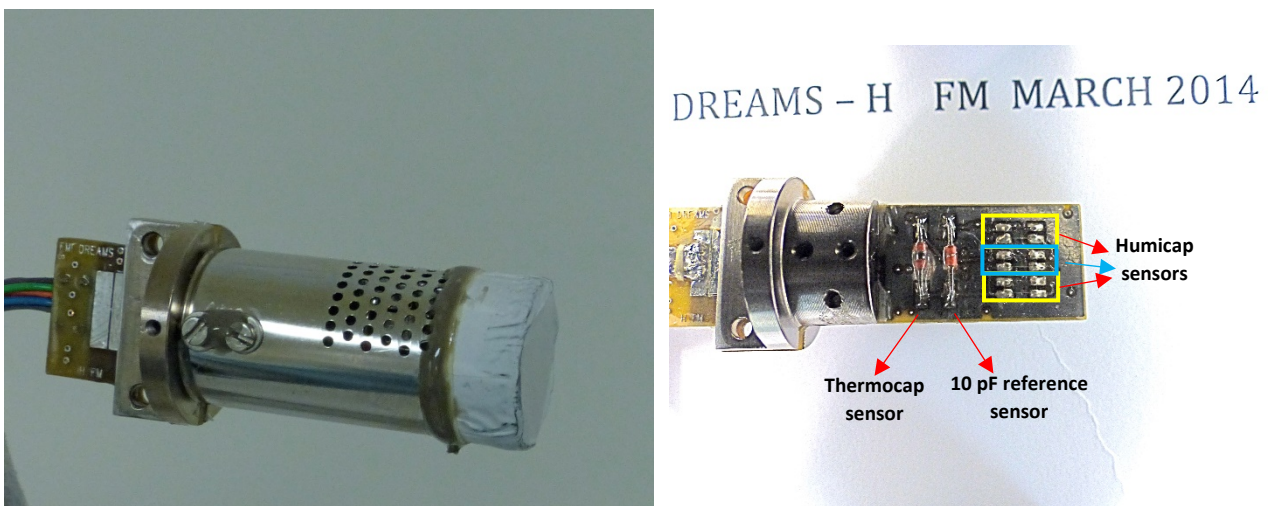

157

158 **Figure 3:** DREAMS-H sensor. Credit: FMI/Markku Mäkelä.

159

160 As REMS-H, DREAMS-H measures relative humidity with 3 Humicap® polymeric capacitive

161 sensor heads, while accurate temperature measurements required for interpretation of relative

162 humidity measurements are provided with capacitive Thermocap® sensor heads, both by Vaisala,

163 Inc. The sensor heads are placed on a single PCB together with proximity electronics, and protected

164 with metallic Faraday cage. The cage is perforated to allow gas exchange between the sensor heads

165 and the surrounding environment. To protect the sensor from excessive dust, part of the holes are

166 covered with a PTFE filter material. The whole structure is mounted on DREAMS mast at about 17  
167 cm height from the top of Schiaparelli Central Bay. DREAMS-H control and data retrieval is  
168 handled by the measurement controller located on the DREAMS-P PCB.

169 The Humicap® sensor heads contain an active polymer that changes its capacitance as function of  
170 relative humidity and temperature with 0 to 100% RH measurement range. In a given temperature,  
171 the response between 0 and 100%RH is very close to linear. The polymer reacts to the relative  
172 humidity even when the device is not powered, so the relative humidity can be read almost  
173 immediately after power-on.

174 Nominal capacitance of Humicap® is in order of 6 pF. The dynamic range of the Humicap®  
175 changes with temperature, being approx. 1 pF around 273K and approx. 0.3 pF around 203K. The  
176 Humicap® also becomes logarithmically slower with lower temperature, its time constant is about  
177 0.1 s at 293K, but for example at 233K it is about 30 s and at 203K about 700 s. Some additional  
178 time lag is added also by the protective PTFE filter. The time lag caused by the coldness and PTFE  
179 filter can be partially mathematically compensated on ground. The compensation algorithm is based  
180 on the relative humidity reading and its speed of change. The basis of this method is the fact that the  
181 speed of change through the filter depends on the atmospheric temperature and the difference of RH  
182 between the inside and the outside. Therefore, the difference in RH can be calculated by knowing  
183 the ambient temperature, and the speed of the change in raw RH values (Harri et al. 2014b).

184

185

## 186 2.2 DREAMS-P

187 DREAMS-P is a miniature pressure sensor designed for making accurate measurements in the  
188 Martian atmosphere surface pressure range. The device houses two pressure transducers and an  
189 integrated measurement controller, which controls the DREAMS-P pressure and DREAMS-H  
190 humidity measurements (**Figure 4**).

191

192

193

194

195

196

197

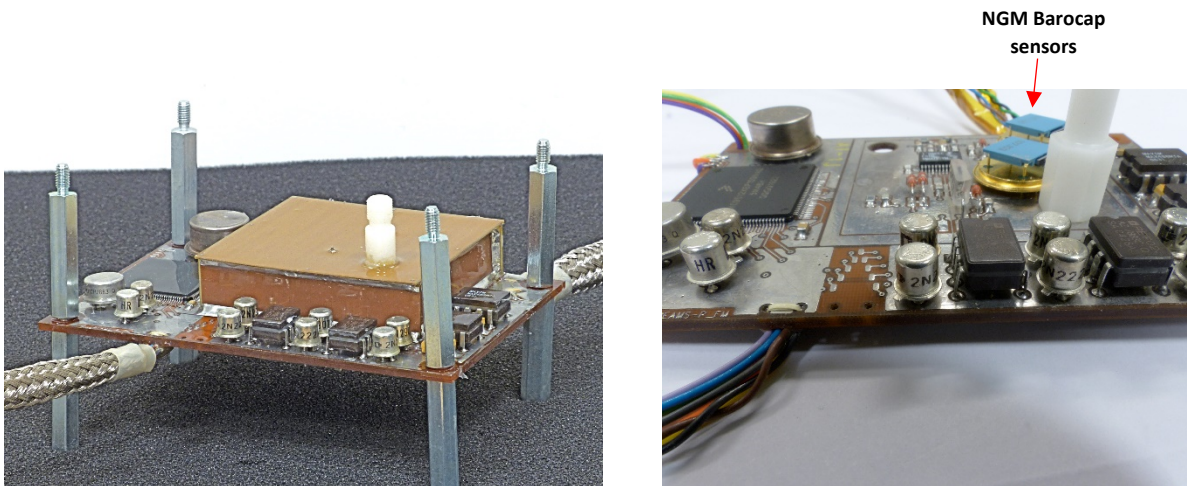

198 **Figure 4:** DREAMS-P sensor with (left panel) and without (right panel) the cover. Credit:  
199 FMI/Markku Mäkelä. The components with blue parts in the right panel are NGM Barocaps. The  
200 RSP2Ms are on the other side of the board.

201

202 The pressure device is based on capacitive Barocap® sensor heads manufactured by Vaisala, Inc.

203 The whole DREAMS-P device is mounted inside the lander warm compartment, with the pressure  
204 transducer electronics being housed inside a Faraday shield, a rectangular enclosure made of copper  
205 covered Printed Circuit Boards, to protect the electronics from electromagnetic  
206 interference. Atmospheric ambient pressure is led inside the device through a pipe protruding above  
207 the lander deck. The top part of pipe outlet is designed to prevent excessive amounts of dust from  
208 entering the system.

209 The device consists of two pressure transducers with heritage from the REMS-P instrument flown  
210 onboard the Curiosity rover (Harri et al. 2014a). Each transducer has two Barocap® pressure sensor  
211 heads, two Thermocap® temperature sensor heads and four constant capacitors for reference. The

212 DREAMS-P2 transducer is essentially identical to the electrical design in REMS-P using the  
213 Barocap® RSP2M sensor heads, while the DREAMS-P1 transducer utilizes the “new generation”  
214 NGM sensor heads by Vaisala, specifically modified for Martian pressure range. This sensor head  
215 replaces the now obsolete "LL" sensor head used in Phoenix pressure sensor and REMS. The NGM  
216 has no previous flight heritage, but it has been fully qualified for spaceflight during DREAMS  
217 testing and qualification campaign.

218 The pressure dependence of Barocap® capacitance is opposite in RSP2M and NGM. In RSP2M,  
219 higher ambient pressure pushes the capacitor plates inside the sensor head further away from each  
220 other, thus lowering the capacitance. In NGM, one of the capacitor plates is at the bottom of the  
221 vacuum cavity inside the sensor head, and so higher ambient pressure pushes the capacitor plates  
222 closer to each other, increasing the capacitance until the plates touch in approx. 70 hPa and the  
223 sensor head is shorted. Thus NGM can only be measured in low pressures below this limit.

224 The RSP2M sensors offer fast warm up time and high resolution, which means that they are very  
225 suitable for short intermittent measurements. The new NGM sensors offer even better resolution  
226 and long term stability than the RSP2Ms, but require a longer warm up period in the beginning of  
227 each measurement sequence.

228 A low-power measurement controller is integrated on the DREAMS-P device circuit board. The  
229 controller is based on the Freescale MC9S12XEP100 automotive commercial-off-the-shelf  
230 microcontroller (MCU). The MCU was qualified for use as part of Mars lander missions by a  
231 custom qualification process led by the Finnish Meteorological Institute (Nikkanen et al. 2015). The  
232 measurement controller provides power and control signals for the integrated pressure transducers  
233 and the external humidity transducer. The DREAMS CEU issues telecommands to and receives  
234 measurement telemetry and instrument status from the DREAMS-P controller through a RS-422  
235 data interface. During measurements, the active transducer acts as a multiplexed RC oscillator and  
236 generates a set of eight frequency signals. Pressure or humidity readings are obtained by data  
237 analysis after defining the frequencies on these transducer sensor and reference channels. A stable

238 reference crystal clock frequency is utilized to measure the duration of a given amount of sensor or  
239 reference channel pulses to derive each measurement channel frequency.

240

### 241 **2.3 MarsTEM**

242 MarsTEM is a platinum Resistance Temperature Detector (RTD) for the measurement of the  
243 atmospheric temperature at the surface of Mars. (Colombatti et al., 2014).

244 In order to measure the temperature the convective flux is detected by a thin ( $\phi = 0,0508$  mm) and  
245 long platinum wire ( $L = 700$ mm) which lead to a resistance of 37.8 ohm @ 0 °C and a time constant  
246 of 0.3 seconds at a wind speed of 5 m/s and absolute pressure of 6 hPa.

247 The sensor wire is wounded on an insulating structure (Titanium alloy) to minimize the conductive  
248 heat flux from the sensor wire and structure. The structure hosts a secondary Platinum RTD, made  
249 from the same thin wire of the primary, which provides redundancy (e.g. in case the wounded  
250 sensor is damaged by dust). Simultaneous acquisition of both sensors allows for the dynamical  
251 correction of primary sensor in data post-processing (Figure 5). In addition, from the retrieved  
252 titanium structure time constant, the secondary thermometer will support the correction of errors  
253 introduced by solar radiation contribution on the primary sensor. Chiodini et al. (2014) showed that the  
254 radiative contribution of the thermal flux on the sensor is lower than the 30% at noon conditions (the worst  
255 from this point of view) with a wind of 1m/s and that this contribution decreases to 20% with a 5 m/s wind.  
256 The radiative flux contribution produces an increase of about 1.5 °C in the temperature of the sensing  
257 element. Anyway, most of this contribution is due to the radiative flux arriving on the sensor from the  
258 structure itself and not directly from the sun. Similar increase in temperature has also been observed in the  
259 test field performed in the Moroccan desert (Colombatti et al., 2015). Primary and secondary sensors are  
260 sensed with a 3-wires configuration circuit allowing conditioning and acquisition of voltage through  
261 the DREAMS electronics.

262 To minimize the self-heating and to achieve anyway high electrical sensitivity, the sensors are  
263 powered with a pulsed current profile. In such a way the rms current value is very low, which

264 means negligible joule effect, while instantaneous current value is high to maximize the sensors  
265 electrical sensitivity. MarsTEM design and realization, including its conditioning circuitry, were  
266 validated through the Missus Experiment flown on BEXUS15 ESA/SSC/DLR stratospheric  
267 balloon, which hosted the sensor prototype and the conditioning circuitry.  
268 The terrestrial absolute pressure at about 30 km of altitude is an analogue of Martian pressure at the  
269 surface. Missus allowed the validation of the mathematical model (even of sun irradiance effects)  
270 and the tuning of the electrical current profile in order to maximize sensitivity/self-heating ratio and  
271 the overall SNR. To infer MarsTEM performance from MISSUS experiment results, the  
272 comparison between Earth and Mars potential temperature was performed (Chiodini et al., 2014).  
273 MarsTEM performances were obtained during calibration within the range  $-100\text{ }^{\circ}\text{C} + 20\text{ }^{\circ}\text{C}$ .

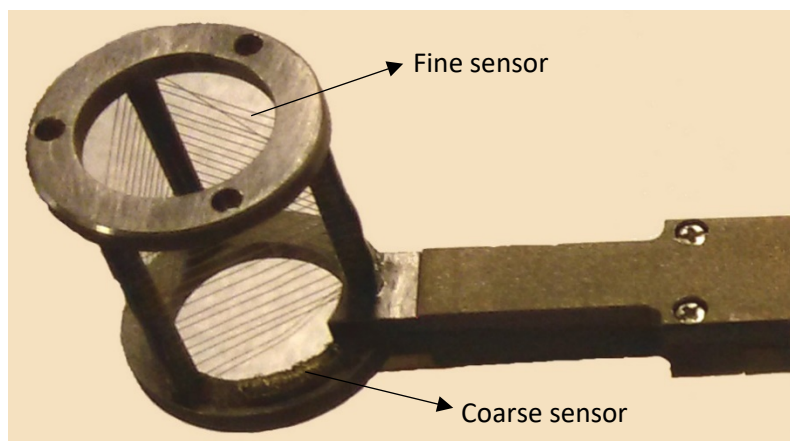

274  
275 **Figure 5:** MarsTEM sensor with the fine and coarse subsystems indicated.  
276

277

## 278 2.4 MetWind

279 MetWind is a thermal anemometer that measures the components of wind speed and direction in the  
280 plane perpendicular to the sensor axis. The sensor head consists of three thin-film platinum heat  
281 transfer gauges, equally spaced around the circumference of a vertical cylinder (Figure 6). Each  
282 film is resistively heated using a constant current raising its temperature above the ambient air. The  
283 film's electrical resistance is measured, allowing calculation of the temperature and thus the heat  
284 transfer coefficient at each hot film. The differences in heat transfer coefficients between the three



285 films is used to calculate a two-dimensional wind vector perpendicular to the axis of the wind  
286 sensor. In its normal orientation the axis of the central cylinder is vertical, so that the sensor  
287 measures a horizontal wind vector. The sensor is calibrated for the range of 0.3 – 30 m/s although  
288 wind speeds above this range can be measured as well.

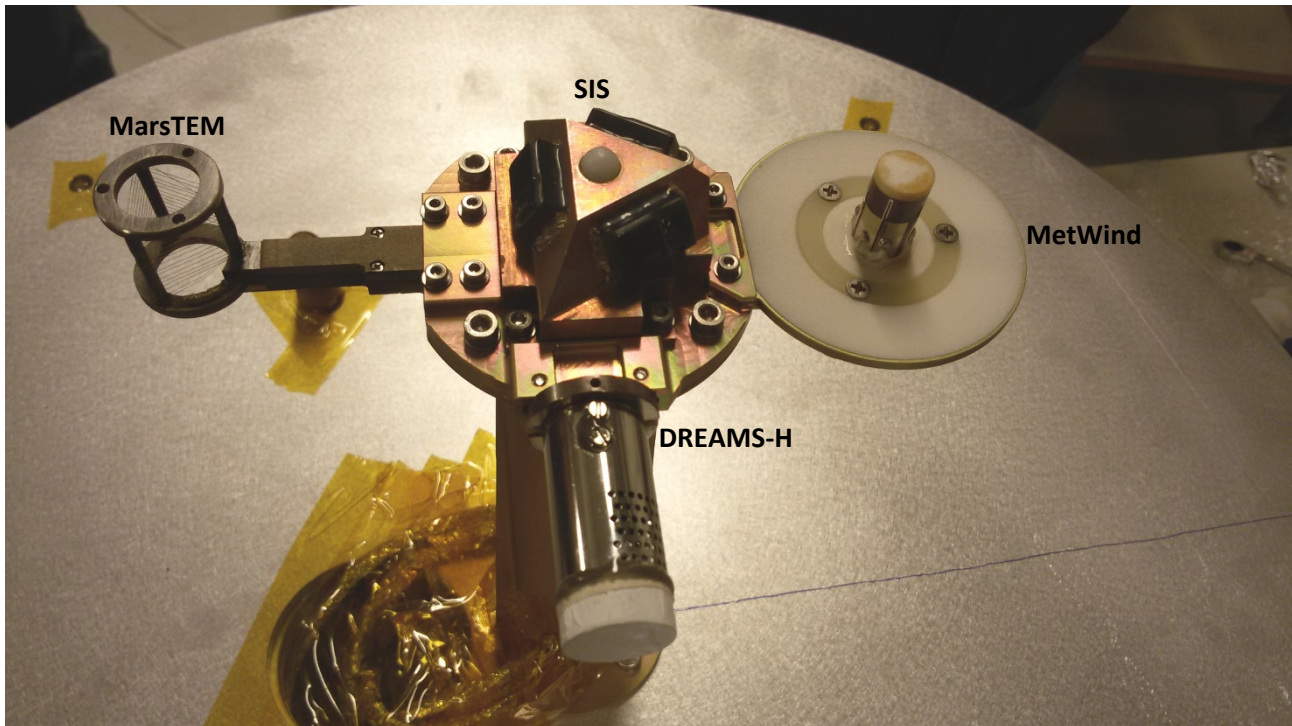

289 **Figure 6:** MetMast top view.

290

291 Thermal wind sensors have a long heritage on Mars. These include the Viking Lander wind sensors;  
292 the Mars Pathfinder wind sensor, Mars Polar Lander wind sensor, and the Mars Science Laboratory  
293 wind sensor. Principle advantages of thermal anemometry are the low mass and simplicity of  
294 thermal wind sensors. Balanced against this advantage is the fact that thermal wind sensors are  
295 difficult to calibrate, because they are sensitive not only to wind but also to other thermal loads,  
296 such as those caused by changes in air temperature and solar illumination.

297 MetWind reuses the Beagle 2 Wind Sensor design (Towner et al., 2004; Wilson et al., 2003), with  
298 the addition of a housekeeping sensor: a platinum resistance thermometer that has been placed in  
299 the center of the sensor. The data from this thermometer supports the calculation of the conductive

300 heat losses, which would otherwise be one of the largest sources of uncertainty in interpreting the  
301 wind speed data.

302 The MetWind thermal anemometry technology is similar to that used on Mars Pathfinder (Seiff et  
303 al., 1997). Wind speed data acquired by the Mars Pathfinder sensor has not been published because  
304 of large uncertainty in the overheat ( $T_{wire} - T_{air}$ ), which in turn was caused by large fluctuations in  
305 the air temperature (up to  $\pm 10^{\circ}\text{C}$  during the day). This air temperature fluctuation is large in  
306 comparison to the overheat of the sensor wire, which was only  $1\text{-}10^{\circ}\text{C}$  for the Pathfinder sensor.  
307 The overheat of the Beagle 2 wind sensor's hot films would have been typically  $50\text{-}70^{\circ}\text{C}$ , and for  
308 MetWind this was increased to  $70\text{-}85^{\circ}\text{C}$  by adjusting resistances; this greater overheat reduces the  
309 measurement error in wind speed.

310 The MetWind electronics are designed to allow two sensing modes. The first is a low-current mode  
311 ('TEMP' mode), in which only 1 mW of heating power is dissipated in the films. In this mode the  
312 self-heating is only  $\sim 2^{\circ}\text{C}$ , and is relatively insensitive to wind speed. In this mode, therefore, the  
313 wind sensors can be used to provide a backup measurement of air temperature; it also provides a  
314 way of check whether the film resistances have changed with time, or example due to sand  
315 abrasion.

316 On power-up, the electronics are typically started in the low power (TEMP) mode. After 30  
317 seconds, MetWind is switched to high power mode (WIND) mode, in which  $\sim 40$  mW are dissipated  
318 in each film. The electronics then remain in WIND mode until they are next powered off and back  
319 on again.

320

321 The response time of the sensor to step changes in wind speed is  $\sim 2\text{-}5$  seconds, dependent on wind  
322 speed and direction. This is sufficient to allow characterization of large-eddy turbulence and  
323 detection of convective vortices.

324 MetWind is extremely light: the sensor head itself weighs only 0.7 grams. Once its mounting  
325 screws and 400 mm harness are taken into account the total mass is 11 grams, excluding connectors



326 and electronics (which are included in the CEU). Total power consumption while sensing wind is  
327 around 250 mW, of which 120 mW are dissipated in the sensor head.

328

## 329 **2.5 MicroARES**

330 Micro-ARES is a single probe electric field instrument consisting of a spherical electrode installed  
331 on a stiff metallic support (Figure 2) and a single electronics board housed in the common electronics  
332 box (DREAMS CEU) placed in the warm compartment.

333 The predecessor of MicroARES called ARES (proposed in a double probe version, see for instance  
334 Berthelier et al., 2000) has been validated on two balloon flights and was developed as part of the  
335 HUMBOLDT platform payload (and successfully passed the Preliminary Design Review) in a  
336 previous configuration of the ExoMars mission.

337 MicroARES measures the amplitude of the vertical component of the electric field in the atmosphere,  
338 with the lander potential as reference. A high impedance ( $10^{14} \Omega$ ) preamplifier is mounted in a voltage  
339 follower configuration yielding a precise measurement of the surrounding atmospheric potential; the  
340 Mars near surface atmosphere is a medium whose typical resistivity is  $>10$  smaller than the  
341 MicroARES instrument impedance (Farrell et al., 2015).

342 In the Analog portion of the electronics board, the signal is separated in two components: (1) the large  
343 amplitude (mV to V) and low frequency ( $<10$  Hz) signal of the DC channel and (2) the small  
344 amplitude ( $10^{-3}$  mV) and high frequency (100 Hz to kHz) signal of the AC channel. The difference  
345 between the two resides in the capacitive coupling of the AC channel with the antenna, which  
346 effectively suppresses the main component of the signal received from the sphere. The high sensitivity  
347 of the AC channel can be used to detect the impacts of charged dust particles to let one infer their  
348 horizontal flux and charge distribution.

349 A high voltage mode is automatically activated by the Micro-ARES central computer (a Texas  
350 Instrument® Digital Signal Processor, hereafter referred as to DSP) when the modulus of the acquired  
351 potential exceeds 90V for a certain amount of time (typically a fraction of second). This high voltage

352 mode disrupts the equilibrium of potentials between the antenna and the atmosphere by bifurcating  
353 the input signal into a resistive bridge dividing the signal by a factor of >50 and forcing it to cope  
354 with the voltage range admitted by the 16 bits ADC.

355 When operated in the *relaxation probe mode*, the instrument measures of the atmospheric  
356 conductivity separately for positive and negative ions. Periodically, +1V and -1V pulses are  
357 sequentially injected by capacitors into the antenna, creating a small and temporary departure from  
358 equilibrium between the potential of the antenna and that of the atmosphere surrounding it. Positive  
359 and negative ions flowing around the electrode are then attracted by the antenna surface depending  
360 on the pulse polarity to fill in the gap of potentials with a characteristic e-folding relaxation time. This  
361 provides data for estimating the positive and negative conductivities.

362 MicroARES computing capabilities are ensured by a Digital Signal Processor (DSP) from Analog  
363 Devices® (model ADSP-2189). This DSP has a 13 ns instruction cycle time and can handle 75 MIPS.  
364 It is particularly notable for its large on-chip memory (1.5 Mbits) and its low power features (2.5v).  
365 As the ADSP-2189 cannot be procured in a space-qualified version, it received the needed screening  
366 and qualification (Construction analysis, Highly Accelerated Stress Tests, Life test, Single Event  
367 Effects and Total Ionisation Dose testings) to verify that proper operations would be carried out once  
368 at Mars. The main DSP tasks are setups and commands of the analog part, real time signal processing  
369 (data decimation, filtering, selection and conditioning), and ensures communication with the CEU.

370

371

## 372 **2.6 SIS**

373 SIS (Solar Irradiance Sensor) is a radiometer designed to measure solar irradiance on the Martian  
374 surface. Its main goals are: (a) to provide an estimation of the atmospheric optical depth (OD) and  
375 its variations within a Sol; (b) to allow for the detection of clouds through the analysis of the shape  
376 of the ratio between the signals measured in two different spectral bands (UV and NIR) during  
377 twilight; and (c) to provide a direct measurement of the global irradiance on the surface.

378 It consists of two units, an optical head (OH) and a processing electronics (PE) box. OH contains  
379 the detecting elements and front-end electronics, whereas PE acquires and digitizes the signals  
380 provided by the OH, controls the sensor and communicates with the CEU. OH is located on top of  
381 the DREAMS MetMast (Figure 2, Figure 6). This placement severely constrained the OH mass to  
382 less than 26g. OH contains 7 different silicon photodetectors distributed on 4 faces: one bare silicon  
383 detector with a spectral response of 200-1100 nm pointing to the instrument's zenith, and three pairs  
384 of "lateral" detectors covered with filters in the UV and NIR bands (UV: 315-400 nm; NIR: 700-  
385 1100 nm), pointing to an elevation of 30 degrees and azimuths of 60, 180 and 300 degrees within  
386 the OH reference frame. The detectors are commercial-of-the-shelf photodiodes that are covered  
387 with custom interference filters to provide the desired spectral response. OH contains an eighth  
388 detector inside its mechanical assembly, covered by a lid to inhibit light reception. The dark current  
389 of this detector is measured to estimate the displacement damage suffered during the trip to Mars  
390 (Jiménez et al., 2012). Each lateral detector is covered by an interference filter and a mechanical  
391 mask that provides the desired Field-of-View (FoV). This FoV is around  $\pm 40$  degrees when  
392 measured to a 10% of the maximum responsivity. The zenith detector is covered with a diffusing  
393 dome that provides a quasi-planar hemispherical FoV. The signals of the SIS detectors, together  
394 with some housekeeping signals, are conditioned and multiplexed within the OH. Small footprint,  
395 precision, low-noise, low-power and Rail-to-Rail COTS (Commercial-Of-The-Shelf) operational  
396 amplifiers were selected, qualified and screened for the Front-End SIS electronics. Tests of these  
397 parts included radiation (TID, up to 30 krad) (Álvarez et al., 2014), vibration, shock, thermal  
398 cycling and operation in extreme temperature (down to -135 °C). The photodetectors and the optical  
399 elements were also tested using similar procedures.

400

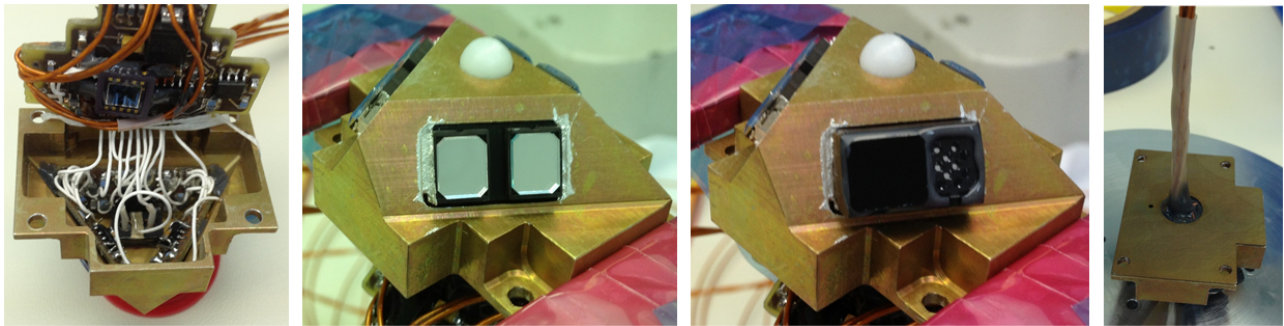

401

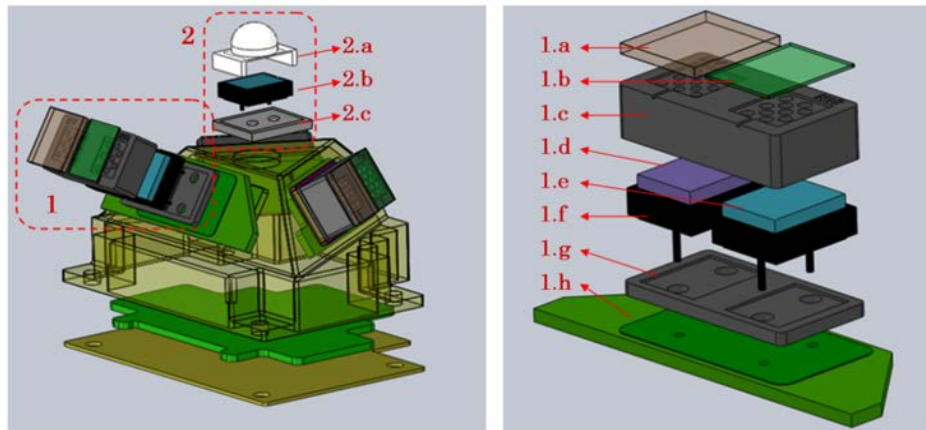

402 **Figure 7:** Top: Views of SIS-OH during the integration process. Bottom: Detail of the Optical  
403 Head elements. 1.a, b: external UG-11 (on the UV detector) and Teflon sheet (NIR one) covers. 1.c:  
404 FoV-shaping element. 1.d,e: interference filters. 1.f: silicon photodiodes. 1.g: radiation shield  
405 (added to ensure a minimum thickness of aluminum for radiation protection). 1.h: printed circuit  
406 board with the current-to-voltage amplifiers. 2.a: diffusing dome covering the unfiltered detector.  
407 2.b: silicon photodetector (without any filter). 2.c: radiation shield.

408

409 The PE is a small processing unit that performs the analog-to-digital conversion of the signals  
410 received from the OH, plus some others internally generated at PE, stores the resulting information,  
411 and communicates with DREAMS CEU in order to control the operation of SIS and to send the  
412 resulting data packets. The unit is based on space grade parts, being its core an anti-fuse FPGA. PE  
413 offers two possible operation modes, namely Manual and Automatic. In the Manual mode, the unit  
414 is always the slave in a Master/Slave communication in which the CEU must command a new  
415 acquisition and data returning each time it wants to get some data from SIS. In the Automatic mode,  
416 the CEU commands SIS to perform automatic acquisitions of all its signals without further  
417 intervention of CEU and according to a desired sampling period form. Then SIS operates

418 autonomously storing data on its internal memory (up to 128 kB), until it is requested to stop and  
419 dump the data to CEU, or until the memory gets full.

420 PE also incorporates a MEMS (Micro Electro-Mechanical System) accelerometer to determine the  
421 tilt of the lander on the surface of Mars. This is also a COTS part that was qualified and screened  
422 for use in DREAMS. Intensive tests include radiation, vibration, shock, vacuum, and thermal  
423 cycling (Álvarez et al., 2015).

424

## 425 2.7 CEU

426 The CEU (Central Electronic Unit) is a modular unit (Figure 8) designed to provide all primary  
427 functionalities needed for operation, data acquisition and communication as timeline-based  
428 environmental operative sequences, analogue to digital conversion for the analogue environment  
429 sensors, power transformation and supply for all sensors/conditioners. The unit also performs data  
430 compression to meet the requirements on data volume budget for the ExoMars mission and realizes  
431 data packetization for telemetry transfer to the EDM on board computer using non-volatile mass  
432 memory for data storage.

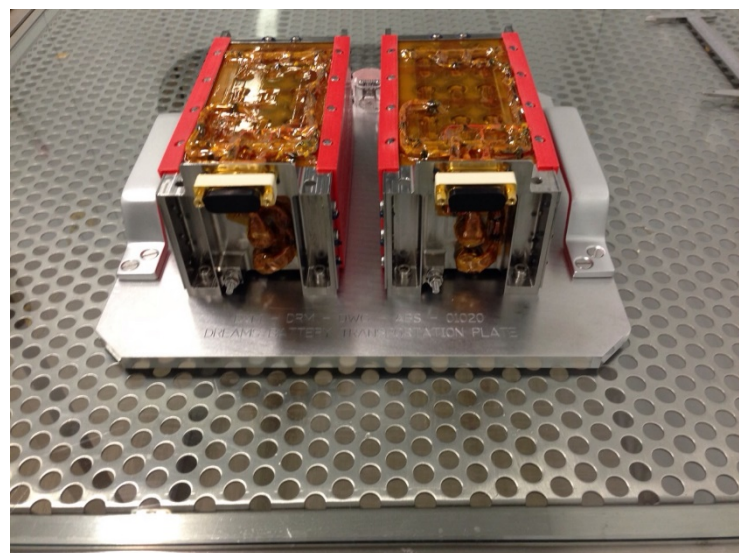
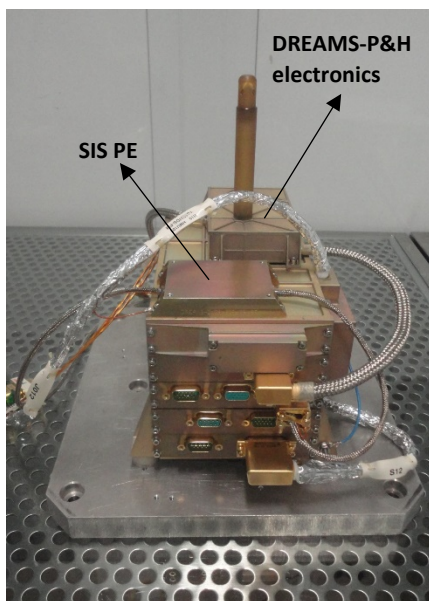

433

434 **Figure 8:** Left: CEU FM; right: two models of the battery units.

435 The CEU is able to execute self-test and to provide information of status and sensors health during in  
436 flight checkouts.

437 The modular design is based on a plug-in configuration, splitting functionalities into different boards  
438 connected through a common backplane; the boards installed on the ExoMars 2016 flight unit are:

- 439 • OBDH Board implements the control layer of the CEU: stores and applies the Data Acquisition  
440 Timelines, interprets and forwards the telecommands coming from EDM to the peripheral boards  
441 (including data on power source use), collects the housekeeping data, acquire sensors data, stores  
442 HK and sensor data in a devoted 4 Gbit nonvolatile memory and uploads the data to the EDM  
443 for transmission to relay orbiter and then back to Earth;
- 444 • DC/DC Board performs the power distribution to lines of CEU boards and of each sensor  
445 according to the profile of each mission phase;
- 446 • CPU Board compresses high volume data with dedicated algorithms depending on specific  
447 structure of data packets. This board also incorporates all the physical layers of the interfaces  
448 towards the MicroARES board and DREAMS P/H sensor;
- 449 • MicroARES Board is integrated in a dedicated slot of CEU, and performs the control of power  
450 and data handling of the MicroARES sensor;
- 451 • ADC Board performs conditioning and acquisition of signals of analogue sensors depending on  
452 operative timelines. The data collected are transferred to the OBDH Board for storage and  
453 transmission.
- 454 • The CEU assembly hosts a relay module used to switch the power from the main bus to the  
455 DREAMS own Battery. In addition a devoted timer, which convert UTC into Mars Local time, is  
456 operative all along the scientific mission. It synchronizes the data communication from to lander  
457 electronics, and it allows the Mission Timeline execution.

458 Overall dimensions are 180 mm x 151 mm x 136 mm with a total mass for the complete flight model  
459 of 2219 g.

460  
461  
462  
463  
464  
465  
466  
467  
468  
469  
470  
471  
472  
473  
474  
475  
476  
477  
478  
479  
480  
481  
482  
483  
484  
485

## 2.8 Battery

DREAMS power source for autonomous operation on Mars is a rechargeable battery (Figure 8), based on Li -Ion rechargeable cells arranged in 8s3p lay-out, containing 3 strings in parallel, each consisting of 8 cells in series. Nominal voltage for fully charged battery is 33.6 V and an overall battery capacity of 6.9 Ah.

Charging and discharging sequences before launch are realized through a 7 pin micro connector installed on Warm Compartment connector bracket, using dedicated ground support equipment compatible with ISO 7 environment specifications. Last battery charging for DREAMS flight unit was performed on January 20<sup>th</sup> 2016 in Baikonur before closing Schiaparelli for final preparation for launch.

Overall battery envelop is 200 mm x 100 mm x 95 mm with a total mass of flight unit of 1691 g.

Mechanical structure of battery includes heaters and thermostats (nominal and redundant) to keep the battery temperature within the required temperature range ( -17°C, +50°C ) , while controlling relays are mounted on a side of CEU unit and commanded through the CEU DC/DC board.

Lifetime prediction of the battery for nominal operation on Mars is around two sols taking into account charge depletion during launch preparation and cruise to Mars and the power needed for temperature control.

The DREAMS power consumption has been measured during environmental testing for all possible operational states foreseen during cruise and on Mars surface; at the nominal battery voltage of 28V an average power consumption of 5.60 W has been measured in Cruise and Surface states, that rises to 7.84 W during acquisition, a consumption of 6.72 W in Upload state and of 0.28 W in idle state.

The DREAMS overall mass, as measured on the Flight Model, is 4362 g.

### 486 3. DREAMS calibrations and performances

#### 487 3.1. Calibrations

488 DREAMS sensors have been calibrated individually by the various lead team members. The  
489 overall calibration has been then verified at the DREAMS project level.

##### 490 3.1.1. DREAMS-H

491 Calibration of DREAMS-H has been done in similar way as calibration of REMS-H (Harri et. al.  
492 2014b). Three flight grade models, Flight (FM), Spare (FS), and Ground reference (REF), were  
493 manufactured at the same time, using parts from the same lots, and calibrated simultaneously.  
494 Temperature calibration of Thermocap® sensor heads has been performed at several stable  
495 temperatures between 203K and 333K. The resulting accuracy of the temperature readings by  
496 Thermocap® is better than +/-0.1K compared to the used reference Pt100 sensor, which in turn has  
497 calibration traceable to national standards.

498 For room temperature measurements, a simple humidity calibration function without temperature  
499 compensation was determined from the measurements made in several humidity points in 295K  
500 temperature. This simple calibration function is only to be used for interpreting measurements made  
501 close to the room temperature (above 283K), with approx. +/-4% RH accuracy.

502 For low temperature (<273K) measurements, DREAMS-H dry (0%RH) calibration curve was  
503 established from measurements performed in vacuum in the temperature range of 203...293K, and  
504 saturation (~100%RH w.r.t. ice) curve from measurements performed in saturated air in 203...250K  
505 temperature range. These two temperature-dependent calibration curves, dry and saturation, are the  
506 basis of the nominal calibration function of DREAMS-H. To determine the response of DREAMS-  
507 H between dry and saturation points more accurately than with a simple linear fit, intermediate  
508 humidity points of approx. 30%, 60%, and 90%RH w.r.t. ice were also measured in the calibration  
509 facility of the Finnish Metrology Center (VTT) in several stable temperature points between 203K  
510 and 263K. To determine the response of DREAMS-H in changing humidity and temperature  
511 conditions, also measurements in varying conditions (so called “Mars sol simulation”) were



512 performed. The main calibration was done in ambient pressure, air, except for the dry curve which  
513 was done in vacuum. The CO<sub>2</sub> effect on Humicap capacitance was measured separately.  
514 Indeed, CO<sub>2</sub> affects the capacitance of the Humicaps, the effect being larger in high pressure and  
515 cold temperature. In Martian pressure range the effect is negligible for temperatures above 263K,  
516 but in colder cases it has to be compensated. For this, dry point curve of DREAMS-H ground  
517 reference model (REF) was measured also in 8 hPa CO<sub>2</sub> environment in the temperature range of  
518 203...293K, and compared to the curve measured in vacuum. Based on these measurements, the  
519 temperature dependent offset caused by CO<sub>2</sub> for the dry curve was calculated. The offset was of the  
520 same order for all 3 Humicaps on DREAMS-H REF, and also for the Humicaps on REMS-H REF  
521 device, for which dry point comparison in vacuum and 8hPa CO<sub>2</sub> was also made. The DREAMS-H  
522 Humicap capacitances measured on Mars shall be adjusted by this offset before calculating  
523 calibrated humidity values. Also wet point verification measurements with DREAMS-H and  
524 REMS-H reference models in low pressure CO<sub>2</sub> environment are under way.  
525 The details of the calibration procedure will be published in a separate paper.  
526 With the calibration based on the measurements made at FMI and Finnish Metrology Center, and  
527 using the mathematical compensation for the Humicap® chip lag in cold temperatures and the  
528 PTFE filter effect, the accuracy of humidity measurements in changing temperature and humidity  
529 conditions is better than +/-10%RH in the temperature range of 203...273K, and in order of +/-  
530 20%RH in the temperature range of 190...203K. In dry conditions (RH < 10%), better accuracy of  
531 +/-4%RH over the whole operational temperature range is achieved.

532

### 533 *3.1.2. DREAMS-P*

534 The calibration of DREAMS-P was performed in August 2014 at FMI, in air environment. The  
535 Barocap measurement principle is based on the medium gas pushing the capacitance plates closer or  
536 further away from each other. This plates movement is not affected by CO<sub>2</sub>. There is no polymer in  
537 this case, that would react to different gases as with Humicap sensors. In the sensor level calibration

538 the output of the pressure sensor was measured in several pressure and temperature points under  
539 stable and under changing temperature. The stable temperature measurements were performed in  
540 the range of 0-1400 Pa (vacuum to Martian pressure range) with 100 Pa intervals and in -45°C to  
541 +55° C temperature (operational temperature range inside DREAMS CEU box) with max 15°C  
542 intervals. In the measurements under changing temperature, pressure was kept at 800 Pa while  
543 temperature was swept over the operational range down and up, once with as fast rate as possible,  
544 and once slower, simulating an actual sol in the mission based on thermal modeling of the CEU. A  
545 Vaisala PTB201 pressure transmitter modified for the Martian pressure range and MKS Baratron 10  
546 Torr pressure transmitter were used as pressure references. The accuracy of the reference sensors is  
547 0.2 Pa and their calibration is traceable to national standards. The reference temperature was  
548 measured with Pt100 sensors with calibration also traceable to national standards.

549 Based on results of environmental tests and experience from previous planetary missions, it was  
550 known that the pressure dependence of Barocap® sensor heads is extremely stable, but small  
551 changes in temperature dependence and offset may occur, especially after integrating the sensor  
552 inside the CEU. To determine these changes, calibration check was performed in vacuum at  
553 DREAMS level, after integrating DREAMS-P in CEU. Several calibration checks were also  
554 performed during the interplanetary cruise using vacuum as reference. Readings measured in the  
555 last cruise check-out were used to compensate the offset drift during storage and cruise (as reported  
556 in Sect. 3.2).

557 Based on the calibration checks performed at sensor and DREAMS level, it can be concluded that  
558 in general, in both transducers, Barocaps on channel 2 have better performance than Barocaps on  
559 channel 1, so they should primarily be used for scientific purposes. The total accuracy of Barocap  
560 #2 is 2.7 Pa for DREAMS-P1, and 3.2 Pa for DREAMS-P2. The repeatability, meaning maximum  
561 artificial variation on diurnal time scale (peak to peak), is 1.4 Pa for P1 and 2.5 Pa for P2, and the  
562 resolution 0.1 Pa for P1, and 0.5 Pa for P2. These performance parameters are valid after the  
563 sufficient warm-up time has passed from the powering of each oscillator (8 min for P1, 2 s for P2).

564 Table 1 summarizes the performances of DREAMS-P.

Oscillator	1 DREAMS-P1 (NGM)		2 DREAMS-P2 (RSP2M)		
	Channel	1	2	1	2
<b>Repeatability = Maximum artificial variation on diurnal time scale (peak-to-peak)</b>		4.3 Pa	1.4 Pa	6.5 Pa	2.5 Pa
<b>Absolute accuracy</b>		5.0 Pa	2.7 Pa	7.2 Pa	3.2 Pa
<b>Resolution (peak-to-peak)</b>		0.1 Pa	0.1 Pa	0.4 Pa	0.5 Pa
<b>Warm-up time</b>		6 min	8 min	2 s	2 s

565  
566 **Table 1:** DREAMS-P performances.

567

568 *3.1.3. MarsTEM*

569 At sensor level the calibration of MarsTEM has been done in a thermal bath, filled with liquid  
570 ethanol, with a stability of 0.03 K and by performing a comparison between the MarsTEM and a  
571 calibrated platinum RTD whose accuracy is better than 0.05 K in the foreseen operative range. The  
572 calibration is performed in the range -120°C...+40°C. The accuracy estimation includes other  
573 effects such as the Seebeck on in the junctions and soldering. Connecting wires between MarsTEM  
574 and CEU have been selected to have low Seebeck effect with platinum sensitive element.

575 A second step calibration was also performed at DREAMS level (both in vacuum and at 6 hPa  
576 between -120°C and +55°C) in order to take into account the effects due to the electrical resistance  
577 of the cables and their variation versus temperature.

578 Final accuracy and resolution for MarsTEM are 0.1 K and 0.02 K, respectively.

579 Self heating effect for the MarsTEM was considered at design level (Vidali et al., 2012). A  
580 mathematical model of MarsTEM representing the sensitive element (platinum wire) was developed  
581 and tested with several different ambient profiles in order to choose the wire diameter, the  
582 insulation thickness, the housing material. An electrical current profile was studied in order to  
583 reduce as much as possible the self-heating with a duty cycle of 23% (15ms ON - 50ms OFF) with a  
584 1mA current. The maximum increase in temperature observed was around 0.001K (after 80s) in a  
585 typical Martian-like environment (CO<sub>2</sub> atmosphere at 6 mbar). Sampling is set at 0.2 Hz.

586 A study was also performed in order to investigate and quantify the flow distortion due to the  
 587 presence of Schiaparelli lander (MarsTEM is accommodated at about 200 mm from the deck) and  
 588 MetMast shape and the temperature perturbation due to the buoyant thermal plume from the lander  
 589 itself. The complete results of the thermal and Computational Fluid Dynamics (CFD) of the lander  
 590 can be found in Chiodini et al. (2014).  
 591 Results of the simulation are displayed in Figure 9, where the difference in temperature measured at  
 592 the MarsTEM locations versus the incoming fluid temperature, for different wind velocities and a  
 593 deck temperature of 231.5 K are shown. Thermal plume in low wind conditions led to a circulation  
 594 around the lander, which modifies wind direction and speed around the lander.

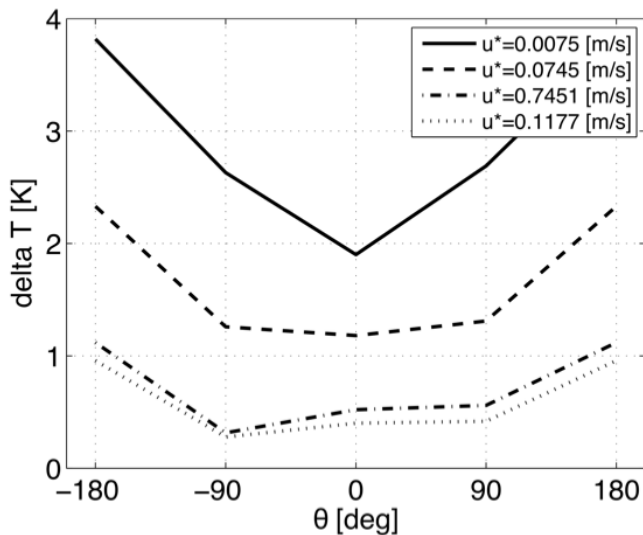

595  
 596 **Figure 9:** Difference between flow temperature at MarsTEM location and free stream.  $u^*$  is the  
 597 friction speed corresponding respectively to 0.1, 1, 10 and 15 m/s incoming wind velocities.  
 598

599 The experimental verification of the flow distortion has been performed at the Martian Wind Tunnel  
 600 in Aarhus (Holstein-Rathlou et al., 2014). These results will be presented in a separate paper.

601  
 602 *3.1.4. MetWind*

603 The MetWind calibration included the following steps:

- 604 1. Resistance vs Temperature calibration  
 605 2. Wind tunnel calibration:

- 606 ○ Measurement of sensor output as function of wind angle (Oxford Mars wind tunnel)
- 607 ○ Measurement of sensor output in varying wind speeds (Oxford Mars wind tunnel)
- 608 ○ Measurement of the shadowing effects by the MetMast (Aarhus Mars wind tunnel)

#### 609 *Resistance vs Temperature calibration*

610 MetWind sensor was subjected to a thermal soak in the temperature range of  $-77^{\circ}\text{C}$  to  $+127^{\circ}\text{C}$ .

611 A linear fit of the form  $R(T) = R_{\text{ref}} * (1 + \alpha (T - T_{\text{ref}}))$  was found to describe the temperature  
612 dependence of resistance of each of the three platinum films.  $R$  is the film resistance,  $T$  is  
613 temperature,  $R_{\text{ref}}$  and  $T_{\text{ref}}$  are respectively the resistance and temperature of the PTR sensor  
614 (Rosemount MF0118 PRT500) used as reference,  $\alpha$  is a calibration parameter.

#### 615 *Wind Tunnel Calibration*

616 The first two tests were carried out in Oxford's Low Density Wind Tunnel facility described in  
617 Wilson et al. (2008). The MetWind sensor was placed inside the wind tunnel on the axis of a  
618 stepper motor, allowing it to be rotated around its axis of symmetry to simulate different wind  
619 directions. All tests were conducted in air at room temperature and at 6 mbar pressure. Scaling to  
620 Mars conditions is achieved by using scaling laws with non-dimensional parameters: Reynolds  
621 number  $Re$  for wind speed and Nusselt number  $Nu$  for heat transfer. Discussion of the validation of  
622 the calibration approach, demonstrating the effectiveness of the scaling laws for different gases and  
623 varying pressures, is discussed by Wilson (2003b). Measurements were performed both in 'TEMP'  
624 and 'WIND' modes with the sensor placed at different angles with respect to the wind direction and  
625 at different wind speeds (including no wind). Measurements were obtained by averaging  
626 measurements acquired while rotating the sensor from  $0^{\circ}$  to  $360^{\circ}$  and vice versa in order to correct  
627 for any hysteresis associated with lag in the response of the sensor to changing wind direction.  
628 Sample results for the MetWind flight model are shown in Figure 10.

629

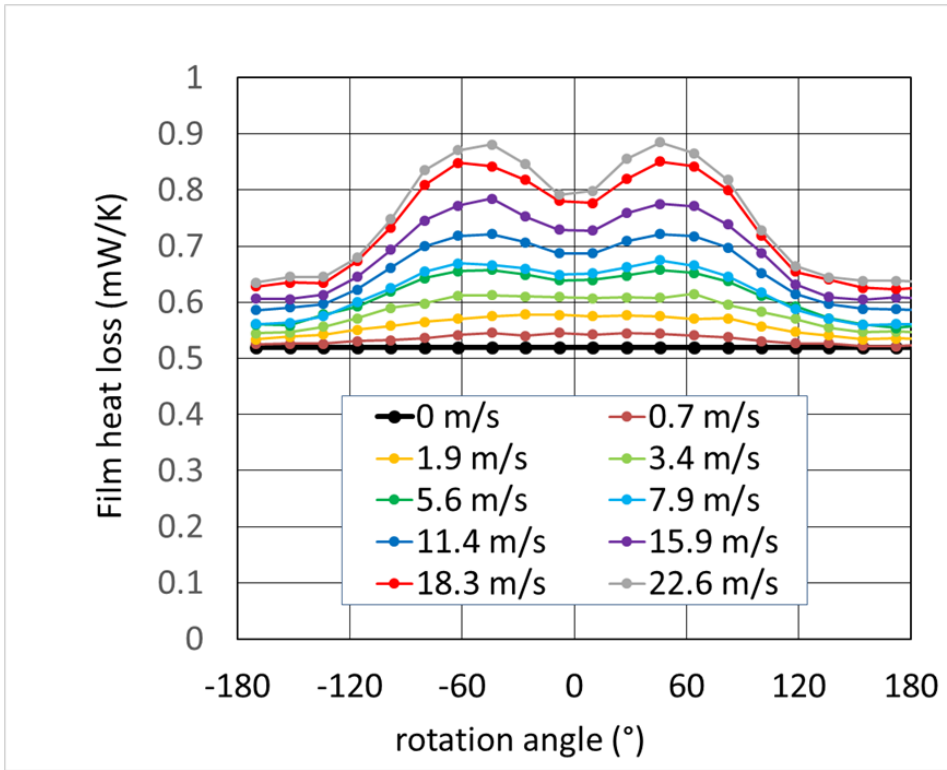

630

631 **Figure 10:** Calibration data for one of the MetWind Flight Model sensor films. The y-axis shows  
 632 the film's heat transfer coefficient, defined as [power dissipation / (film temperature – air  
 633 temperature)]. Rotation Angle denotes wind direction, with 0° signifying that film 1 is pointing  
 634 directly into the wind. Velocities have been scaled to show equivalent velocities in carbon dioxide  
 635 at a temperature of 250 K and a pressure of 6 mbar.

636

637 Each curve shows data for one of the three films (averaged results from one clockwise and counter-  
 638 clockwise rotations). The y axis expresses sensor performance as a heat transfer coefficient  $C_{film} =$   
 639  $q_{film} / (T_{film} - T_{air})$ , where  $q_{film}$  and  $T_{film}$  represent respectively the heat dissipation (in mW) and  
 640 temperature (in K) of the hot film.

641 The convective part of the heat loss from each film is calculated simply by subtracting the heat flow  
 642 experienced when no wind is present  $C_{conv} = C_{total} - C_{(u=0)}$ . This convective heat transfer coefficient  
 643 is then converted to a dimensionless Nusselt number  $Nu = Cd/Ak$ , where  $d$  and  $A$  represent the  
 644 diameter and area of the film, and  $k$  represents the thermal conductivity of the atmosphere. Finally,  
 645 the baseline data analysis method uses the differences between the films to calculate wind speeds.

646 From this we calculate an effective Nusselt vector ( $Nu_x, Nu_y$ ) from which a 2D wind vector is then  
647 calculated as described in Wilson 2003b.

648 The possible shadowing of MetWind by the full assembled MetMast structure was investigated in  
649 the Aarhus Martian wind tunnel in Aarhus. Results will be reported in a separate paper.

650 The calibration of the MetWind sensor is prone to some of the same issues common to all thermal  
651 anemometers: the films respond not just to changes in wind speed but to all thermal loads.

652 Uncertainties in the exact thermal environment around the MetWind sensor on Mars, due for  
653 example to changing temperatures of lander structure near MetWind, would have resulted in  
654 significant uncertainties in the absolute calibration of MetWind. If one side of the wind sensor was  
655 heated by proximity to a hot portion of the lander, for example, that would produce the same  
656 response in MetWind as a wind blowing toward that direction; such asymmetrical thermal loads  
657 could cause errors of up to 4 m/s in the measured wind vector in extreme cases, and up to 1 m/s in  
658 nominal cases. Ultrasonic time-of-flight wind sensors, as used for turbulence study on Earth, would  
659 provide a more robust calibration and faster response time (10 Hz compared to 0.2 – 0.5 Hz for  
660 MetWind). But MetWind proved well suited for the DREAMS goals of providing a basic landing  
661 site climatology and first-order turbulence characterization in an extremely compact and robust  
662 form.

663

### 664 3.1.5. *MicroARES*

665 Given that MicroARES measures the potential of its electrode, the electric field values are derived  
666 from finite element modelling of the antenna and lander immersed in an atmosphere of conductivity  
667  $\sigma_{atm}$ . The model discretises the generalized Ohm law, volume charge conservation and first Maxwell  
668 law equations (  $\vec{E} = \sigma_{atm} \cdot \vec{J}$  ;  $\partial\rho/\partial t + \vec{\nabla} \cdot \vec{J} = 0$  ;  $\vec{\nabla} \cdot \vec{E} = -\Delta V = \rho/\epsilon_0$  ) in order to properly  
669 simulate both the electric field deformations around the instrument and the resulting current collected  
670 by the electrode. The parasitic input values of the instrument (detailed below) are included in the

671 simulation. Typical model outputs are shown in Figure 11.

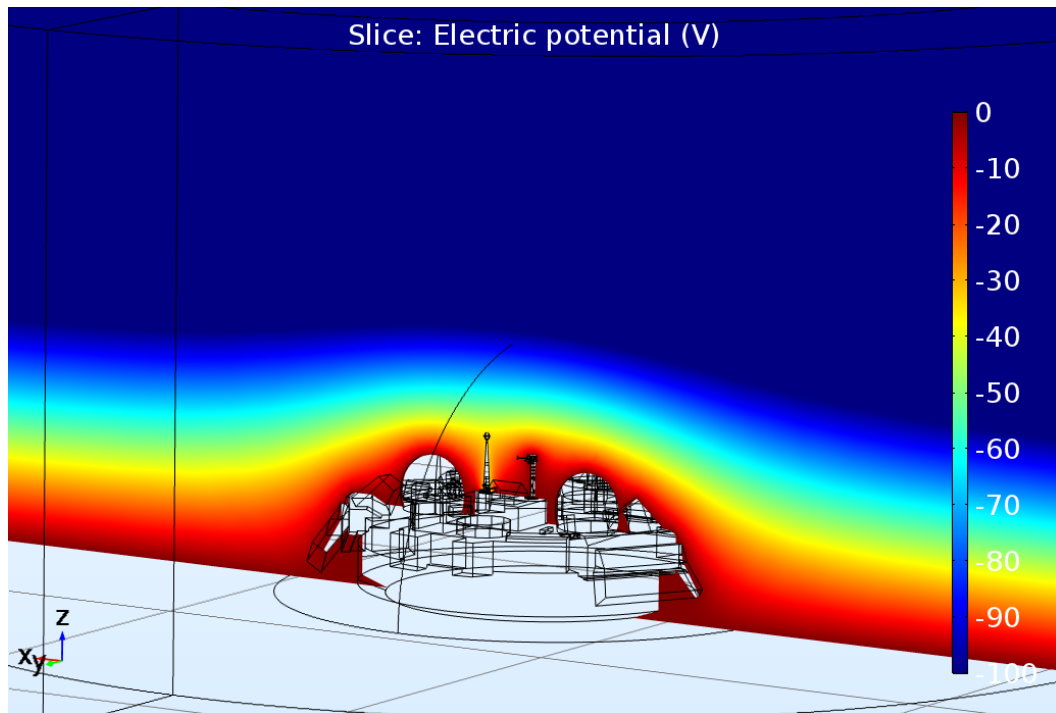

672

673 **Figure 11:** Electric field (-100V/m vertically constant) perturbations induced by the lander. The  
674 atmospheric conductivity is 2 pS/m and the resulting electrode potential measured by Micro-ARES is  
675 ~33.96V. The simulations are performed with the finite-element computation software COMSOL.

676

677 In the calibration process (Déprez, 2016), signals are always injected in the instrument through so-  
678 called *injection* boxes supposed to reproduce the coupling of the electrode with the atmosphere  
679 (Bertheliet al., 2000). These boxes consist of a set of resistances and capacitors mounted in parallel  
680 and specified to have resistance and capacitance values close to conditions relevant for the Micro-  
681 ARES electrode when immersed in a Martian-like atmosphere.

682 To calibrate the various components of the instrument part, potential is measured at various test points  
683 and the necessary relations (linearity, gain or frequency response) are subsequently established. The  
684 measurement uncertainties are given in the datasheets of the various devices. However, when the test  
685 point of the instrument measurement is used (in Least Significant Bits, LSB) the value and error are  
686 respectively derived from the average and standard deviation of a measurement set. The uncertainties  
687 are then propagated by fitting the data with adequate functions, using the least-square method to take  
688 into account the uncertainties of all inputs.



689

### 690 *DC Channel*

691 The DC chain was calibrated during Thermal vacuum tests, with temperatures ranging from 45°C to  
692 -35°C (every 5°C). The DC linearity at each temperature with each Injection box and at 17 steps was  
693 measured between -80V and +80V.

694 The electronic chain is described by equation (Millman theorem) shown below, which is fitted with  
695 data gathered during the TVT using the least-square method, in order to properly propagate the  
696 uncertainties:

$$697 \quad V_{injected}(LSB, T, Re) = V_{mes}(LSB, T) \cdot \left(1 + \frac{Re}{Ri(T)}\right) - i_L(T) \cdot Re$$
$$698 \quad Ri(T) = p_4 + p_5 \cdot T$$
$$699 \quad i_L(T) = p_6 \cdot \exp(p_7 \cdot T)$$

700 The resulting error on the computed electrode potential at 20°C is shown in Figure 12.

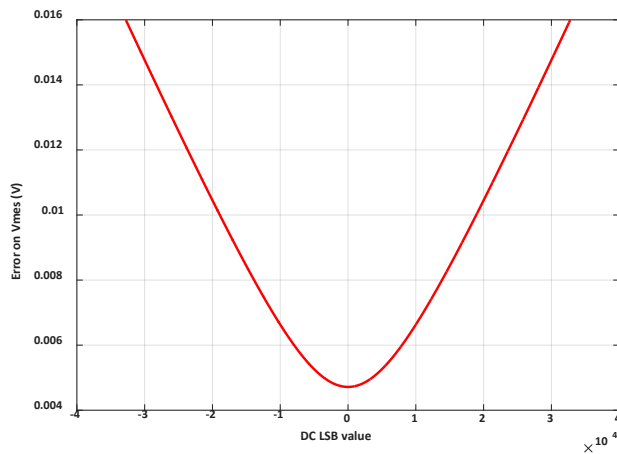

701

702 **Figure 12:** Error on the retrieved electrode potential at 20°C

703

### 704 *AC Channel*

705 The AC channel calibration has been performed only at 20°C, since the noise conditions and access  
706 to the instrument board during the TVT was limited.

707 Calibration consisted in measuring the frequency response, both in gain and phase, of the whole  
708 electronic circuit (Figure 13).

709

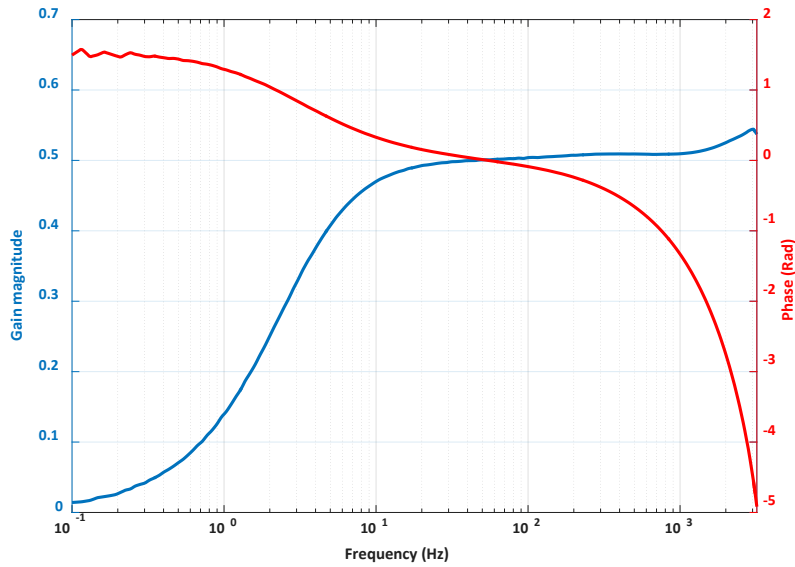

**Figure 13:** AC channel response in gain and phase

710

711

712

713

#### 714 3.1.6. SIS

715

716

717

718

719

720

721

722

723

724

725

726

727

728

The calibration of SIS photodetectors consists of various steps. The first step is aimed at determining the responsivity to light normally incident to each detector. Then the variation of this response as the angle of incidence of light varies is measured to calibrate the angular response of each detector. Finally, the thermal dependence of the responsivity is measured, although the thermal effects were found to be very small.

The facilities used for this calibration are at INTA's SPASOLAB (Space Solar Cell Test Laboratory, an official laboratory for solar cells testing according to ESA required standards). SPASOLAB has several sun simulators and Xenon lamps. A triple light source Sun simulator set to AM0 (Air Mass 0, i.e. outside the atmosphere) spectrum and a set of neutral filters are used for the normal-incidence responsivity calibration. For the angular dependence, SIS OH is mounted on a rotating mechanism controlled by two high-precision (0.01° step) motors that allows the relative azimuth and zenith angle between OH and the light source direction to be controlled. The thermal calibration is done in a thermal chamber with an optical quartz window. The accuracy of the lamp irradiance is known within  $\pm 1\%$ .

729 The dynamic range of the 3 different spectral channels is  $1050 \text{ W/m}^2$  for the unfiltered (zenith-  
730 pointing) detector,  $390 \text{ W/m}^2$  for the NIR detectors, and  $110 \text{ W/m}^2$  for the UV ones. The  
731 responsivities are  $0.544 \mu\text{A}/(\text{W/m}^2)$  for the unfiltered, around  $1.38 \mu\text{A}/(\text{W/m}^2)$  for the NIR detectors  
732 (with slight differences between them), and  $0.202 \mu\text{A}/(\text{W/m}^2)$  for UV, with minor differences  
733 between the 3 UV detectors. The uncertainty (standard deviation) in the determination of these  
734 values ranges from 0.17% to 0.41%, depending on the detector.

735 For the calibration of the angular dependence, the main source of uncertainty was due to the set-up  
736 itself. An error in the knowledge of the real angle of incidence of light of up to 0.5 degrees is  
737 assumed. This leads to errors in the accuracy of the angular dependence calibration of less than 5%  
738 for  $\pm 30$  degrees from the normal incidence. These errors rise up to 20% in the limit of the FoV,  
739 where the responsivity is less than 5% of that at normal incidence. Details can be found in Jiménez  
740 et al. (2016).

741 Thermal effects are small on SIS measurements, and become negligible after applying corrective  
742 factors as a function of the internal PT1000 sensor installed inside the OH.

743 Finally, it is worth mentioning the small angular dependence of the unfiltered, zenith-pointed,  
744 detector. Its angular dependence shows revolution symmetry when varying azimuth, and regarding  
745 zenith angle, the responsivity is still higher than 90% of the normal incidence one for 35 degrees. It  
746 is still 80% of the normal incidence responsivity for a zenith angle of 50 degrees, whereas the total  
747 average responsivity is 81% of that for normal incidence, when its complete hemispherical FoV is  
748 considered. Thanks to this, to convert the measured photocurrent (A) into irradiance ( $\text{W/m}^2$ ), a  
749 direct application of the normal incidence responsivity value is possible, with acceptable error,  
750 regardless of the particular Sun position. Specially, if the Sun is in a low relative zenith angle, the  
751 direct, circumsolar, and most of the diffuse light will actually be received with a responsivity very  
752 close to the nominal (normal incidence) value, making the estimation of the absolute irradiance a  
753 very straightforward process. Figure 14, extracted from Jiménez et al. (2016), shows this angular  
754 dependence:

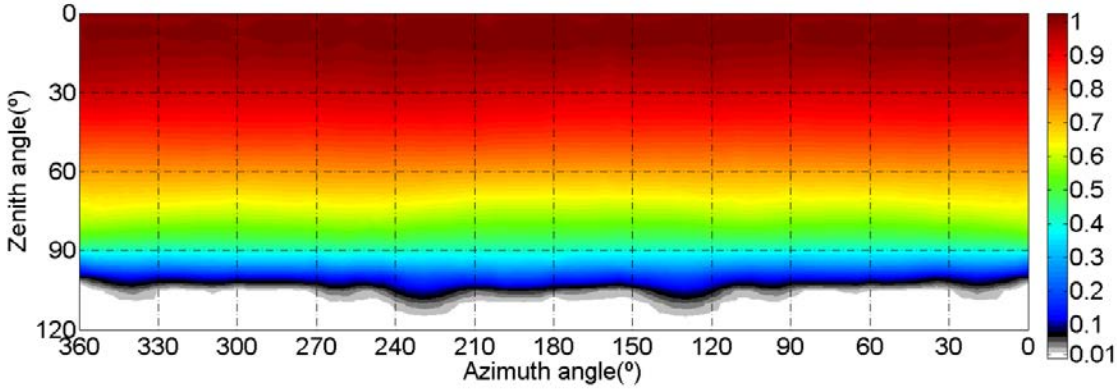

755  
756 **Figure 14:** Angular dependence of the zenith-pointing SIS detector responsivity.

757  
758 The performances of all SIS detectors are summarized in Table 2. During the trip to Mars, the  
759 accumulated radiation will degrade the detectors' responsivity in a different amount for each  
760 spectral band. Radiation analysis shows that the maximum signal degradation for the expected  
761 radiation levels (margins accounted) is 14% (for the NIR sensor which is the worst case). This can  
762 then be reduced thanks to the estimation of the Displacement Damage suffered by the detectors,  
763 obtained through the monitoring of the dark-current of the reference detector included for this  
764 purpose.

	Incident light angle	Noise, expressed as equivalent irradiance	Accuracy*		Precision	
			Value	Unit	Value	Unit
TOP	@ Normal incidence	$1.1 \cdot 10^{-3}$	1	%	0.04	%
	@ 50% of the FoV	$2.2 \cdot 10^{-3}$	3	%	0.1	%
	Under diffuse light	$1.4 \cdot 10^{-3}$	1	%	0.003	W/m <sup>2</sup>
NIR	@ Normal incident	$0.4 \cdot 10^{-3}$	1	%	0.004	%
	@ 50% of the FoV	$0.8 \cdot 10^{-3}$	6	%	0.08	%
	@ 10% of the FoV	$4 \cdot 10^{-3}$	10	%	0.4	%
UV	Under diffuse light	$0.5 \cdot 10^{-3}$	1	%	0.005	W/m <sup>2</sup>
	@ Normal incident	$0.1 \cdot 10^{-3}$	2	%	0.04	%
	@ 50% of the FoV	$0.2 \cdot 10^{-3}$	7	%	0.1	%
	@ 10% of the FoV	$1 \cdot 10^{-3}$	10	%	0.4	%
	Under diffuse light	$0.12 \cdot 10^{-3}$	1	%	0.001	W/m <sup>2</sup>

765 \* It is supposed a solar position accuracy of 1 deg

766 **Table 2:** SIS performances as computed from calibration. Note: It must not be surprising that the  
767 indicated values in the table, even the noise, depend on the angle of incidence of the light. This is  
768 because the different magnitudes have been expressed as an equivalent irradiance. But to translate,  
769 for example, a noise, into irradiance, the sensor's calibration equation must be used. This equation  
770 includes an important parameter which is the Angular Response Function of the sensor, that  
771 depends on the angle of incidence of the light. For that reason the "equivalent irradiance" of that  
772 noise depends on the angle we may suppose in a hypothetical scenario.

773

774 The calibration of the accelerometer inside the PE was done using precision motors and precision  
775 bubbles to fix the horizontal position for each axes. First the real orientation of each axis with  
776 regard to the PE box was found, and then rotations around the axis were applied in order to find the  
777 offset and sensitivity of each accelerometer. Only X and Y axes were acquired, allowing for a  
778 complete determination of the tilt angle of the XY plane after landing, and rotation of the X and Y  
779 axis within that plane. Different analysis were carried out to find the uncertainty that could be  
780 introduced by thermal effects and by the uncertainty in the knowledge of the gravity of Mars (which  
781 affects the calculation of the XY rotation within its plane). It was found that the required  
782 uncertainties in the temperature and gravity knowledge, needed to create a tilt uncertainty of 1°,  
783 were around 12°C and 1.5 m/s<sup>2</sup> respectively. The thermal effects were however calibrated by using  
784 a thermal chamber and some fixed inclinations provided by special support tools. The knowledge of  
785 gravity is better than ±0.05 m/s<sup>2</sup>.

786 The acquisition scheme of SIS makes use of an oversampling acquisition that provided around 20  
787 bits of free-of-noise effective resolution for the photodetecting channels, as measured during the  
788 calibration campaign.

789 Finally, it is worth noting that, in a long-duration mission, dust deposition on the detectors surfaces  
790 will be the main source of degradation of the total responsivity. The use of magnets around the  
791 photodetectors, to slightly deflect the dust trajectory and thus minimize its deposition rate, was  
792 proposed for the Rover Environmental Monitoring Station (REMS) on Curiosity (Michael D. Smith  
793 et al., 2016). The same is being done in the Radiation and Dust Sensor (RDS) of MEDA, the next-  
794 generation meteorological station that INTA develops for the Mars2020 Rover (V. Apéstigue et al.,  
795 2015). Also, the responsivity degradation can be roughly estimated through the analysis of the  
796 yearly evolution of all the sensors lying in the same plane (a number of sensors, all of them showing  
797 similar long-term signal decrease), as experienced in REMS.

798 Nevertheless, for all scientific retrieval algorithms for which relative instead of absolute signals are  
799 employed (i.e. the ratio between the signals delivered by detectors in different sides of the optical  
800 head), an in-situ calibration process is proposed. It is worth noting that the estimation of the optical  
801 depth can be done by means of these purely differential measurements. The method consists in  
802 comparing the signals provided by each couple of detectors when the Sun lies in a symmetric  
803 position with regard to their FoVs. In the absence of degradation, each detector should generate the  
804 same signal (within their initial differences in responsivity). This technique also allows, during the  
805 first Sols of a mission (when dust deposition is still negligible) to determine the orientation of the  
806 sensor after landing, as was demonstrated during the field campaign carried out in the Sahara desert  
807 (I. Arruego et al, 2017).

808

### 809 3.1.7. DREAMS performances

810 The performances of DREAMS sensors are summarized in Table 3.

Sensor	Measured Quantity	Range	Resolution	Accuracy
<b>MarsTEM</b>	Temperature	70 – 320 K	0.02 K	0.1 K
<b>DREAMS-P</b>	Pressure	0-1015 hPa	< 0.5 Pa	< 5 Pa (BOL) (*)
<b>DREAMS-H</b>	Relative humidity	0-100%	0.5 % RH	±10% RH down to -70°C ±20% RH down to -83°C +/-4% RH in dry conditions at all T
<b>MetWind</b>	Wind speed Wind direction	0.3 – 30 m/s and above	0.1 m/s	+/- 1 m/s +/- 10° for wind speeds >5 m/s
<b>MicroARES</b>	Vertical Electric Field and potential	<i>DC channel</i> -256 to +256 V/m in native mode > 10 kV/m in HV mode, depending on the atmospheric conductivity  <i>AC channel</i>	<i>DC channel</i> 8 mV/m in native mode ~0.1 V/m in HV mode, depending on the atmospheric conductivity  <i>AC channel</i>	<i>DC channel</i> 60 mV/m in native mode. ~1.2V/m in HV mode.  <i>AC channel</i>

		4-3200 Hz frequency range	0.26, 0.52 and 25Hz spectral resolution in the respective 4-50, 50-100 and 100- 3200Hz bands.	
		15 V/m peak-to- peak in standard mode.	0.2 mV/m in standard mode.	0.15 mV/m in standard mode.
		0.2 V/m peak-to- peak in high sensitivity mode.	3 $\mu$ V/m in high sensitivity mode.	2 $\mu$ V/m in high sensitivity mode.
<b>SIS</b>	Solar Irradiance	<i>Under direct normal light:</i> Tot: 220-1200 nm: 0-1050 W/m <sup>2</sup>	<i>Under direct normal light:</i> TOP: 1 mW/m <sup>2</sup>	<i>Depends on the angle of incidence of the light:</i> Tot. irradi.: 1-30% (30% for SZA>85 deg)
	Dust opacity	NIR: 700-1100 nm: 0-390 W/m <sup>2</sup>	NIR: 0.4 mW/m <sup>2</sup>	NIR: 1-10%
	UV intensity	UVA: 315-400 nm: 0-110 W/m <sup>2</sup>	UV: 0.1 mW/m <sup>2</sup>	UV: 1-10%

811 **Table 3:** Performances of the DREAMS sensors. (\*) The reported value of the accuracy of the  
812 pressure sensor refers to channel 2 of both DREAMS-P1 and DREAMS-P2 sensors (see Sect.  
813 3.1.2).

814

### 815 3.2. In-flight performances

816 During the trip to Mars all the DREAMS sensors were activated for calibration and health check  
817 tests. Sensors have been activated for three nominal and two additional checkouts between April  
818 and September 2016. All sensors performed nominally.

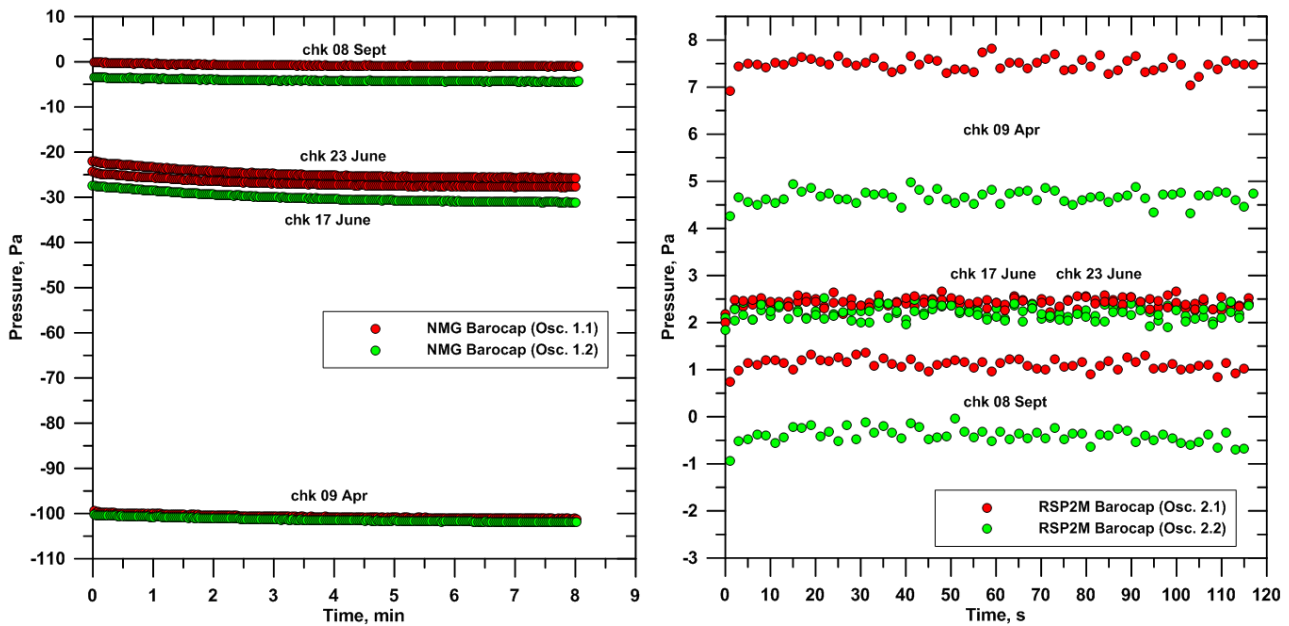

819

820 **Figure 15:** DREAMS-P pressure reading during the cruise checkouts on 9<sup>th</sup> April, 17<sup>th</sup> and 23<sup>rd</sup>  
 821 June and 8<sup>th</sup> September, respectively. Readings from channel 1 of each pressure sensor are  
 822 represented in red, while green indicates data from channel 2. P1 sensor (left plot) shows untypical  
 823 behaviour going from -100 Pa reading at the first checkout to about 0 Pa in September. Note that P1  
 824 sensor has no space flight heritage. P2 sensor behavior is as expected.

825

826 During the cruise, Schiaparelli was encapsulated inside the spacecraft rear and front shields.

827 Vacuum and dry conditions were expected inside the spacecraft. Thus, the readings from

828 DREAMS-P and DREAMS-H have been used to correct on-ground calibration for the natural

829 drifting of sensors and other effects. Figure 15 shows the trend of P1 and P2 sensors readings

830 during the various checkouts. As expected, both sensors experienced outgassing during the cruise.

831 The trend of P1 sensor resulted untypical but both sensors resulted completely outgassed and with

832 reading of few Pa about one month before the landing.

833 DREAMS-H offset was also measured during all the checkouts.

834 In the last checkout before landing phase it was between -2.4% and -1.5% depending on Humicap

835 sensor (Figure 16).



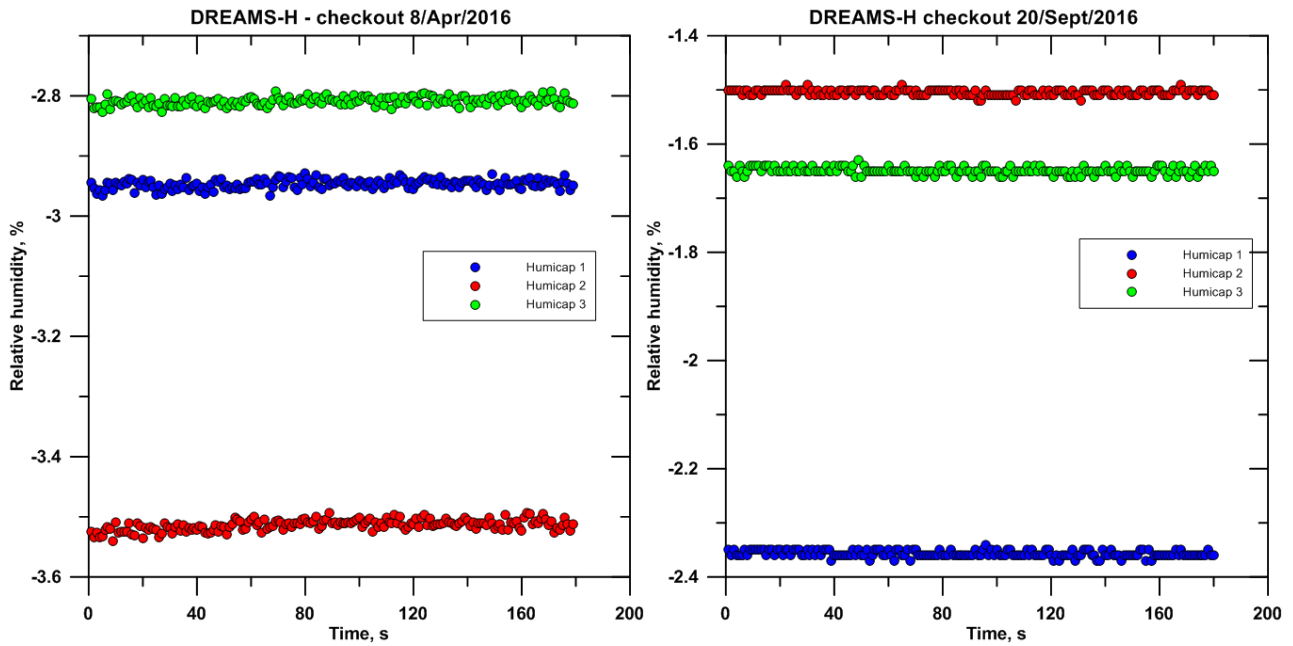

836

837 **Figure 16:** DREAMS-H reading during the first (left) and last (right) checkout.

838

839 MarsTEM behavior was nominal (Figure 17).

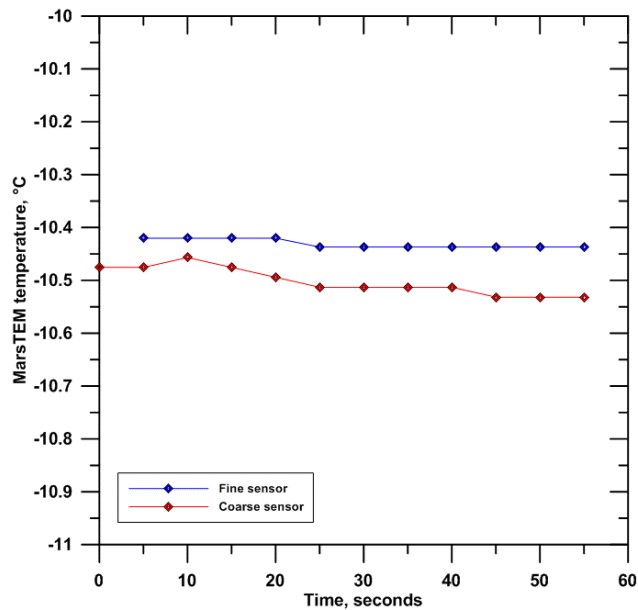

840

841 **Figure 17:** MarsTEM signal as acquired during the June checkout.

842

843 MetWind was turned on several times during cruise. Figure 18 shows the evolution of film

844 temperatures during the last in-cruise check-out, on September 2016. The plot shows the

845 temperatures of the hot films and of the housekeeping temperature sensor located in the centre of

846 the MetWind sensor, as described in Section 2.4. During the first 30 seconds, the sensor was in its  
 847 low power mode where only  $\sim 2$  mW are dissipated in the films. After 30 seconds MetWind was  
 848 switched into its wind sensing mode, where  $\sim 40$  mW are dissipated in the films, to check the  
 849 correct functioning of its electronics. This high power mode was used only for ten seconds to avoid  
 850 overheating of the films, a condition which can arise in the vacuum of space when the films are not  
 851 convectively cooled. The behavior of the wind sensor in these tests was nominal.

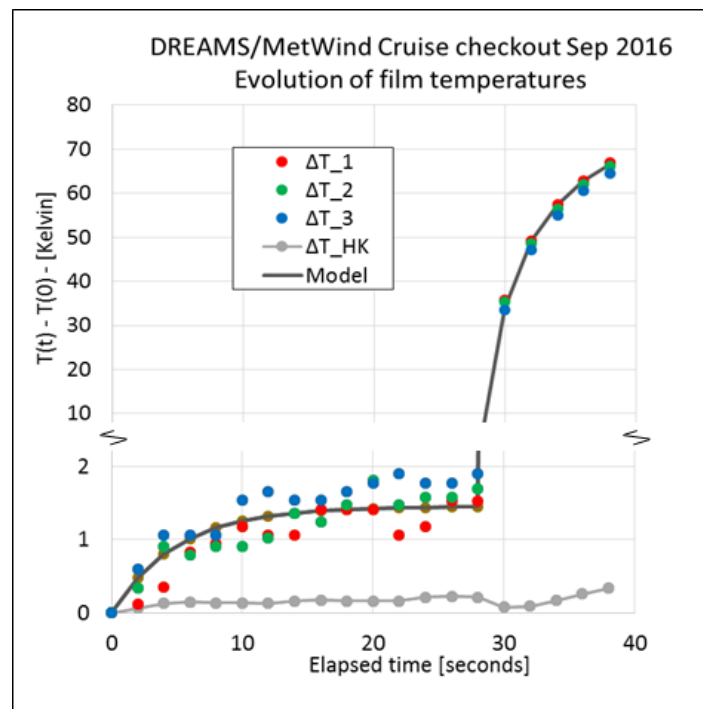

852  
 853 **Figure 18:** MetWind film temperatures during the last in-flight checkout, in Sep 2016. Heating  
 854 power in the films was  $\sim 2$  mW for the first 30 seconds, 40 mW for the subsequent 10 seconds. Note  
 855 the discontinuity in the vertical scale.  $\Delta T_{HK}$  refers to a housekeeping temperature, measured at  
 856 the centre of the MetWind sensor.

857  
 858 MicroARES health check produced also expected results in terms of housekeeping values and  
 859 sensor behavior.  
 860 SIS confirmed the excellent quality of the signals. Figure 19 shows some of the telemetry acquired  
 861 during the last activation before reaching Mars.

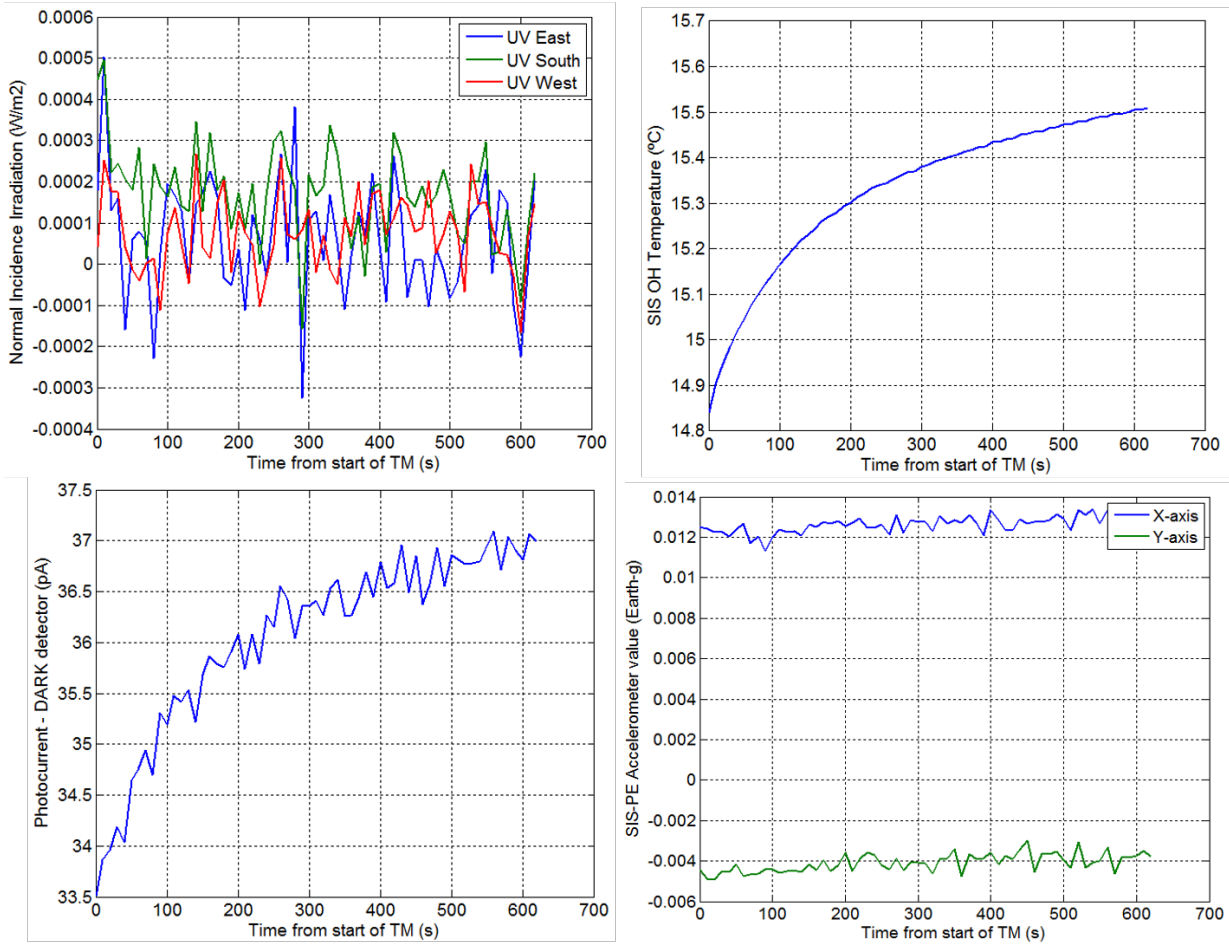

862

863 **Figure 19:** Some telemetry from the SIS activation on September 21<sup>st</sup>. From top to bottom and left  
 864 to right: signals from the UV detectors expressed as the equivalent normal-incidence irradiance that  
 865 would be necessary to generate the measured photocurrents, OH temperature, Dark current of the  
 866 reference dark detector, and accelerometers signals.

867

868 As it can be seen, the noise in the UV photodetectors show a standard deviation equivalent (when  
 869 converted to irradiance) to around  $0.1 \text{ mW/m}^2$ , which compared to the  $110 \text{ W/m}^2$  dynamic range  
 870 equals  $0.9 \cdot 10^{-6}$  (i.e. more than 20 bits of free-of-noise resolution). The noisiest channel, due to the  
 871 high gain employed in the current-to-voltage conversion, was the dark-current one. For this channel,  
 872 the requirement was to measure from pA to almost 40nA (which would be equivalent to more than  
 873 15 bits of free-of-noise resolution). The telemetry shows that the pA resolution was actually  
 874 achieved.

875

876 The DREAMS in-flight data are archived into the European Space Agency's Planetary Science  
877 Archive (Schipani et al., 2016). The archive adopts the NASA's Planetary Data System version 4  
878 (PDS4) standards as a baseline for the formatting and structure of all data.

879

880 **4. Test in the Sahara desert**

881 DREAMS was fabricated to land on Mars during the dust storm season. For this reason, the  
882 instrument has been designed to cope with a dusty environment. The landing during the dust storm  
883 season would also provide a great opportunity to study, for the first time, the effect of dust on the  
884 electric properties of the Martian atmosphere.

885 Field experiments have been performed in the Sahara desert in 2013 and 2014, during the dust storm  
886 season, to test sensor response to harsh environment and study the relation between the emission of  
887 dust and the electric properties of the atmosphere. The results of these tests are a good start point to  
888 understand the dusty environment of Mars from future DREAMS acquired data.



889  
890 **Figure 20:** Meteorological station deployed in the Sahara desert for the study of dust lifting process  
891 and its feedback on the electrical properties of the atmosphere.

892  
893 The scientific goal of the field campaign was the study of the development and evolution of dust  
894 storms and dust devils. For this aim, a meteorological station (see Figure 20), particularly devoted to  
895 the monitoring of sand saltation process (the bouncing of sand grains above the soil when blown by  
896 the wind) and dust entrainment in the atmosphere, has been deployed in the region around Merzouga

897 (Errachidia) in the Moroccan desert. This desert has a Martian-like terrain and offers a good chance  
898 to understand the physics behind aeolian processes. The chosen area is particularly rich in both sand  
899 and dust particles and it is very active from the aeolian point of view.

900 The following physical quantities have been monitored for six months during the Summers 2013 and  
901 2014: wind speed and direction at six different altitudes (wind vertical profile), atmospheric humidity,  
902 temperature at two heights, pressure, solar irradiance, soil moisture and temperature, sand saltation  
903 rate (by detecting the impacts of sand particles over two impact sensors), atmospheric electric field  
904 (Campbell CS110) and the size distribution and number density of dust grains entering into the  
905 atmosphere. The goal was to correlate environmental parameters to sand movements and dust  
906 entrainment and, in particular, verify the effect of sand saltation process on the  
907 generation/enhancement of the atmospheric electric field. Data analysis shows that charging of grains  
908 during aeolian processes produces an enhancement of the atmospheric electric field. E-fields up to 20  
909 kV/m have been observed during the most intense dust storms. Note that the fair weather field is of  
910 the order of 50-100 V/m. The field intensity results to be linearly related to the number of lifted grains  
911 and negatively correlated with relative humidity. Moreover, data indicate that strong E-fields are also  
912 capable to enhance dust lifting in a feedback process. A detailed discussion of campaign results is  
913 reported in Esposito et al. (2016). Similar data could be collected by DREAMS instrument on Mars.  
914 During July 2014, some of the DREAMS sensors, MicroARES, MarsTEM and SIS, were added to  
915 the meteorological station deployed in the desert (Figure 21). The goal was to test their behavior  
916 during dusty events.

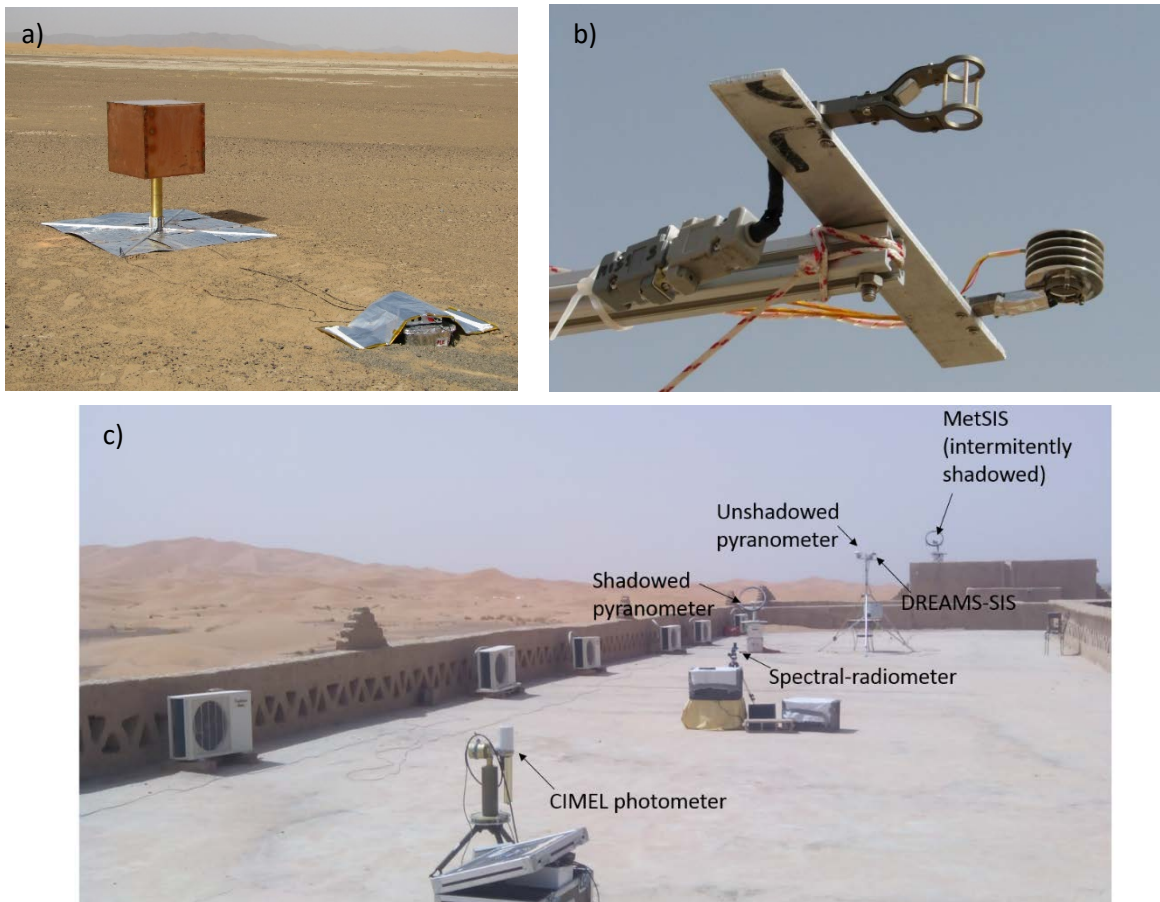

917

918 **Figure 21:** DREAMS sensors added to the meteorological station deployed in the Moroccan desert:  
 919 a) Terrestrial version of MicroARES; b) At the top: the MarsTEM temperature sensor without the  
 920 radiation shield; on the bottom right: the MarsTEM sensor protected by the aluminium shield; on  
 921 top, fixed to the shield, the PT100 B sensor and in the shadow of the shield the PT100 A, directly  
 922 exposed to air; c) SIS and other devices.

923

924 We used a terrestrial version of MicroARES antenna that was larger than the original one (Figure 21  
 925 a). This was due to the different electric conductivity on Earth and Mars. For atmospheric  
 926 conductivity roughly 100 times smaller than that of Mars, an electrode roughly 100 times larger is  
 927 needed in order to keep the sheath resistance  $R_s$  at the same order of magnitude. A greater  $R_s$  would  
 928 cause the electrode not to be able to maintain itself at the floating local potential because of the small  
 929 bias current flow to the input amplifier. The terrestrial model was a 60 cm side copper cube. Its 2.16  
 930  $m^2$  surface area was equivalent to a 41.6 cm radius sphere, around 30 times larger than the original  
 931 antenna. For more details see Harrison et al. (2016).

932 Given the fact that the Campbell CS110 electric field mill mounted on the meteorological station can  
933 only measure electric field signals with a frequency below 0.5Hz, only the DC data can be compared  
934 to MicroARES sensor. However, the two instruments were located 50 meters apart, with a setup at 2  
935 meters from the ground for the CS110, and a setup at 50 cm from the ground for MicroARES.  
936 Therefore, a meaningful comparison can only remain at a qualitative level.

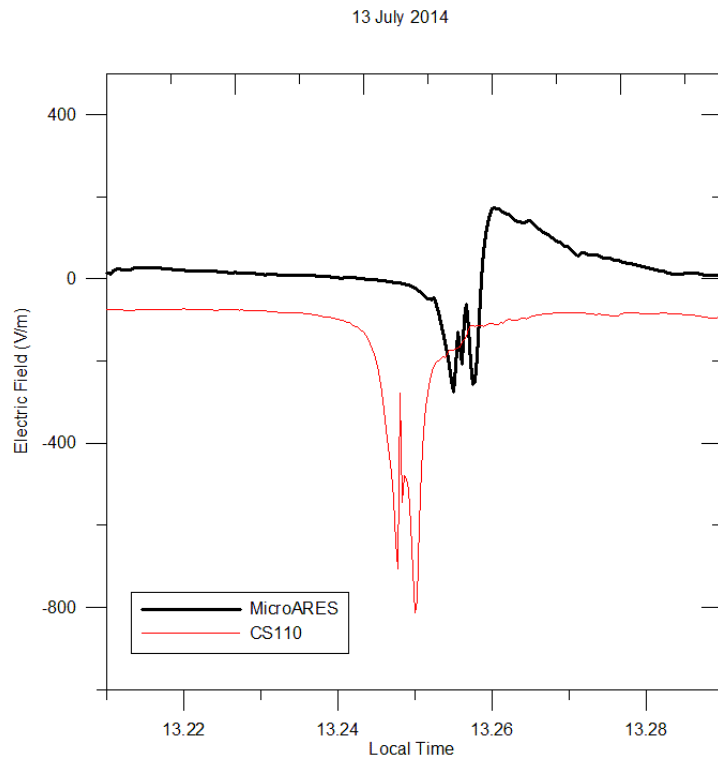

937  
938 **Figure 22:** Dust-devil cross detection by CS110 electric field mill and Micro-ARES.

939  
940 The ability of Micro-ARES to provide interesting data is confirmed by the concomitant dust devil  
941 detection made by the two instruments on many occasions (one example is shown in Figure 22).

942 The signatures of the dust devil exhibit expected differences but overall provide excellent  
943 agreement with regard to the shape and timing of the sudden electric field rises and demises.

944  
945 Two prototypes of the MarsTEM sensor were tested and compared during three days of  
946 measurements: a Titanium sensor structure with an aluminium shield and a free-shield sensor with a  
947 more complex structure made with Titanium alloy and peek rods (Figure 21 b). Several reference



948 sensors (PT100) were positioned on the upper and lower part of the shield for comparison. During  
949 the testing the weather was variable, clouds were observed both in daytime and in night-time, wind  
950 changed both in velocity and direction and relative humidity changed in the range (0 ...+50%). Some  
951 rainy events occurred lasting around half an hour, and some very weak dust storms were detected by  
952 the instruments. Temperature data were sampled at a 1 Hz frequency.

953 Daytime data showed clearly that the aluminium shield heated up and the temperature measured by  
954 the MarsTEM sensor was affected by a non negligible bias. For this reason, and because of similar  
955 effect foreseen by an ad hoc developed simulation using a CFD code in a Martian environment (see  
956 Chiodini et al. 2015), it was decided to not equip the MarsTEM with the aluminium protecting shield.  
957 During the nights, measurements were conducted continuously and data registered on the data logger;  
958 several peculiar events were observed and analysed (see Colombatti et al 2015). Evidence of a strong  
959 correlation of temperature, wind (both for velocity and direction), humidity and topography was  
960 highlighted.

961

962 A test campaign was also carried out with SIS (Figure 21 c). Different procedures for estimating  
963 the atmospheric optical depth (OD) were applied. One of them is based on fitting the measured  
964 photocurrents to the expected ones according to simulations made with radiative transfer models  
965 for different atmospheric conditions. The second, is based on the same fitting but working with  
966 signals (and model estimations) normalized to their own maximum, i.e., paying attention to the  
967 shape of the signals but not to their absolute values (thus rendering negligible any possible dust  
968 accumulation effect). The last procedure compares the photocurrents generated, at each moment,  
969 by the one of the three equal lateral detectors that has the Sun inside its FoV, and the sum of the  
970 two others. In other words, it compares global (direct plus diffuse) and diffuse light. The three  
971 procedures are detailed in Arruego et al. (2017), whereas the radiative-transfer model employed to  
972 simulate the SIS signals is described in Toledo et al. (2017). From the set of OD estimations  
973 obtained with the three different methods outlined, and with the different lateral detectors (a fitting

974 between each detector's signal and the model, was done), the standard deviation of the estimations  
975 was found to be less than 18%.

976 Regarding the absolute irradiance measured with the zenith-pointing detector, it was compared to  
977 that provided by a set of two pyranometers (un-shadowed one for global light measurement, and  
978 shadowed one for diffuse light measurement). The difference between the two estimations (SIS and  
979 pyranometers) was well below 10% for solar zenith angles (SZA) as high as 50° (Arruego et al.,  
980 2017).

981

982 All tests confirm that DREAMS sensors perform nominally in harsh environment and are absolutely  
983 well suited for the monitoring of environmental parameters during dust events.

984

985

## 986 **5. Operations**

### 987 *Surface operation timeline*

988 DREAMS lifetime is limited by the capacity of its power unit and the power profile during  
989 operations. The acquisition sequence was designed as a compromise among scientific goals,  
990 available energy and communication constraints due to the sequence of orbiters passages over the  
991 landing site.

992 In order to cope with the science goals, measurements sequence has been built in order to:

- 993 • Be almost periodic all along the day and night time. This allows to monitor the diurnal cycle  
994 of atmospheric parameters.
- 995 • Make them more frequent in the daytime and longer at midday. Indeed, the Martian climate  
996 database (<http://www-mars.lmd.jussieu.fr/>) predicts a peak in surface temperature around  
997 13:00 Mars local true solar time (LTST) in the landing site and period (Bertrand et al.,  
998 2016). Most of the convective activity, like high-frequency fluctuations of atmospheric

999 wind, temperature, pressure, is expected roughly between 11:00 and 15:00. This is the most  
1000 favorable period to get stronger winds and dust events (devils, storms).

- 1001 • Have a long duration measurement at twilight in order to capture the highest relative  
1002 humidity of the night (at sunset) and study cloud properties.

1003 To fulfill the scientific objectives DREAMS is able to control each sensor independently, setting the  
1004 start and stop time of each acquisition sequence, the acquisition rate and other parameters needed to  
1005 configure the internal sensors (namely Sensor SWitch sequence: SSW). The unit is able to store in  
1006 its non-volatile memory six different operation timelines. Each timeline is a list of SSW sequences  
1007 to be executed in different phases of the mission. Two fail-safe mission timelines are hard-coded in  
1008 the application software and cannot be changed, while the other four timelines are used for the  
1009 nominal mission and can be uploaded to the unit during the interplanetary cruise to Mars. One of  
1010 them is used to support the in-flight checkout operations. The other three timelines are used to  
1011 implement the surface phase of the mission, they are called MTL1, MTL2 and MTL3 for  
1012 convenience. Each timeline covers the acquisitions foreseen during one Martian sol starting from  
1013 the local midnight. The acquisition sequences are triggered with respect to the Mars LTST  
1014 computed at the center of the landing ellipse. In this way the acquisitions are correlated with the  
1015 local events e.g. sunrise, sunset and specific part of the sol.

1016 DREAMS is designed to operate autonomously once on the Mars surface. After the touch-down the  
1017 descent module powers-on DREAMS, provides the mission time to the unit and then sets DREAMS  
1018 in surface mode. Once in surface mode DREAMS starts executing the MTL1, then MTL2 and  
1019 MTL3. At the beginning of the fourth sol DREAMS will execute again the stored MTLs starting  
1020 from MTL1 and so on until the depletion of its internal battery. Acquired data is stored in the non-  
1021 volatile memory of the unit waiting for the upload to the descent module. To save energy both  
1022 DREAMS and the descent module are able to enter a low-power mode. The two units are kept  
1023 synchronized with their internal timers and wake-up simultaneously. At each wake-up DREAMS

1024 uploads data to the descent module, then the descent module uploads data to the orbiters, notifies to  
1025 DREAMS the time of the next communication window and enters hibernation again.

1026 The design and validation of the three surface mission timelines is a crucial step for the success of  
1027 the mission. These timelines are designed to satisfy several conditions listed below:

- 1028 • Guarantee at least 2 sols of operation
- 1029 • Max energy consumption of 120 Wh with 5% margin at the last data upload
- 1030 • Acquisition and storage of at least 50 Mbit of data for each sol
- 1031 • Guarantee that DREAMS is ready to wake-up when expected by the descent module (with  
1032 no more than 500 ms of margin)
- 1033 • Guarantee that during the communication with the descent module, MicroARES is off to  
1034 avoid disturbing the UHF link with the orbiters.

1035 The final timeline is then tested simulating a two sols mission on the DREAMS Flight Spare model.

1036 The final surface mission timelines uploaded to DREAMS are depicted in Figure 23. The touch  
1037 down was expected on 2016-10-19 at 14:48:17. Some seconds after the touch down the

1038 initialization of the DREAMS takes place and the first hibernation cycle begins. The first SSW to  
1039 be executed is the SSW #19 of the MTL #1 (first sol of operation). The nominal mission foresees

1040 the execution of 43 SSWs listed in Table 3. These SSW correspond to about 11 hours and 20

1041 minutes of data acquisition over 51 hours and 48 minutes of operation (see green markers in Figure

1042 23). During each SSW all the sensors are acquired simultaneously with different configurations

1043 depending on the local time. The overall data volume uploaded to the descent module is about 118

1044 Mbit over 2 sols. The internal battery depletion was expected around 2016-10-21 at 18:50:00.

1045 Nevertheless, the MTLs contains additional SSWs (gray markers) that could be executed in an

1046 extended mission. The energy stored in the battery depends on the thermal conditions experienced

1047 by the instrument during the cruise and at the surface, hence a warmer environment could result in

1048 more energy available for the experiment.

1049

MTL	SSW	UTC	Local time	Time [s]	Data [Mbit]
1	19	20161019T15:12:20.000	13:40:00.808	1528	6.559
	20	20161019T15:53:27.000	14:20:00.773	1530	6.616
	21	20161019T17:10:32.000	15:35:00.100	1117	3.097
	22	20161019T17:41:23.000	16:05:00.803	406	1.057
	23	20161019T18:07:04.000	16:29:59.930	762	2.178
	24	20161019T18:48:11.000	17:09:59.895	406	1.057
	25	20161019T19:31:22.000	17:52:00.489	2182	5.527
	26	20161019T20:25:51.000	18:45:00.660	393	0.211
	27	20161019T22:13:47.000	20:30:00.686	393	0.163
	28	20161020T00:17:08.000	22:30:00.574	393	0.163
2	1	20161020T02:20:30.000	00:30:01.432	393	0.171
	2	20161020T04:23:51.000	02:30:01.316	393	0.163
	3	20161020T05:56:21.000	04:00:00.497	395	0.325
	4	20161020T06:58:02.000	05:00:00.923	393	0.211
	5	20161020T07:28:52.000	05:30:00.650	2905	7.470
	6	20161020T08:56:15.000	06:55:01.171	393	0.211
	7	20161020T09:47:38.000	07:45:00.390	393	0.171
	8	20161020T10:13:20.000	08:10:00.485	735	0.382
	9	20161020T10:44:11.000	08:40:01.184	393	0.171
	10	20161020T11:15:01.000	09:10:00.909	393	0.171
	11	20161020T11:45:51.000	09:40:00.635	393	0.171
	12	20161020T12:06:25.000	10:00:01.100	767	2.455
	13	20161020T12:42:23.000	10:35:00.455	408	1.195
	14	20161020T13:08:05.000	11:00:00.550	767	2.455
	15	20161020T13:44:04.000	11:35:00.877	408	1.195
	16	20161020T14:09:46.000	12:00:00.972	767	2.455
	17	20161020T14:40:36.000	12:30:00.696	1552	7.559
	18	20161020T15:11:26.000	13:00:00.421	1552	7.559
	19	20161020T15:42:17.000	13:30:01.118	1552	7.559
	20	20161020T16:18:15.000	14:05:00.471	1127	3.633
	21	20161020T17:40:29.000	15:25:00.383	1127	3.633
	22	20161020T18:06:11.000	15:50:00.477	1127	3.633
	23	20161020T18:47:18.000	16:30:00.432	769	2.544
	24	20161020T19:18:08.000	17:00:00.155	408	1.244
	25	20161020T20:11:36.000	17:52:00.972	2096	0.813
	26	20161020T20:57:51.000	18:37:00.556	408	1.195
	27	20161020T21:42:03.000	19:20:00.483	408	1.195
3	1	20161021T04:02:23.000	01:30:00.290	407	1.130
	2	20161021T08:03:57.000	05:25:00.367	2892	6.958
	3	20161021T15:20:49.000	12:29:59.946	1484	4.527
	4	20161021T15:51:40.000	13:00:00.636	1484	4.527
	5	20161021T17:49:52.000	14:54:59.875	1546	7.315
	6	20161021T18:20:43.000	15:25:00.565	1546	7.315
<b>Tot.</b>				<b>40891</b>	<b>118</b>

1053  
 1054  
 1055  
 1056  
 1057  
 1058  
 1059  
 1060  
 1061  
 1062  
 1063  
 1064  
 1065  
 1066  
 1067  
 1068  
 1069  
 1070  
 1071  
 1072  
 1073  
 1074  
 1075

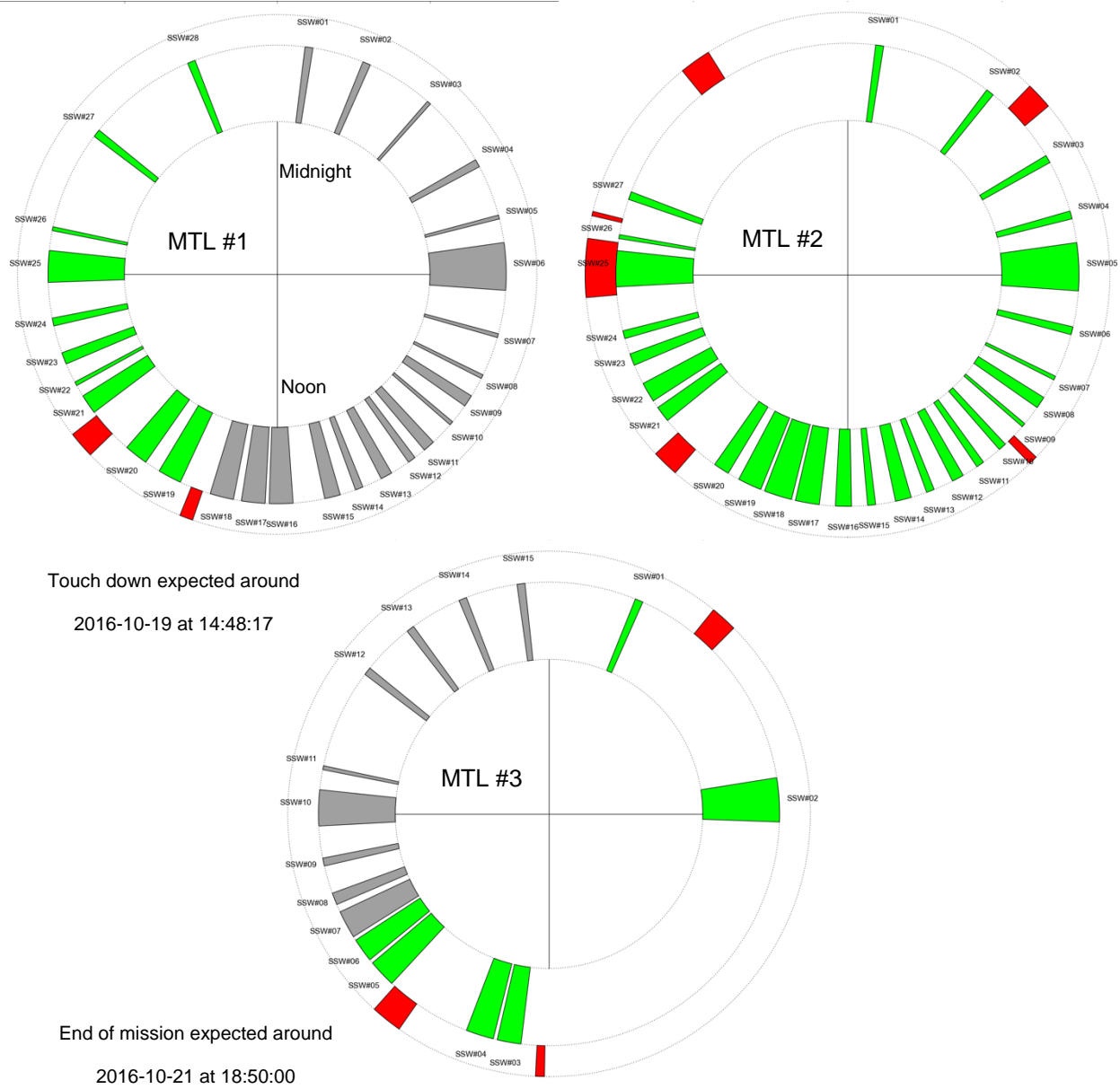

**Figure 23:** Final surface timeline. Gray markers are the sensor acquisitions not executed, green are executed, while red markers are the communication windows with the descent module.

1076 **6. Conclusions**

1077 The Schiaparelli module of the ExoMars 2016 mission accommodated the DREAMS (Dust  
1078 Characterization, Risk Assessment and Environmental Analyzer on the Martian Surface) experiment.

1079 DREAMS is a small meteorological station with the capability to measure electrical fields at the  
1080 Martian surface. It includes six sensors: MarsTEM (thermometer), MetWind (anemometer),  
1081 DREAMS-P (pressure sensor), DREAMS-H (humidity sensor), SIS (Solar Irradiance Sensor) and  
1082 MicroARES (electric field sensor), a Common Electronic Unit and a Battery. It can operate  
1083 autonomously according to a Mission Time Line and provide environmental measurements at the  
1084 surface of Mars, including the first ever investigation of atmospheric electric phenomena. It can be  
1085 accommodated on any short or long duration platform on the Martian surface.

1086 DREAMS is an autonomous instrument suite with an internal power supply unit. It has been designed  
1087 to survive and operate in extremely dusty conditions. Its overall mass is 4362 g including the battery  
1088 (1691 g) and the harness. Its power consumption at the nominal battery voltage of 28V is 5.60 W  
1089 when in Cruise and Surface states, 7.84 W during acquisition, 6.72 W in Upload state and 0.28 W in  
1090 idle state. DREAMS has been fully calibrated and tested in the field. It performed nominally during  
1091 the cruise to Mars and was healthy during the descent to Mars. A Spare Model of the instrument,  
1092 identical to the one flown on-board Schiaparelli is available for a future mission.

1093

1094 **Appendix**

1095 **List of acronyms**

<b>AC</b>	Alternating Current
<b>ADC</b>	Analog to Digital Converter
<b>AM0</b>	Air Mass 0
<b>CEU</b>	Central Electronic Unit
<b>CFD</b>	Computational Fluid Dynamics
<b>COTS</b>	Commercial-Of-The-Shelf
<b>CPU</b>	Central Processing Unit
<b>DC</b>	Direct Current
<b>DREAMS</b>	Dust characterization, Risk assessment and Environment Analyzer on the Martian Surface
<b>DSP</b>	Digital Signal Processor
<b>EDM</b>	Entry descent and landing Demonstrator Module
<b>E-field</b>	Electric field
<b>ESA</b>	European Space Agency
<b>FM</b>	Flight Model
<b>FMI</b>	Finnish Meteorological Institute
<b>FoV</b>	Field of View
<b>FPGA</b>	Field-Programmable Gate Array
<b>FS</b>	Flight Spare
<b>HK</b>	Housekeeping
<b>INTA</b>	Instituto Nacional de Técnica Aeroespacial
<b>ISO</b>	International Standards Organization
<b>LTST</b>	Local True Solar Time
<b>MCU</b>	Microcontroller Unit
<b>MEMS</b>	Micro Electro-Mechanical System
<b>MSL</b>	Mars Science Laboratory
<b>MTL</b>	Mission TimeLine
<b>NASA</b>	National Aeronautics and Space Administration
<b>NIR</b>	Near Infrared
<b>OBDH</b>	On-Board Data Handling
<b>OD</b>	Optical Depth
<b>OH</b>	Optical Head



<b>P1/P2</b>	DREAMS Pressure Sensor 1/2
<b>PCB</b>	Printed Circuit Board
<b>PDS4</b>	Planetary Data System version 4
<b>PE</b>	Processing Electronics
<b>PTFE</b>	Polytetrafluoroethylene
<b>RDS</b>	Radiation and Dust Sensor
<b>REF</b>	Ground reference model
<b>REMS</b>	Rover Environmental Monitoring Station
<b>RH</b>	Relative Humidity
<b>RTD</b>	Resistance Temperature Detector
<b>SIS</b>	Solar Irradiance Sensor
<b>SNR</b>	Signal to Noise Ratio
<b>SPASOLAB</b>	Space Solar Cell Test Laboratory
<b>SSW</b>	Sensor SWitch sequence
<b>SZA</b>	Solar Zenith Angle
<b>TID</b>	Total ionizing Dose
<b>TGO</b>	Trace Gas Orbiter
<b>TVT</b>	Thermal Vacuum Test
<b>UHF</b>	Ultra High Frequency
<b>UTC</b>	Universal Time Coordinated
<b>UV</b>	UltraViolet

1097 **Acknowledgments**

1098 This work was supported by the Italian Space Agency through the agreement I/018/12/0:  
1099 “DREAMS EDM Payload ExoMars 2016.” The development of the DREAMS instrument was  
1100 funded and coordinated by ASI.  
1101 DREAMS is the result of a cooperation of six European Countries (Italy, France, Spain,  
1102 Netherlands, Finland, United Kingdom) led by Italy. DREAMS is built by UPD-CISAS with  
1103 contribution from LATMOS/FMI/INTA/Oxford University/INAF-OAC, operated by INAF-  
1104 OAC/UPD-CISAS and provided by ASI.

1105

1106 **References**

1107 Álvarez M., C. Hernando, J. J. Jiménez, F. J. Álvarez, I. Martín and D. Escribano, TID results of  
1108 optical materials and photodiodes for SIS instruments (DREAMS project), in *Proc. of IEEE*  
1109 *Nuclear and Space Radiation Effects Conference*, Paris, France (2014).  
1110 Álvarez M., J. J. Jiménez, D. Escribano, P. Manzano, I. Arruego, V. Apéstigue, M. González-  
1111 Guerrero, Low Dose Rate TID testing of ADXL327 Accelerometer for a Mars Mission, in *Proc.*  
1112 *of IEEE Nuclear and Space Radiation Effects Conference*, Boston, Massachusetts (2015).  
1113 Apéstigue V., I. Arruego, J. Martínez, J.J. Jiménez, J. Rivas, M. González, J. Álvarez, J. Azcue, A.  
1114 Martín-Ortega, J.R. de Mingo, M. T. Álvarez, L. Bastide, A. Carretero, A. Santiago, I. Martín, B.  
1115 Martín, M.A. Alcacera, J. Manzano, T. Belenger, R. López, D. Escribano, P. Manzano, J.  
1116 Boland, E. Cordoba, A. Sánchez-Lavega, S. Pérez, A. Sainz López, M. Lemmon, M. Smith, C.  
1117 E. Newman, J. Gómez Elvira, N. Bridges, P. Conrad (7), M. de la Torre Juárez, R. Urqui, J.A.  
1118 Rodríguez Manfredi. Radiation and Dust Sensor for MARS2020: technical design and  
1119 development status overview, in *Proc. of European Planetary Science Congress*, Vol 10. (2015)

1120

1121

1122 Aplin K.L., Atmospheric electrification in the Solar System, *Surveys in Geophysics*, 27, 1, 63-108  
1123 (2006). doi: 10.1007/s10712-005-0642-9.

1124 Arruego I., V. Apéstigue, J. Jiménez-Martín, J. Martínez-Oter, F.J. Álvarez-Ríos, M. González-  
1125 Guerrero, J. Rivas, J. Azcue, I. Martín, D. Toledo, L. Gómez, M. Jiménez-Michavila, M. Yela,  
1126 DREAMS-SIS: the Solar Irradiance Sensor on-board the ExoMars 2016 Lander, submitted for  
1127 publication to *Advances in Space Research*, (2016).

1128 Arruego I., V. Apéstigue, J. Jiménez-Martín, J. Martínez-Oter, F.J. Álvarez-Ríos, M. González-  
1129 Guerrero, J. Rivas, J. Azcue, I. Martín, D. Toledo, L. Gómez, M. Jiménez-Michavila, M. Yela,  
1130 DREAMS-SIS: the Solar Irradiance Sensor on-board the ExoMars 2016 Lander, *Advances in*  
1131 *Space Research* 60 (2016) 103-120.

1132 Atreya S.K., Wong A.-S., Renno N. O., Farrell W. M., Delory G.T., Sentman D.D., Cummer, S.A.,  
1133 Marshall J.R., Rafkin S.C. R., Catling D.C., Oxidant Enhancement in Martian Dust Devils and  
1134 Storms: Implications for Life and Habitability, *Astrobiology*, Vol. 6, Iss. 3, pp. 439-450 (2006).

1135 Bertrand T., A. Spiga, S. Rafkin, A. Colaitis, F. Forget, E. Millour, An intercomparison of Large-  
1136 Eddy Simulations of the Martian daytime convective boundary layer, *Geosci. Model Dev.*  
1137 *Discuss.*, doi:10.5194/gmd-2016-241 (2016).

1138 Berthelier, J., Grard, R., Laakso, H., Parrot, M., ARES, atmospheric relaxation and electric field  
1139 sensor, the electric field experiment on NETLANDER. *Planetary and Space Science* 48, 1193–  
1140 1200 (2000). doi:10.1016/S0032-0633(00)00103-3

1141 Chiodini S., G. Colombatti, M. Pertile, S. Debei, Numerical study of lander effects on DREAMS  
1142 scientific package measurements, *IEEE Metrology for Aerospace (MetroAeroSpace)*, 433-438  
1143 (2014).

1144 Chiodini S., G. Colombatti, E. Friso, M. Pertile, S. Debei, “Multiphysics modelling of MarsTEM  
1145 shield,” in 2015 *IEEE Metrology for Aerospace (MetroAeroSpace)*, pp. 271– 276 (2015).

1146 Chojnacki M., Urso A., Fenton L.K., Michaels T.I., Aeolian dune sediment flux heterogeneity in  
1147 Meridiani Planum, Mars, Aeolian Research (2016) in press.

1148 Colombatti G., S. Chiodini, E. Friso, A. Aboudan, C. Bettanini, S. Debei, F. Esposito, “MarsTEM:  
1149 The temperature sensor of the DREAMS package onboard Exomars2016,” in *2014 IEEE*  
1150 *Metrology for Aerospace (MetroAeroSpace)*, pp. 249–254 (2014).

1151 Colombatti G., S. Chiodini, E. Friso, A. Aboudan, C. Bettanini, M. Poli, S. Debei, F. Esposito, C.  
1152 Molfese, P. Schipani, R. Mugnuolo, S. Pirrotta, E. Marchetti, MARSTEM FIELD TEST IN  
1153 MARS ANALOG ENVIRONMENT, in *2015 IEEE Metrology for Aerospace (MetroAeroSpace)*,  
1154 2015).

1155 Déprez G., Micro-ARES on ExoMars 2016, PhD thesis, to be published (2016).

1156 Esposito F., R. Molinaro, C. I. Popa, C. Molfese, F. Cozzolino, L. Marty, K. Taj-Eddine, G. Di  
1157 Achille, G. Franzese, S. Silvestro, and G. G. Ori., The role of the atmospheric electric field in the  
1158 dust-lifting process, *Geophys. Res. Lett.*, 43 (2016). doi:10.1002/2016GL068463.

1159 Farrell, W.M., McLain, J.L., Collier, M.R., Keller, J.W., Jackson, T.J., Delory, G.T., Is the electron  
1160 avalanche process in a martian dust devil self-quenching? *Icarus* 254, 333–337 (2015).  
1161 doi:10.1016/j.icarus.2015.04.003

1162 Formisano, V., Atreya, S., Encrenaz, T., Ignatiev, N., Giuranna, M., Detection of Methane in the  
1163 Atmosphere of Mars, *Science*, 306, Iss. 5702, pp. 1758-1761 (2004).

1164 Harri, A.-M., M. Genzer, O. Kempainen, H. Kahnäpää, J. Gomez-Elvira, J.A. Rodriguez-Manfredi,  
1165 R. Haberle, J. Polkko, W. Schmidt, H. Savijärvi, J. Kauhanen, E. Atlaskin, M. Richardson, T.  
1166 Siili, M. Paton, M. de La TorreJuarez, C. Newman, S. Rafkin, M.T. Lemmon, M. Mischna, S.  
1167 Merikallio, H. Haukka, J. Martin-Torres, M.-P. Zorzano, V. Peinado, R. Urqui, A. Lepinette, A.  
1168 Scodary, T. Mäkinen, L. Vazquez, N. Rennó, and the REMS/MSL Science Team, Pressure  
1169 observations by the Curiosity rover – Initial results, *J. Geophys. Res.* 119, 82-92 (2014a).

1170 Harri, A.-M., M. Genzer, O. Kempainen, J. Gomez-Elvira, R. Haberle, J. Polkko, H. Savijärvi, N.  
1171 Rennó, J.A. Rodriguez-Manfredi, W. Schmidt, M. Richardson, T. Siili, M. Paton, M. de la Torre-

1172 Juarez, T. Mäkinen, C. Newman, S. Rafkin, M. Mischna, S. Merikallio, H. Haukka, J. Martin-  
1173 Torres, M. Komu, M.-P. Zorzano, V. Peinado, L. Vazquez, and R. Urqui, Mars Science  
1174 Laboratory Relative Humidity Observations – Initial results, *J. Geophys. Res.* 119, 2132-2147  
1175 (2014b).

1176 Harrison R.G., E. Barth, F. Esposito, J. Merrison, F. Montmessin, K.L. Aplin, C. Borlina, J.J.  
1177 Berthelier, G. Déprez, W. Farrell, I.M.P. Houghton, N.O. Renno, K.A. Nicoll, S.N. Tripathi, M.  
1178 Zimmerman, Applications of electrified dust and dust devil electrodynamics to Martian  
1179 atmospheric electricity, *Space Science Review* (2016), doi: 10.1007/s11214-016-0241-8.

1180 Holstein-Rathlou C., J. Merrison, J. J. Iversen, A. B. Jakobsen, R. Nicolajsen, P. Nørnberg, K.  
1181 Rasmussen, A. Merlone, G. Lopardo, T. Hudson, D. Banfield, and G. Portyankina, An  
1182 Environmental Wind Tunnel Facility for Testing Meteorological Sensor Systems, *Journal of*  
1183 *Atmospheric and Oceanic Technology*, vol. 31, issue 2, pp. 447-457 (2014).

1184 Jimenez J.J., Oter J.M., Apestigue V., Hernando C., Ibarria S., Hajdas W., Sanchez-Paramo J.,  
1185 Alvarez M.T., Arruego I., Guerrero H., Proton Monitor Las Dos Torres: First Intercomparison of  
1186 In-Orbit Results, *IEEE Transactions on Nuclear Science*, Vol. 59, No. 4 (2012).

1187 Jiménez J. J., F.J Álvarez, M. Gonzalez-Guerrero, V. Apéstigue, I. Martín, J. M Fernández, A. A.  
1188 Fernán, I. Arruego, Calibration OGSE for a Multichannel Radiometer for Mars Atmosphere  
1189 Studies, in *Proc. of International Conference on Space Optics, ICSO*, Biarritz, France (2016).

1190 Mumma, M.J., Villanueva, G.L., Novak, R.E., Hewagama, T., Bonev, B.P., DiSanti, M.A., Mandell,  
1191 A.M., Smith, M.D., Strong Release of Methane on Mars in Northern Summer 2003, *Science*,  
1192 Volume 323, Issue 5917, pp. 1041- (2009).

1193 Murphy J., K. Steakley, M. Balme, G. Deprez, F. Esposito, H. Kahanpää, M. Lemmon, R. Lorenz, N.  
1194 Murdoch, L. Neakrase, M. Patel, P. Whelley, Field Measurements of Terrestrial and Martian Dust  
1195 Devils, *Space Science Reviews* (2016). Doi: 10.1007/s11214-016-0283-y

1196 Nikkanen T., Schmidt W., Harri A.-M., Genzer M., Hieta M., Haukka H., Kemppinen O., Space

1197 qualification of an automotive microcontroller for the DREAMS-P/H pressure and humidity  
1198 instrument on board the ExoMars 2016 Schiaparelli lander, EPCS2015-465 (2015).

1199 Schipani, P., Marty, L., Mannelta, M., Esposito, F., Molfese, C., Aboudan, A., Apestigue-Palacio, V.,  
1200 Arruego-Rodríguez, I., Bettanini, C., Colombatti, G., Debei, S., Genzer, M., Harri, A.-M.,  
1201 Marchetti, E., Montmessin, F., Mugnuolo, R., Pirrotta, S., Wilson, C., The ExoMars DREAMS  
1202 scientific data archive, Proc. SPIE 9913, 99134F (2016).

1203 Seiff A., Tillman J.E., Murphy, J.R., Schofield J.T., Crisp, D., Barnes, J.R., LaBaw C., Mahoney  
1204 C., Mihalov J.D., Wilson G.R., Haberle R., The atmosphere structure and meteorology  
1205 instrument on the Mars Pathfinder lander, J. Geophys. Res., 102, Iss. E2, p. 4045-4056 (1997).

1206 Silvestro S., Vaz D.A., Fenton L.K., Geissler P.E., Active aeolian processes on Mars: A regional  
1207 study in Arabia and Meridiani Terra, Geophysical Research Letters, L20201 (2011).  
1208 doi:10.1029/2011GL048955.

1209 Silvestro S., Vaz D.A., Di Achille G., Popa I.C., Esposito F., Evidence for different episodes of  
1210 aeolian construction and a new type of wind streak in the 2016 ESA ExoMars landing ellipse in  
1211 Meridiani Planum, Mars, Journal of Geophysical Research: Planets, 120, Iss. 4, pp. 760–774  
1212 (2015). doi:10.1002/2014JE004756.

1213 Smith M.D., María-Paz Zorzano, Mark Lemmon, Javier Martín-Torres, Teresa Mendaza de Cal,  
1214 Aerosol optical depth as observed by the Mars Science Laboratory REMS UV photodiodes,  
1215 *Icarus* 280, 234–248 (2016).

1216 D. Toledo, I. Arruego, V. Apéstigue, J.J. Jiménez, L. Gómez, M. Yela, P. Rannou, J.-P.  
1217 Pommereau, “Measurement of dust optical depth using the solar irradiance sensor (SIS) onboard  
1218 the ExoMars 2016 EDM”, *Planetary and Space Science* 138 (2017) 33–43.

1219 Towner, M. C., Patel, M. R., Ringrose, T. J., Zarnecki, J. C., Pullan, D., Sims, M. R., Haapanala, S.,  
1220 Harri, A. M., Polkko, J., Wilson, C. F., Zent, A. P., Quinn, R. C., Grunthner, F. J., Hecht, M.  
1221 H., Garry, J. R. C., The Beagle 2 environmental sensors: science goals and instrument  
1222 description. *Plan. Space Sci.*, 52: 1141-1156 (2004).

1223 Vago, J., Witasse, O., Svedhem, H., Baglioni, P., Haldemann, A., Gianfiglio, G., Blancquaert, T.,  
1224 McCoy, D., de Groot, R., ESA ExoMars program: The next step in exploring Mars, Solar  
1225 System Research, Volume 49, Issue 7, pp.518-528 (2015).

1226 Vidali I., MarsTEM, un termometro per la misura della temperatura atmosferica marziana:  
1227 progettazione, prototipazione e studio degli effetti dovuti all' autoriscaldamento, Bachelor Thesis,  
1228 Padova Univ. (2012).

1229 Webster C.R., P.R. Mahaffy, S.K. Atreya, G.J. Flesch, M.A. Mischna, P.-Y. Meslin, K.A. Farley,  
1230 P.G. Conrad, L.E. Christensen, A.A. Pavlov, J.Martín-Torres, M.-P. Zorzano, T.H. McConnochie,  
1231 T. Owen, J.L. Eigenbrode, D.P. Glavin, A. Steele, C.A. Malespin, P. D. Archer Jr. B. Sutter, P.  
1232 Coll, C. Freissinet, C.P. McKay, J.E. Moores, S.P. Schwenzer, J.C. Bridges, R. Navarro-Gonzalez,  
1233 R. Gellert, M.T. Lemmon, the MSL Science Team, Mars methane detection and variability at Gale  
1234 crater, Science, 347, Iss. 6220, pp. 415-417 (2015).

1235 Wilson C. F., Calcutt S. B., Jones T. V., The Beagle 2 wind sensor, EGS - AGU - EUG Joint  
1236 Assembly, abstract #691 (2003).

1237 C.F. Wilson, Measurement of wind on the surface of Mars, DPhil thesis, 2003b.

1238 Wilson C.F., Camilletti A. L., Calcutt S. B., Ligrani P. M., A wind tunnel for the calibration of  
1239 Mars wind sensors, Planet. Space Sci., 56, Iss. 11, p. 1532-1541 (2008).  
1240 doi:10.1016/j.pss.2008.05.011