



**HAL**  
open science

## Combining a High-Level Design Tool for Safety-Critical Systems with a Tool for WCET Analysis on Executables

C Ferdinand, R Heckmann, T Le Sergent, D. Lopes, B Martin, X Fornari, F. Martin

### ► To cite this version:

C Ferdinand, R Heckmann, T Le Sergent, D. Lopes, B Martin, et al.. Combining a High-Level Design Tool for Safety-Critical Systems with a Tool for WCET Analysis on Executables. Embedded Real Time Software and Systems (ERTS2008), Jan 2008, toulouse, France. insu-02270107

**HAL Id: insu-02270107**

**<https://insu.hal.science/insu-02270107>**

Submitted on 23 Aug 2019

**HAL** is a multi-disciplinary open access archive for the deposit and dissemination of scientific research documents, whether they are published or not. The documents may come from teaching and research institutions in France or abroad, or from public or private research centers.

L'archive ouverte pluridisciplinaire **HAL**, est destinée au dépôt et à la diffusion de documents scientifiques de niveau recherche, publiés ou non, émanant des établissements d'enseignement et de recherche français ou étrangers, des laboratoires publics ou privés.

# Combining a High-Level Design Tool for Safety-Critical Systems with a Tool for WCET Analysis on Executables

C. Ferdinand,<sup>1</sup> R. Heckmann,<sup>1</sup> T. Le Sergent,<sup>2</sup> D. Lopes,<sup>2</sup> B. Martin,<sup>2</sup> X. Fornari,<sup>2</sup> F. Martin<sup>1</sup>

1: AbsInt Angewandte Informatik GmbH, Science Park 1, D-66123 Saarbrücken, Germany

2: Esterel Technologies, 9 rue Michel Labrousse, F-31100 Toulouse, France

**Abstract:** Synthesizing code from model-based software specifications using automatic code generators such as the SCADE Suite allows design verification at early project stages and helps to avoid coding errors, thus reducing the need for low-level testing. Non-functional properties of the implementation such as execution time and memory consumption require specific analysis. Static program analysis tools like AbsInt's StackAnalyzer and timing analyzer aiT complete ideally the model-based design process with the verification of these properties. These tools can also give SCADE users a direct feedback on the effects of their design decisions on resource usage, allowing them to select more efficient designs and implementation methods. The SCADE tool, StackAnalyzer and aiT can be integrated in a way that the analysis results for code generated by the SCADE tool are conveniently accessible from within the SCADE development environment. We present the tools and their integration, preliminary results, and plans for integration with other tools for timing analysis.

**Keywords:** Model-based code generation, timing analysis, stack-usage analysis

## 1. Introduction

Software developers in the avionics sector face some specific challenges: Many software systems are safety-critical and, thus, must achieve high quality objectives. Model-based design aims at satisfying the high safety requirements in combination with good development productivity by starting with a software specification. The implementation process is not necessarily automatic. It is therefore still possible to introduce software defects through misinterpretation of design and specification documents or through human error during the manual coding process. Automatic code generators such as the one provided by SCADE are increasingly used to generate the implementation from the specification. By creating C code directly from the model-based specification, these code generators avoid the typical translation problems that occur in the implementation stage. Moreover, as the SCADE Suite code generator, SCADE KCG, is qual-

ified as a development tool w.r.t. DO-178B level A, unit testing on the generated code can be avoided.

Many design and implementation errors are avoided by synthesizing code from specifications. However, non-functional properties such as absence of memory overflow and timer overruns are still an issue. To verify such properties of the implementation, unit tests and runtime measurements are currently widely used in the industry. These approaches have some limitations:

- To acquire a high level of confidence to have detected the worst-case (or close to worst-case) behaviors, a huge (often prohibitive) number of test cases needs to be considered.
- Testing to detect worst-case memory and/or timing behavior can be complex and time-consuming. The results are often only available late in the development cycle and cannot be used to optimize the model during the development.

Recent advances in the area of static program analysis based on abstract interpretation led to the development of tools to automatically detect worst-case execution times (WCET) and worst-case stack usage like AbsInt's timing analyzer aiT and StackAnalyzer (see [10] for a survey of timing analysis tools). Such tools that determine safe and precise bounds on resource usage can be very helpful for SCADE users.

In the context of safety-critical hard real-time applications, aiT and StackAnalyzer are used as verification tools, i.e., they are used to demonstrate and prove that pieces of code are guaranteed to always execute within limited time intervals and resource bounds.

In this paper, we propose to complement model-based design processes with static program analysis tools. We argue that to develop hard real-time systems, model-driven development coupled with detailed analysis of the implemented software is much better suited than traditional development methods that rely on programming C code.

The users of SCADE usually work on a much more abstract level than the producers of manual code.

Our tight integration enables the SCADE user to conveniently access static analysis results from within the SCADE development environment. This gives SCADE users a direct feedback on the effects of their design decisions on the resource usage, allowing them to select more efficient designs and implementation methods.

In the following, we present the tools, the experimental integration, preliminary results and plans for further tool integration.

## 2. SCADE Language and Toolset

SCADE is a model-based design tool dedicated to the development of safety-critical embedded systems that require certification, for example subject to DO-178B, IEC 61508, EN 50128, or ISO 26262 standards. SCADE modeling capabilities cover the design, verification, and optimization of complex algorithms, control intensive applications, and graphic interfaces. Furthermore, the SCADE automatic code generator has been qualified to produce a portion of the evidence mandated by certification authorities, supporting a safety-critical process in a cost-effective manner.

The SCADE language provides a graphical and textual notation to express data-flow and control-flow. The data-flow is defined in a declarative way through equations and the control flow is expressed with control structures that go from simple “if-then-else” like constructs to complex hierarchical and parallel state machines called Safe State Machines (SSM). In SCADE 6 both data-flow and SSM formalisms can be mixed and nested one into the other without limitation (see section 5), with both formalisms sharing the same fundamental interpretation and characteristics, namely:

- Explicit data typing,
- Explicit management of discrete time,
- Single assignment in data-flow,
- Concurrency solved through synchronous behavior and data and control dependencies,
- Deterministic execution.

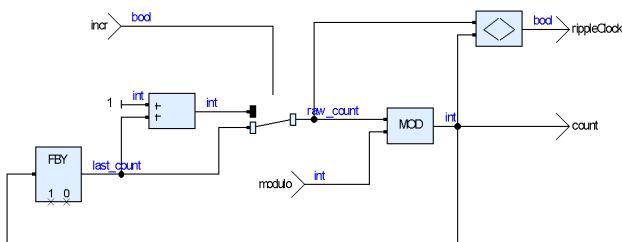

Figure 1: SCADE operator `modCount`

Figure 1 pictures a simple SCADE dataflow operator. The predefined SCADE operator `FBY` is a de-

lay of  $n$  ticks,  $n$  being its first parameter; at initialization the output value is given by the second parameter, here 0. The operator defined in Figure 1 is a simple counter modulo the value `modulo` provided as input. The counter value is incremented at each tick in which input `incr` is true. Output `rippleClock` is true when the counter is reset by the modulo operator.

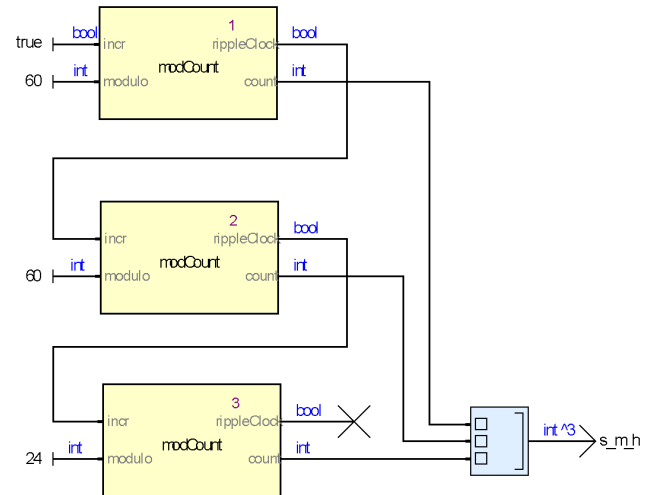

Figure 2: SCADE operator `countTime1`

An operator can be instantiated several times as in Figure 2. The instance number appears at the top right corner of the instance. Instance 1 of `modCount` increments the output at each tick (input `incr` is always true). Each time it is reset, it causes an increment in the second instance of `modCount` because the output `rippleClock` of the first instance is connected to the input `incr` of the second. Same for the 3<sup>rd</sup> instance that counts only when the 2<sup>nd</sup> instance reaches 60. The output of the operator `countTime1` is a vector of 3 integers that represents the time in [seconds, minutes, hours] if it is called at every second.

SCADE 6 introduces loops via iterator constructs as a means to perform computations on arrays. Iterators come in two families:

- Map iterators, which apply a SCADE 6 operator to a bunch of arrays of identical size as input, and produce a bunch of arrays of the same size as output. The SCADE 6 operator is applied to each array component independently. A map iterator can be used to compute the sum of two vectors for instance ( $c[i] = a[i] + b[i]$ ).
- Fold iterators, which apply a SCADE 6 operator to an array and an accumulator, iterating from the first array cell to the last one. Each computation is applied to the value of the current cell and the previous accumulator value, leading to a new accumulator value. The final result is the

last accumulator value. A fold iterator can be used to sum up all the cell values of a given array ( $b = a[0] + a[1] + \dots + a[n - 1]$ ).

Both families of iterators have variants that use a stop condition. As soon as the condition is false, the iteration stops. In all cases, the generated code is guaranteed to generate bounded loops that have statically determined iteration bounds.

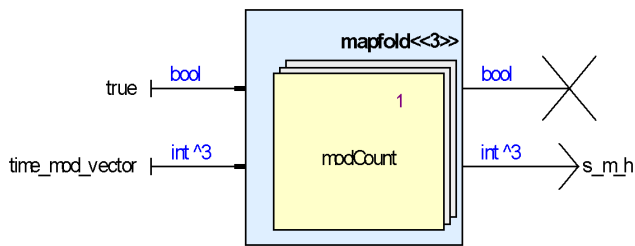

Figure 3: SCADe operator `countTime2`

An additional iterator, `mapfold`, is a combination of `map` and `fold`. It can be used to implement the functionality of `countTime1` in a more concise way (see Figure 3). The `mapfold` iterator, as all iterators, applies to an operator (here `modCount`), and is used with an iteration number of 3 in this case, as we want to instantiate `modCount` 3 times. The first input of an operator under a `mapfold` is the accumulator input, while the first output is the accumulator output. With SCADe constant `time_mod_vector` defined as [60,60,24], the behavior of operator `countTime2` is the same as the one from `countTime1`.

From a SCADe design, the SCADe code generator generates a set of C functions, forming a call graph from a root function that executes one step of computation. Another set of functions is also generated for the initialization of the memory that is the context on which the step function is applied. To develop a complete embedded application, these functions (reset and cycle) must be called from a main function that also integrates calls to drivers, and interacts with the underlying Operating System. This code generated by SCADe is in general extended by hand-written user integration code. Then all that code must be compiled and linked to get an executable that can then be downloaded on the target.

The code generated by KCG from operator `countTime2` is given below.<sup>1</sup> The reset and cycle functions call respectively the reset and cycle functions generated from operator `modCount` within a loop that implements the `mapfold` iterator.

<sup>1</sup>The formatting has been changed to let the code fit better to the given column width.

```
void countTime2_reset(outC_countTime2 *outC) {
    kcg_int i;
    for (i = 0; i < 3; i++) {
        modCount_reset(&outC->Context_modCount[i]);
    }
}
```

```
void countTime2(outC_countTime2 *outC) {
    kcg_bool tmp;
    kcg_int i;
    /* P1::countTime2::_L3 */
    kcg_bool _L3;
    _L3 = kcg_true;
    for (i = 0; i < 3; i++) {
        modCount(_L3, time_mod_vector[i],
                &outC->Context_modCount[i]);
        outC->s_m_h[i] =
            outC->Context_modCount[i].count;
        tmp=outC->Context_modCount[i].rippleClock;
        _L3=tmp;
    }
}
```

SCADe KCG has several optimization options. One of the most interesting is the ability to inline the equations from any operators as first step of the compilation. This allows inter-operator optimizations. Generated code from `countTime2` with `modCount` inlined is shown below.

```
void countTime2_reset(outC_countTime2 *outC) {
    kcg_int i;
    for (i = 0; i < 3; i++) {
        outC->init_1[i] = kcg_true;
    }
}
```

```
void countTime2(outC_countTime2 *outC) {
    kcg_bool tmp;
    kcg_int i;
    /* modCount_3_raw_count */
    kcg_int raw_count_1;
    /* modCount_3_last_count */
    kcg_int last_count_1;
    /* P1::countTime2::_L3 */
    kcg_bool _L3;
    _L3 = kcg_true;
    for (i = 0; i < 3; i++) {
        if (outC->init_1[i]) { last_count_1 = 0; }
        else { last_count_1 = outC->count_1[i]; }
        if (_L3) { raw_count_1 = 1+last_count_1; }
        else { raw_count_1 = last_count_1; }
        outC->count_1[i] =
            raw_count_1 % time_mod_vector[i];
        tmp = raw_count_1 != outC->count_1[i];
        outC->s_m_h[i] = outC->count_1[i];
        outC->init_1[i] = kcg_false;
        _L3 = tmp;
    }
}
```

In order to generate code that can be qualified against stringent rules such as the one from

DO178B, KCG must ensure a high traceability between the model and the generated code. This feature directly benefits the SCADE-aiT coupling.

### 3. StackAnalyzer and aiT

aiT is AbsInt's timing analyzer, which can find upper bounds for the worst-case execution times (WCETs) of sequential tasks. StackAnalyzer can find upper bounds for the stack usage in an application. For a precise computation of WCET and stack usage, aiT and StackAnalyzer operate on the executable. Both tools exist in different versions, depending on the target architecture.

The latest versions of aiT and StackAnalyzer share a GUI that offers ways to specify the memory architecture of the target, the location of source files, the name of the executable, the name of a separate parameter file called AIS file, the name of the report files to be written, etc., and the start point of the analysis (a routine name or an address). All this information can be stored in a project file. The AIS file may contain the clock rate of the target processor, upper bounds for the iteration numbers of loops, possible targets of computed calls, etc. The analyses of aiT/StackAnalyzer are mainly based on the executable. If available, aiT/StackAnalyzer can also read the source files for further information. The association between addresses in the executable and positions in the source files is obtained from the debug information in the executable.

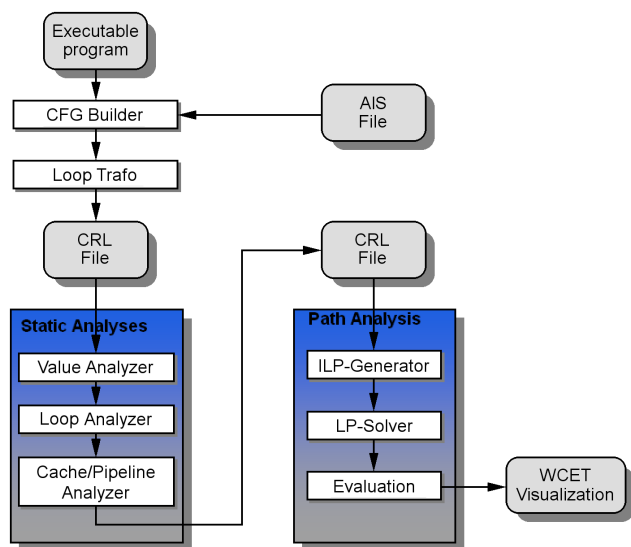

Figure 4: Phases of WCET computation

aiT determines the WCET of a given task in several phases [4] (see Figure 4). In the first step a decoder reads the executable and reconstructs the control flow [8]. Then, value analysis determines lower and upper bounds for the values in the processor registers for every program point and execution context,

which lead to bounds for the addresses of memory accesses (important for cache analysis and if memory areas with different access times exist). Value analysis can also determine that certain conditions always evaluate to true or always evaluate to false. As consequence, certain paths controlled by such conditions are never executed. Thus value analysis can detect and mark some unreachable code.

WCET analysis requires that upper bounds for the iteration numbers of all loops be known. aiT tries to determine the number of loop iterations by loop bound analysis [5], but succeeds in doing so for simple loops only. Bounds for the remaining loops must be provided as specifications in the AIS file or annotations in the C source.

If the target processor has caches, an optional cache analysis follows, which classifies the accesses to main memory into hits, misses, or accesses of unknown nature. Pipeline analysis models the pipeline behavior to determine execution times for sequential flows (basic blocks) of instructions as done in [7]. It takes into account the current pipeline state(s), in particular resource occupancies, contents of prefetch queues, grouping of instructions, and classification of memory references by cache analysis. The result is an execution time for each basic block in each distinguished execution context.

Using this information, path analysis determines a safe estimate of the WCET. The program's control flow is modeled by an integer linear program [6, 9] so that the solution to the objective function is the predicted worst-case execution time for the input program.

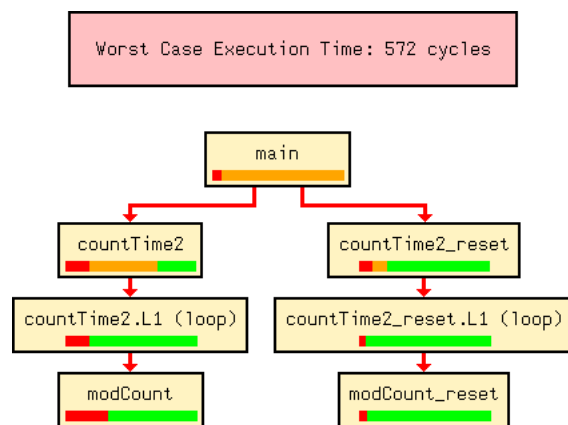

Figure 5: Phases of WCET computation

After a successful analysis, aiT reports its results in several ways:

1. aiT can produce a graphical output showing the call graph of the analyzed part of the application, consisting of the routines and their calling relationships (see Figure 5). The routine



boxes can be opened to show their control-flow graphs with WCET results or stack levels for basic blocks. Technically, aiT writes a description of these graphs in a GDL file, which can be visualized by AbsInt’s graph browser aiSee.

- aiT can write a text report meant to be human readable, and a more formal XML report. These reports contain detailed results for all analyzed routines in all calling contexts, including specific results for the first few iterations of loops vs. a result for the remaining iterations. The XML report file is used in the SCADE-aiT integration.

#### 4. SCADE-aiT-Integration

##### 4.1 Use scenarios

aiT and StackAnalyzer operate on the executable for a precise computation of WCET and stack usage. The coupling between SCADE and aiT/StackAnalyzer should support the use of the WCET/stack computation in the following two scenarios:

- at the design phase of the SCADE model, and,
- together with the user-defined integration code.

For the first scenario, a simple integration code will be automatically generated by the SCADE/aiT integration in order to perform WCET/stack analysis directly from the SCADE IDE without the need for manually writing C code. For the second scenario, aiT and StackAnalyzer are used directly on the final application.

Since feedback of the computed WCET information to the SCADE model should be provided when only parts of the application come from a SCADE design, we propose to use the SCADE/aiT integration also in this case, but without automatically generated integration code, using the final executable instead.

##### 4.2 Analyzability of the SCADE-generated code

Thanks to the good properties of the SCADE language, the code generated by SCADE KCG is very regular by nature and poses no special challenges for the analysis.

Stack analysis does not cause any difficulties, as there is no recursion in SCADE generated code, so the stack size is always bounded and statically computable.

The WCET analysis by aiT requires that upper bounds for the iteration numbers of all loops are known. This is the case for all loops generated by SCADE KCG. The bounds are communicated to the aiT tool via AIS specifications (referring to a source code line), e.g.,

```
loop file 'name' line number
    max bound by default;
```

##### 4.3 Workflow

The global workflow for the coupling is pictured in Figure 6.

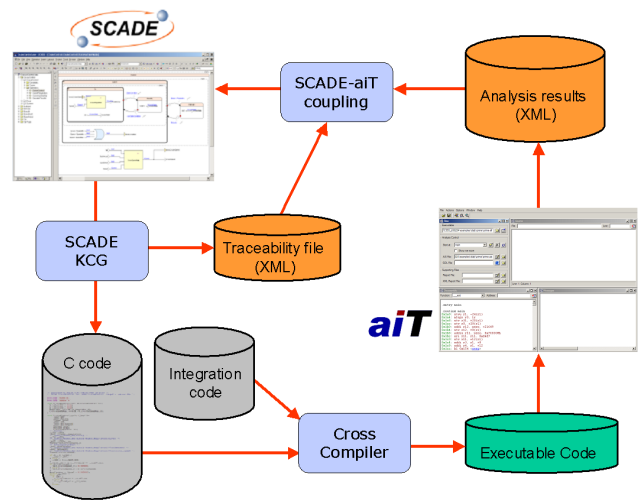

Figure 6: SCADE-aiT workflow

- The SCADE Code Generator generates C code from a SCADE model.
- This code is compiled and linked with user integration code to get an executable.
- aiT performs the WCET analysis on the executable and produces results for the routines in the executable, which correspond to C functions.

The traceability information that is also produced from the SCADE Code Generator provides the detailed relation from SCADE operators to generated C functions. This information is used for feeding back WCET results to the SCADE model.

The following issues are detailed in the next sections:

- Integration code generation
- Linking the information between the tools
- Reporting the information in the SCADE IDE

##### 4.4 Integration code generation

As expressed in section 4.1, there are two different possibilities for the integration code:

1. A simple integration code that is automatically generated;
2. User code defined outside the SCADE environment.

Case 2 requires no special handling. aiT is used on the final executable.

In Case 1, additional C-files are generated from SCADE tools. This is implemented by the “wrapper” mechanism of SCADE tools, which is a means

to extend the code generation action with other actions, in particular the generation of additional files like “capsule code” that defines a C `main()` function that calls the SCADE generated code.

As shown in section 2, SCADE KCG generates two functions per operator `Op`:

- `Op_reset()` that must be called once, before any cycle `Op()` is executed;
- `Op()` that performs one execution of the operator.

Usual application code looks like this:

```
main() {
    // declarations
    Op_reset();
    while (true) {
        //get sensor values
        Op();
        //update actuators
    }
}
```

This is a non-ending loop that clearly has no finite WCET and can thus not be analyzed by aiT. Therefore, we generate an alternative code pattern for analysis with aiT. The minimal main code would look like:

```
main() {
    // declarations
    Op_reset();
    Op();
}
```

But `Op_reset()` sets Boolean variables that are later on tested in `Op()` to distinguish between the first execution of the operator and any subsequent executions, then reset to false in `Op()`.

With the main code proposed above only the “true” part of the conditionals is used in the first execution of `Op()`, while later executions of `Op()` in the real application may also use the “false” part. Thus, this simple code can lead to wrong WCET results because aiT recognizes and uses data dependencies between the functions called. Calling `Op()` a second time in the “main” wrapper does not solve the problem because in deeper levels of the code, the first execution of an operator with memory can be delayed to several steps from the beginning.

To keep the independence between the `Op_reset()` and `Op()` functions and the volatile aspect of input and output contexts and to determine an overall WCET valid for all executions, it is possible to create an `analyze` function that takes two pointers to contexts, one for the `Op_reset()` function and the other for the `Op()` function.

```
analyze(CtxInType * initInCtx,
        CtxInType * cycleInCtx,
        CtxOutType * initOutCtx,
        CtxOutType * cycleOutCtx) {
    // declarations
    Op_reset (initInCtx,  initOutCtx);
    Op      (cycleInCtx,  cycleOutCtx);
}
```

Using these contexts it is possible to distinguish between invariant data set in `Op_reset()` and used in all instances of `Op()`, and volatile data set in `Op_reset()`, but modified in `Op()` and thus used only in the first instance or first few instances of `Op()`.

A main function calling the `analyze()` function is also generated. Finally a complete makefile based on a makefile template provided by the user to set all cross compiler and linker paths and options is generated.

#### 4.5 Linking the information between the tools

The results computed by aiT should be mapped back into the SCADE model so that SCADE users can see the results as additional information at the appropriate SCADE operators at the level of the model, without the need to look at the generated C code.

In order to show the SCADE-aiT coupling on a model with more than two operators, the example used hereafter is a car Cruise Control demo example designed with SCADE.

As detailed in previous sections, each SCADE operator is implemented as two C functions, one for the initialization of the operator and one for its normal cyclic execution. Depending on the compiler used or the options given to the compiler, the C function names may not be the same as the SCADE operator names; some compilers for instance put an underscore “\_” before the name and/or shorten the identifier. This did not happen in the example presented in Figure 7; if it happens, an association between C names and assembly names must be maintained. This is done via a mapping file generated from KCG. In the example of Figure 7, operator `CruiseSpeedMgt` e.g., is mapped to C functions `CruiseSpeedMgt_CruiseControl` and `CruiseSpeedMgt_reset_CruiseControl`.

The XML report file produced by aiT contains WCET estimations for assembly routines. The mapping from assembly routine names to times is realized in an indirect way: the XML output file assigns internal identifiers to the routine names; in Figure 7 these are `tqc` for `CruiseSpeedMgt_reset_CruiseControl` and `amc` for `CruiseSpeedMgt_CruiseControl`. aiT’s

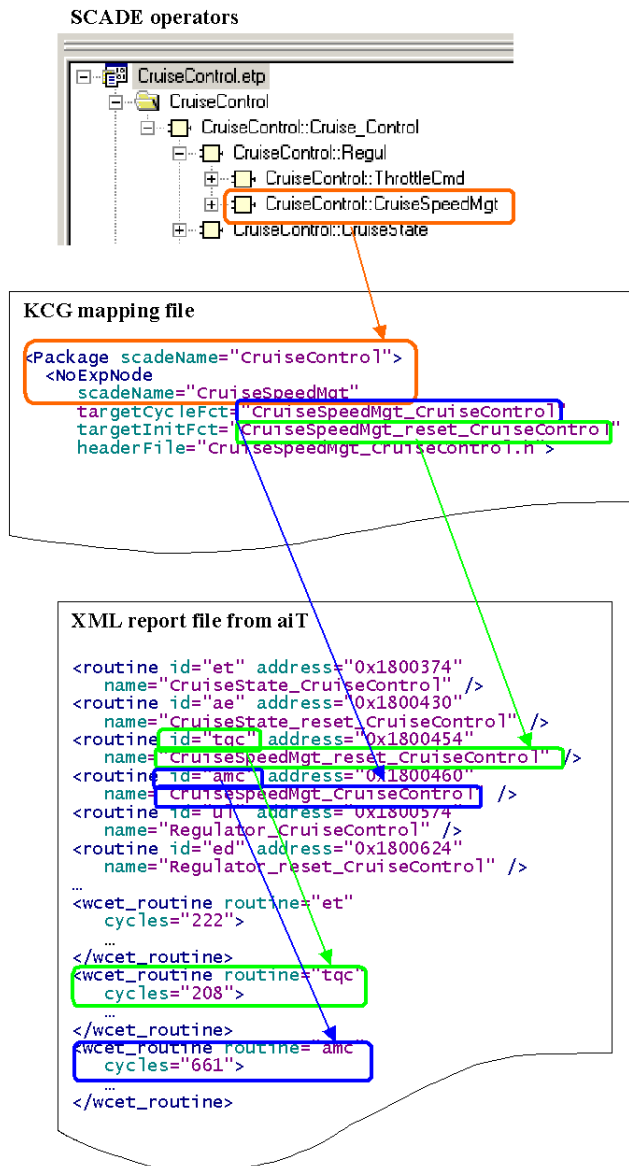

Figure 7: Linking assembly code to SCADE operators through C code

WCET estimates for these routines can then be found via these routine identifiers (208 cycles for `tqc` and 661 cycles for `amc`).

As shown in Figure 7, all the needed information is there to allow a direct feedback from the analysis made on the executable by aiT to the user design in the SCADE IDE.

#### 4.6 Sessions and difference reports

Whatever is the chosen production method for the binary (with auto-generated main and makefile, or using “classical” means), it is interesting to be able to report the effect of changes in the SCADE design and/or in the KCG options. For this, users should be able to handle data obtained from several differ-

ent launches of aiT from the SCADE IDE.

For this reason, we have introduced the concept of sessions. A session is a set of data obtained from one aiT launch. It contains:

- SCADE KCG options,
- aiT options,
- WCET data attached to nominal items from the SCADE call graph.

Sessions allow the comparison of WCET results resulting from different runs with different SCADE modeling, KCG options, cross-compiler options, and aiT options. Sessions can be selected individually from a panel created in the SCADE IDE.

From the created sessions, the following actions are possible:

- open a session report window (described below), by double-clicking on a session;
- open a diff report by selecting two session items.

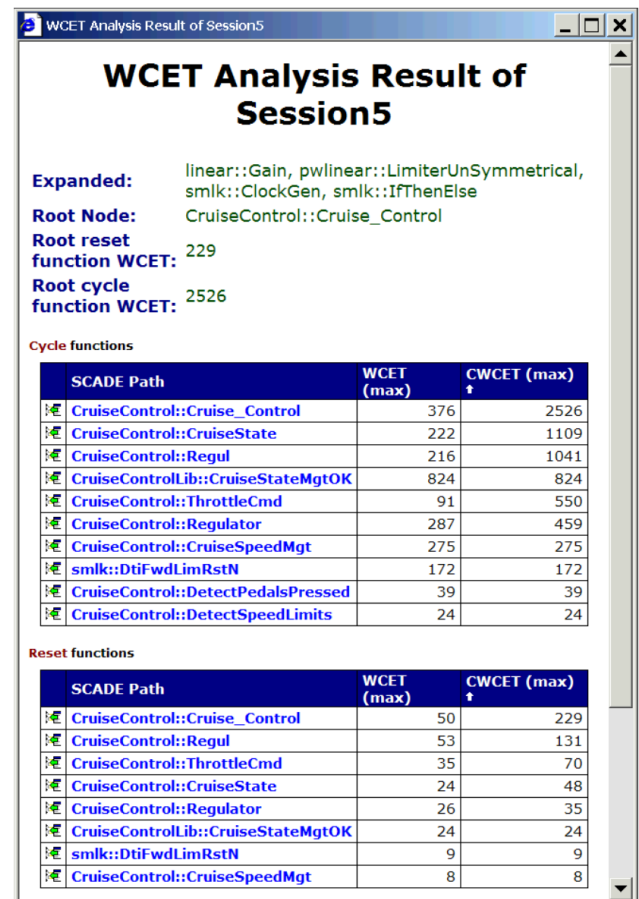

Figure 8: WCET analysis report

The session report window (Figure 8) gives an overview of aiT results corresponding to SCADE operators to be able to quickly locate bottleneck operators. The SCADE operators are listed in two tables, the first one for cycle functions and the other one



for reset functions. Each may show the following values:

**WCET:** WCET contribution of the function without descendants. The max, the average, and the sum of the function WCETs computed for individual calling contexts are given.

**CWCET:** WCET contribution of the function with descendants. The max, the average, and the sum of the function WCETs computed for individual calling contexts are given.

**Max Space:** The maximum stack usage of the function without parent stack usage.

**CMax Space:** The maximum stack usage of the function cumulated with parent stack usage.

The representation allows sorting each column. The report can be customized through an option mechanism offering the possibility to hide some columns (this has been done for the report shown in Figure 8).

Each operator definition can be located in the SCADE model by clicking on the “Show in model” icon. A detailed report of a specific SCADE operator can be opened by clicking on the corresponding link in the session report. This detailed report displays the information given by the session report and shows the WCET contribution of each child.

Cycle functions

SCADE Path	WCET (max)		
	Session5 ↑	Session6	Diff
CruiseControlLib::CruiseStateMgtOK	824	298	-526
CruiseControl::Cruise_Control	376	379	+3
CruiseControl::Regulator	287	237	-50
CruiseControl::CruiseSpeedMgt	275	221	-54
CruiseControl::CruiseState	222	142	-80
CruiseControl::Regul	216	217	+1
smlk::DtIFwdLimRstN	172	120	-52
CruiseControl::ThrottleCmd	91	93	+2
CruiseControl::DetectPedalsPressed	39	-	-
CruiseControl::DetectSpeedLimits	24	-	-

Figure 9: Session diff report

The diff report (Figure 9) is structured in the same way as the session report, but for each data, the report displays the values for both sessions, and the (absolute and relative) difference between them. The diff report can be customized in the same way as the session report.

The diff report shows precisely, at model level, the effect of the options set for SCADE KCG or the cross compiler. The example from Figure 9 shows the effect of selecting a higher optimization level in KCG, and inlining two more operators. Improvement is clear for all operators but three whose WCET slightly increased.

## 5. Evaluation on an industrial model

The technologies presented in this paper have been evaluated on real-size applications. We give here metrics on a Fuel Management Controller for a civil aircraft (more precise information cannot be disclosed). As a safety-critical application, the code must be certified against DO178B level A; it is a typical application for SCADE design, code being generated by SCADE KCG.

The SCADE model comprises about 80 operators, and the depth of instances reaches 9. The top-level operator has more than 20 inputs, several being arrays of 30 elements, and 9 outputs that are also arrays and one structure of arrays. The model contains about 50 iterators, i.e., 50 loops in the generated C code, some being nested loops.

SCADE KCG has been used with different options, in order to examine their influence on the WCET of the application via the diff feature of the SCADE-aiT coupling. If the highest KCG optimization level (level 3) is selected, and all operators are inlined except for the main 20 top-level operators, 6500 lines of C code are generated. The executable was built with the Wind River Compiler, with standard optimization level, for target PowerPC 555.

aiT performed the WCET analysis in 15 seconds, the result being a WCET of 270,000 cycles. With a 40 MHz processor, this gives a WCET of 6.75 ms.

## 6. Planned Extensions

As described in section 2, SCADE 6 unifies dataflow and hierarchical state machines paradigms. For details on the semantics of such a unification, see [1, 2]. Figure 10 gives an example. This model is detailed in the SCADE Language tutorial [3]. It is the chronometer part of a standard digital watch model; the **Chrono** automaton that uses the **modCount** operator runs in parallel with the **Display** automaton.

The code generated from SCADE KCG for such a model consists in nested C switches, basically with one case per automata state. C functions are generated only for non-inlined operators. For a model with a hierarchy of several levels of macro-states and dozens or even hundreds of states, aiT computes the WCET for the whole operator. In practice the worse case corresponds to one state for each of the parallel automata. If the WCET value must be improved, one needs to know which automaton’s states must be redesigned or split. Generating an aiT parameterization file from the SCADE model, and completing the XML files for the linking operation should allow us to reach this goal.

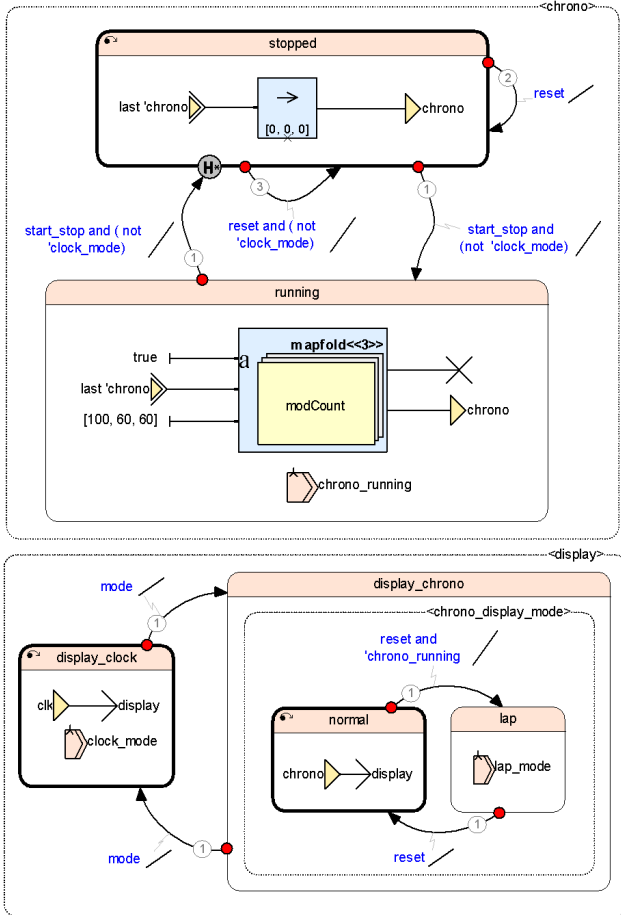

Figure 10: SCADE Unified Modeling Style

## 7. Conclusion

Tools based on abstract interpretation can perform static program analysis of embedded applications. Their results hold for all program runs with arbitrary inputs. Employing static analyzers is thus orthogonal to classical testing.

Combined with model-based design and automatic code generation, the potential of static analysis tools is increased greatly: More strict specification and development guidelines enforced by tools like SCADE allow for a high precision of the analyzer's estimates. The resulting combination allows for the development of more secure and better-performing systems while decreasing time-to-market through enhancing development productivity.

For the developer, the immediate and detailed feedback provided by mapping back aiT's results into the SCADE IDE helps to find the critical areas of the project where most of the resources are spent. The concept of diff reports also helps to decide between alternatives to solve a given problem. Using model-based design, different modeling techniques can lead to strongly varying code. Here, the infor-

mation provided by aiT can help to prototype and develop software more rapidly.

## 8. Acknowledgement

The authors acknowledge Jean-Louis Colaço, one of the main designers of the SCADE 6 language, who made the first experiments with WCET analysis on code generated from SCADE KCG.

Collaboration between AbsInt GmbH and Esterel Technologies has been supported by the FP6 STREP project INTEREST (INTEgrating euRo-pean Embedded Systems Tools).

## 9. References

- [1] Jean-Louis Colaço, Bruno Pagano, and Marc Pouzet. A conservative extension of synchronous data-flow with state machines. In Wayne Wolf, editor, *Proceedings of EMSOFT 2005, 5th ACM International Conference On Embedded Software*, pages 173–182. ACM, 2005.
- [2] François-Xavier Dormoy. SCADE 6 – A model based solution for safety critical software development. In *4th European Congress ERTS Embedded Real Time Software, Toulouse, France, January 2008*.
- [3] Esterel Technologies. SCADE language tutorial. <http://www.esterel-technologies.com>, September 2007.
- [4] Christian Ferdinand, Reinhold Heckmann, Marc Langenbach, Florian Martin, Michael Schmidt, Henrik Theiling, Stephan Thesing, and Reinhard Wilhelm. Reliable and precise WCET determination for a real-life processor. In *Proceedings of EMSOFT 2001, First Workshop on Embedded Software*, volume 2211 of *Lecture Notes in Computer Science*, pages 469–485. Springer-Verlag, 2001.
- [5] Christian Ferdinand, Florian Martin, Christoph Cullmann, Marc Schlickling, Ingmar Stein, Stephan Thesing, and Reinhold Heckmann. New developments in WCET analysis. In Thomas Reps, Mooly Sagiv, and Jörg Bauer, editors, *Program Analysis and Compilation, Theory and Practice*, volume 4444 of *Lecture Notes in Computer Science*, pages 12–52. Springer-Verlag, 2007.
- [6] Yau-Tsun Steven Li and Sharad Malik. Performance Analysis of Embedded Software Using Implicit Path Enumeration. In *Proceedings of the 32nd ACM/IEEE Design Automation Conference*, 1995.
- [7] Jörn Schneider and Christian Ferdinand. Pipeline Behavior Prediction for Superscalar Processors by Abstract Interpretation. In *Proceedings of the ACM SIGPLAN Workshop on Languages, Compilers and Tools for Embedded Systems*, volume 34, pages 35–44, May 1999.
- [8] Henrik Theiling. Extracting Safe and Precise Control Flow from Binaries. In *Proceedings of the 7th Conference on Real-Time Computing Systems and Applications*, Cheju Island, South Korea, 2000.

- [9] Henrik Theiling and Christian Ferdinand. Combining abstract interpretation and ILP for microarchitecture modelling and program path analysis. In *Proceedings of the 19th IEEE Real-Time Systems Symposium*, pages 144–153, Madrid, Spain, December 1998.
- [10] Reinhard Wilhelm, Jakob Engblom, Andreas Ermedahl, Niklas Holsti, Stephan Thesing, David Whalley, Guillem Bernat, Christian Ferdinand, Reinhold Heckmann, Tulika Mitra, Frank Mueller, Isabelle Puaut, Peter Puschner, Jan Staschulat, and Per Stenström. The worst-case execution time problem – overview of methods and survey of tools. *ACM Transactions on Embedded Computing Systems*, 5:1–47, 2007.