



HAL
open science

Diurnal variation of nitric oxide in the upper stratosphere

Y. Kondo, P Aïmedmu, Michel Pirre, W. A Matthews, R. Ramarosan, W. Sheldon, J.L. Benbrook, A. Iwata

► **To cite this version:**

Y. Kondo, P Aïmedmu, Michel Pirre, W. A Matthews, R. Ramarosan, et al.. Diurnal variation of nitric oxide in the upper stratosphere. *Journal of Geophysical Research*, 1990, 95 (D13), pp.22513. 10.1029/JD095iD13p22513 . insu-02796542

HAL Id: insu-02796542

<https://insu.hal.science/insu-02796542>

Submitted on 5 Jun 2020

HAL is a multi-disciplinary open access archive for the deposit and dissemination of scientific research documents, whether they are published or not. The documents may come from teaching and research institutions in France or abroad, or from public or private research centers.

L'archive ouverte pluridisciplinaire **HAL**, est destinée au dépôt et à la diffusion de documents scientifiques de niveau recherche, publiés ou non, émanant des établissements d'enseignement et de recherche français ou étrangers, des laboratoires publics ou privés.

Diurnal Variation of Nitric Oxide in the Upper Stratosphere

Y. KONDO,¹ P. AIMEDIEU,² M. PIRRE,³ W. A. MATTHEWS,⁴ R. RAMAROSON,³
W. R. SHELDON,⁵ J. R. BENBROOK,⁵ AND A. IWATA¹

Two recent measurements of the temporal variation of nitric oxide at constant altitude near 40 km are reported. The observations were made at float altitude with a balloon-borne chemiluminescence detector together with *in situ* ozone measurements. The first measurement was made at 44°N on September 17, 1987, at an altitude of 40 km from before sunrise until 1000 LT. The second observation was made at the same latitude on June 18, 1988 at 39 km from 0800 to 1230 LT. The precision of the NO measurements is about 10% at these altitudes, obtained through a more accurate determination of the sample flow rate at pressures down to 2 mbar with a reduced ozone/oxygen flow rate. At an altitude of 40 km, nitric oxide was observed to start increasing very rapidly at sunrise when the solar zenith angle reached about 95°. After the rapid initial buildup, the rate of NO increase stabilized for 3 hours at about 1.2 ppbv/hour. Near 1100 LT at 39 km in summer the NO mixing ratio was observed to become nearly constant. These features of the diurnal variation of NO are in accord with the temporal variation expected from a time-dependent zero-dimensional photochemical model. Mixing ratios of NO_y and N₂O₅ have been determined from the measured temporal variation of NO at 39.5 ± 0.5 km, using the photochemical model of Pirre *et al.* (1989). These derived values of the NO_y and N₂O₅ mixing ratios, 15.5 ± 5.0 ppbv and 1.4 ± 0.6 ppbv, respectively, are in good agreement with other recent measurements by balloon-borne and space-borne infrared experiments.

INTRODUCTION

The catalytic reaction cycle of atomic oxygen and ozone with nitric oxide (NO) and nitrogen dioxide (NO₂) is estimated to be the major loss process for ozone throughout the stratosphere below about 40 km [e.g., McElroy and Salawitch, 1989]. In addition, these oxides of nitrogen (NO_x) interact with reactive chlorine species in the following way: NO reacts with ClO through the reaction



which competes with the reaction



Reaction (R2), together with reaction

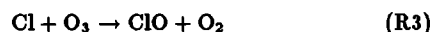

completes the well-known catalytic cycle of ozone destruction. The role of reaction (R1) is pronounced in the upper stratosphere, where NO is relatively abundant. In the lower stratosphere, reaction



becomes important in temporarily sequestering both ClO_x and NO_x. Since there is interaction between reactive species of chlorine and nitrogen, it is predicted that the rate of ozone destruction by an increase in stratospheric chlorine depends critically on the NO_x or NO_y concentration [e.g., Isaksen and Stordal, 1986].

In the daytime upper stratosphere, nitric oxide (NO) becomes the most abundant species of total reactive nitrogen, defined as NO_y = NO + NO₂ + NO₃ + 2(N₂O₅) + HNO₃ + HNO₄ + ClONO₂. The concentration of NO is controlled by the NO_y concentration and the photochemical partitioning among the NO_y species. The dominance of NO in the NO_y family during the daytime is discussed later when the measurements are compared to the model calculations of Pirre *et al.* [1989]. Since NO_y has a photochemical time constant of about a month in the upper stratosphere [Shimazaki, 1984], it is constant on the time scale of a day in the same air mass. Consequently, the diurnal variation of NO is caused by change in the NO/NO_y ratio which results from photodissociation of reservoir species such as N₂O₅ and ClONO₂, and by variation in the NO/NO₂ ratio. In order to investigate the complex chemistry of odd nitrogen in the stratosphere under changing conditions of solar illumination, precise measurements of the diurnal variation of NO in the same air mass are needed.

Observations of the diurnal variation of NO in the upper stratosphere are very limited; however, at lower altitudes, more observations have been made, mainly with *in situ* chemiluminescence NO detectors [e.g., Ridley *et al.*, 1977; Kondo *et al.*, 1985, 1988, 1989a, b] (see Kondo *et al.*, [1988] for a more complete set of references). Ridley and Schiff [1981] measured the temporal variation of NO at 40 km near sunset. Roscoe *et al.* [1986] observed the temporal variation of NO between 32 and 43 km in the morning hours, as well as in the afternoon, using a balloon-borne infrared emission radiometer. To investigate the photochemistry of odd nitrogen, precise measurements of NO in the morning are very important because photodissociation of the various reservoir species, such as N₂O₅, occurs at that time.

The NO measurements reported here are more accurate than previous determinations using the chemiluminescent technique.

¹Solar-Terrestrial Environment Laboratory, Nagoya University, Japan.

²Service d'Aéronomie, Centre National de la Recherche Scientifique, France.

³Laboratoire de Physique et Chimie de l'Environnement, Centre National de la Recherche Scientifique, Orléans, France.

⁴Department of Scientific and Industrial Research, Physical Sciences, New Zealand.

⁵Department of Physics, University of Houston, TX.

Copyright 1990 by the American Geophysical Union.

Paper number 90JD01981.
0148-0227/90/90JD-01981\$05.00

We have significantly improved the precision of chemiluminescent NO measurements, mainly through a more precise determination of the flow rates relevant to our balloon-borne chemiluminescence detector [Kondo *et al.*, 1989c]. Here the diurnal variation of NO at about 40 km from sunrise through midafternoon is reported. Quantitative comparison of the observed results with a photochemical model is described. A detailed analysis of the observed and calculated diurnal NO variation allowed estimates to be made of the NO_y and N₂O₅ mixing ratios.

INSTRUMENTATION

The two balloon measurements of NO presented here were made in 1987 and 1988 with a chemiluminescence detector. This instrument was used previously for balloon observations up to 32 km in 1983 and 1985 [Kondo *et al.*, 1985, 1988]; after those experiments the instrument was modified to achieve better precision at 40 km. Detailed descriptions of the chemiluminescence NO detector used for the present experiments have been presented by Kondo *et al.* [1989a, b, c]. Fluctuations of the zero level of the instrument have been used to obtain an estimate of 25 pptv as the detection limit of the NO instrument for 10 s of operation. This value was confirmed during the nighttime flight in 1987, as described later. For NO mixing ratios above the detection limit the major sources of error in the NO measurements are the uncertainty in the mixing ratio of NO in the N₂ gas used for calibration during flight, and the mass flow rates of the NO calibration gas and of the sample air. The fluctuation level of the signal is not significant during daytime NO measurements. One of our gas bottles with an NO concentration of 1.98 ppmv used for calibration has been evaluated recently at the NOAA Aeronomy Laboratory where this value was confirmed within an accuracy of 3% (D. W. Fahey, private communication, 1990). Estimates of the uncertainties in the NO measurements are given in Table 1. The precision of the NO measurement derived by adding these uncertainties is about 10%. For the second balloon experiment in 1988 the NO instrument was further modified to measure NO_y by adding a gold converter [Kondo *et al.*, 1990]. A schematic diagram of the NO/NO_y instrument is shown in Figure 1. The sample air is drawn through the inlet by a Roots pump directly to the reaction chamber for NO measurements. In an alternative measurement mode, sample air first passes through a gold converter heated to 300°C to reduce NO_y into NO catalytically, upstream of the reaction chamber. In order to maintain a high conversion efficiency of NO_y to NO, purified carbon monoxide (CO), passed through charcoal and Teflon filters, is mixed with

the sample air [Bollinger *et al.*, 1983; Fahey *et al.*, 1985]. The efficiency of conversion of NO₂ into NO has been measured in the laboratory to be 0.99±0.02 at pressures between 7 and 60 mbar [Kondo *et al.*, 1990]. The sensitivity of the NO_y system for NO is calibrated during the flight periodically in the same way as for the NO measurement. The zero level of the NO_y system is determined by adding compressed purified air near the entrance of the inlet tube. The NO_y measurement system of this NO/NO_y instrument is described in detail by Kondo *et al.* [1990]. The instrument used in the 1988 flight can be switched by telecommand from the NO to the NO_y measurement mode and vice versa during a flight. In 1988 it was operated in the NO_y mode during ascent between 12 and 28 km and in the NO mode afterward. The sources of errors that affect the precision of the NO_y measurements and their estimated values are listed in Table 1. The uncertainty of the flow rate of the sample air for NO_y measurements is significantly larger than that for NO measurements, due to a much reduced flow rate through the converter, especially at pressures lower than 30 mbar. By summing these uncertainties the precision of NO_y measurement is estimated to be 35% at 28 km and 25% at 20 km. In both flights, ozone was measured *in situ* on board the gondola with a UV photometer from the University of Houston [Robbins, 1985; Robbins *et al.*, 1990] to an accuracy of about ±5% and with a chemiluminescent ozone instrument from Service d'Aéronomie [Aimedieu and Barat, 1981; Aimedieu, 1983; Aimedieu *et al.*, 1987] to an accuracy of about ±10%.

BALLOON OBSERVATIONS

The first of these observations in the upper stratosphere was made on September 17, 1987, on a balloon launched from the Centre National d'Etudes Spatiales (CNES) balloon-launching center at Aire sur l'Adour in France (44°N, 0°W). The gondola was suspended 250 m below a 600,000-m³ balloon; launch was at 0210 universal time (UT), and float altitude of 40.2 km (2.7 mbar) was reached at around 0500 UT. Measurements of NO at this altitude were made until around 1000 UT, at which time a slow descent was initiated. The NO profile obtained during the descent has been presented by Kondo *et al.* [1989a], together with the temperature profile and the ozone profile measured by the UV photometer. The ozone mixing ratio measured at float altitude by the UV photometer and the chemiluminescence instrument were 5.8 and 5.7 ppmv, respectively; the temperature at float altitude was -27°C. A photograph taken from Meteosat II at 0930 UT shows that southern France was dotted with a light cloud cover of a few percent at that time.

The measured NO concentration versus UT at float altitude is shown in Figure 2, along with fluctuations in the altitude of the balloon. During this flight, local solar time and UT were nearly identical; local solar time was only 1.5 min ahead of UT at sunrise. The variation of the NO concentration near sunrise is shown in greater detail in Figure 3 as a function of solar zenith angle (SZA). The nighttime value of the NO mixing ratio was about 0 ±0.02 ppbv. At sunrise, when the SZA decreased to 96°, NO started to increase slightly and then increased rapidly between 95° and 91°. For reference, a calculated curve of the NO₂ photodissociation coefficient (J_{NO_2}), as described below, is also shown in this figure; the simultaneous increases in the measured NO mixing ratio and J_{NO_2} near sunrise can be noted. After 0600 UT, NO continued to increase at an average rate of 1.2 ppbv/hour for three hours. Kondo *et al.* [1988, 1989b] observed a similar increase in NO at 33 and 26

TABLE 1. Uncertainties in NO and NO_y Measurements

Parameter	Uncertainty %	
	NO	NO _y
Zero level	<0.1	5*
Mixing ratio of		
NO cal gas	3	3
Cal gas flow rate	2	2
Sample air flow rate	5†	20*
Conversion efficiency	...	2
Fluctuation of signal	1†	3*

† Values for 40-km altitude.

* Values for 28-km altitude.

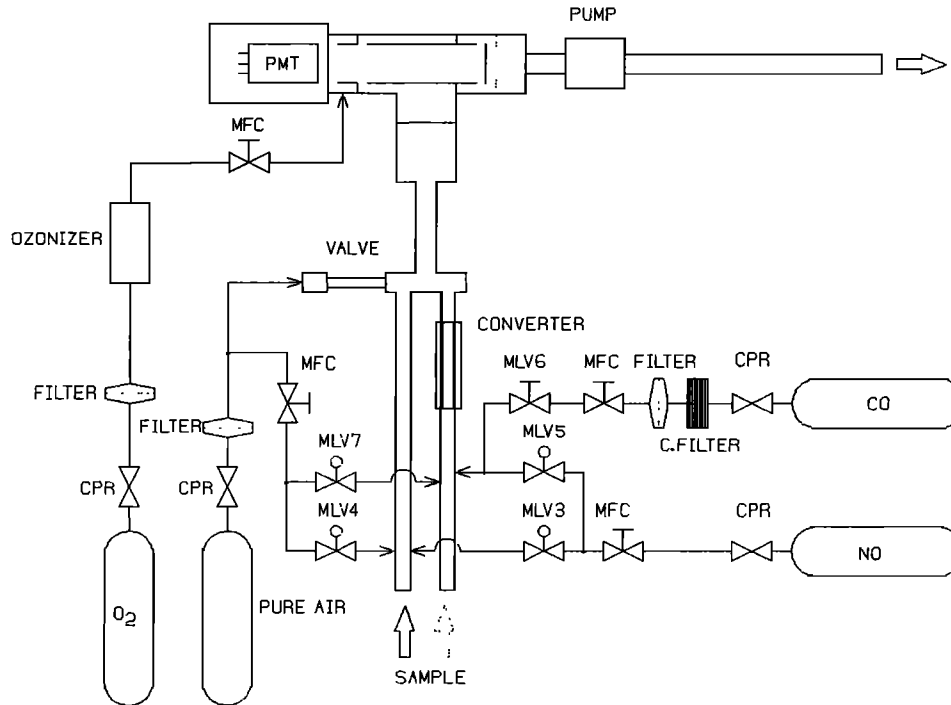

Fig. 1. Schematic diagram of the NO/NO₂ instrument used for the flight on June 18, 1988. MLV, magnetic latch valve; MFC, mass flow controller; CPR, constant pressure regu-

lator; PMT, photomultiplier tube; and C. Filter, charcoal filter.

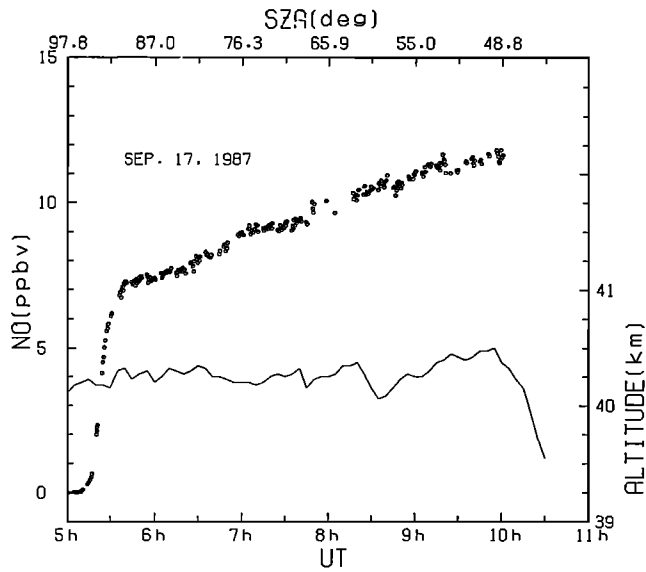

Fig. 2. Temporal variation of NO versus universal time (UT) measured at the float altitude of 40 km. The altitude of the balloon is shown as a solid line. Solar zenith angle (SZA) is given on the upper scale.

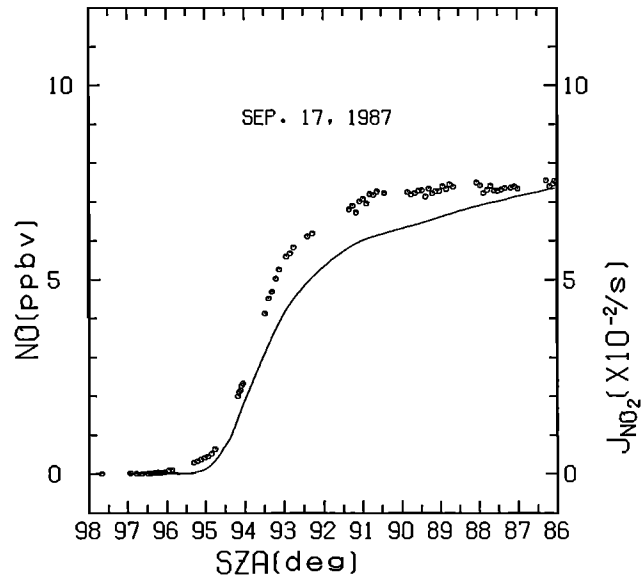

Fig. 3. Temporal variation of NO near sunrise versus SZA. The calculated photodissociation coefficient of NO₂ provided by S. Solomon (private communication, 1990) is shown as a solid line.

km. The rate of increase in NO seems to have become smaller around 0930 UT. However, there are irregular variations in the NO data, so the detailed structure of the diurnal variation of NO in the late morning is not well defined by the present data.

The second experiment, which investigated the temporal

variation of NO in the late morning hours, was launched on June 18, 1988, from the CNES balloon launching site at Gap (44.5°N, 6°E) using a 400,000-m³ balloon. The same gondola, but with the NO/NO₂ instrument for this flight, was launched at 0503 UT and reached a float altitude of 39.1 km (3.7 mbar)

at 0735 UT. It stayed at that altitude until a slow descent was initiated at around 1200 UT. The descent NO profile between 39 and 28 km measured in the afternoon has been presented by Kondo *et al.* [1989a], together with the ozone and temperature profiles. The NO_y measurements performed during the ascent at altitudes between 12 and 28 km have also been described previously [Kondo *et al.*, 1990]. The temperature and ozone mixing ratio measured by the UV photometer at float altitude were -14°C and 5.3 ± 0.2 ppmv, respectively. From a photograph taken by Meteosat II at 1200 UT, about 20% of southern France was covered with clouds. However, the region below the balloon flight path was free of thick clouds.

The NO mixing ratio measured at float altitude from 0730 until 1230 UT is shown in Figure 4. Local time was 16 ± 7 min in advance of UT during this flight. During the first half of this period the NO concentration increased slowly from about 11 to 12 ppbv, after which time it became nearly constant. By combining the data from the two flights reported here, the diurnal variation of NO near 40 km from before sunrise until past local noon has been experimentally measured.

RESULTS AND DISCUSSION

For quantitative analysis of the observed NO data, a time-dependent zero-dimensional model described by Pirre *et al.* [1989] was used. Related reaction rate coefficients appropriate for the measured temperatures were adopted from Jet Propulsion Laboratory [1987] (hereinafter *JPL* [1987]). From the mixing ratio of total reactive nitrogen ($[\text{NO}_y] = [\text{NO}] + [\text{NO}_2] + [\text{NO}_3] + 2[\text{N}_2\text{O}_5] + [\text{HNO}_3] + [\text{HO}_2\text{NO}_2] + [\text{ClONO}_2]$) at 40 and 39 km and the diurnal variation of the SZA, the temporal variation of each species can be calculated. For the partitioning between NO and NO_2 the photodissociation of NO_2 plays an important role. The NO_2 photodissociation coefficient, J_{NO_2} , has been calculated recently by Solomon *et al.* [1989]; here, values of J_{NO_2} provided by S. Solomon (private communication, 1990) have been used for SZA larger than 85° and are shown in Figure 3. The effects of multiple scattering were included in the calculation, and an albedo of 0.15 was assumed, consistent with the light cloud cover observed during both balloon flights. All other calculated results described in this paper are based on the model of Pirre *et al.* [1989].

NO Diurnal Variation

First, the temporal variation of NO has been calculated for the conditions at float altitude on September 17. The measured temperature of -27°C and an ozone mixing ratio of 5.75 ppmv (the average of the values measured by the two ozone instruments) were used at the pressure level of 2.80 mbar for the calculation. The calculated temporal variation of NO for three values of the NO_y mixing ratio (14.0, 14.5, and 15.0 ppbv) are compared with the observed values in Figure 5. The calculated NO concentration agrees with that observed to within 0.5 ppbv, or 5%. This agreement is quite good considering the accuracy of the measurements and the fluctuation in the data. But when the comparison is examined in more detail, it is noted that the observed rate of the increase in NO between 0530 and 0700 LT exceeds the calculated rate. However, in Figure 5 it can be seen that (1) the calculated initial buildup of NO at sunrise is the same for all three values of NO_y , (2) the final phase of the initial increase agrees best with an NO_y concentration of 14.0 ppbv, and (3) the measured late morning NO concentration agrees best with $\text{NO}_y = 15.0$ ppbv.

To compare in detail the first hour of increase in NO at the beginning of the morning, the calculated values of NO for

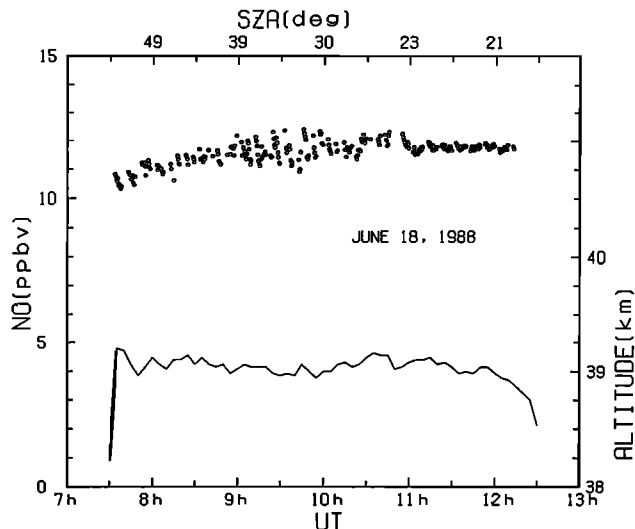

Fig. 4. The same as Figure 2, but for the observation at 39 km on June 18, 1988.

$[\text{NO}_y] = 14.5$ ppbv were compared with the observations as a function of solar zenith angle, as shown in Figure 6. In this figure it can be seen that agreement between the observed and calculated NO mixing ratio is noticeably improved by assuming

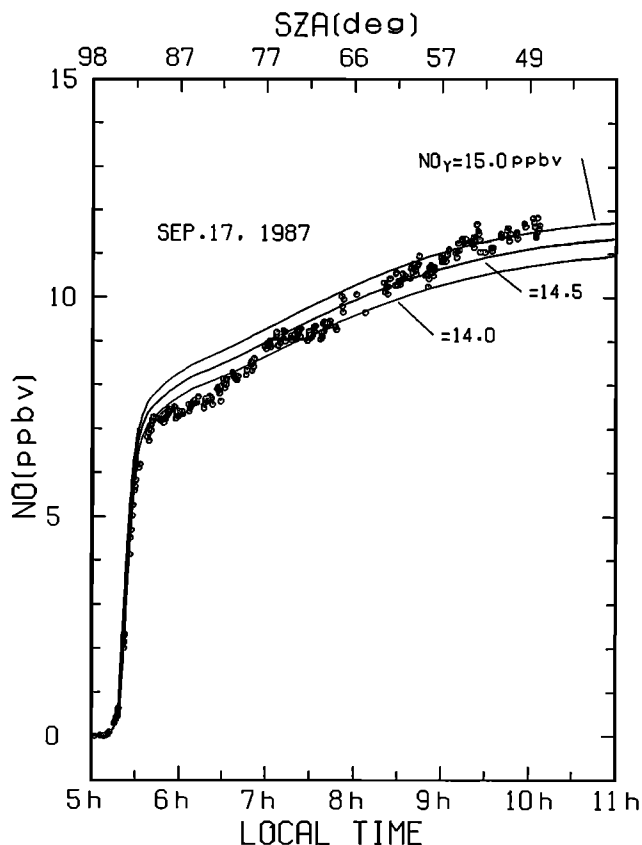

Fig. 5. Comparison of measured (circles) and computed values (solid lines) of the NO mixing ratio versus local time (LT) for the observations of September 17, 1987. Computed curves are for NO_y values of 14.0 ppbv (bottom curve), 14.5 ppbv (middle curve), and 15.0 ppbv (top curve).

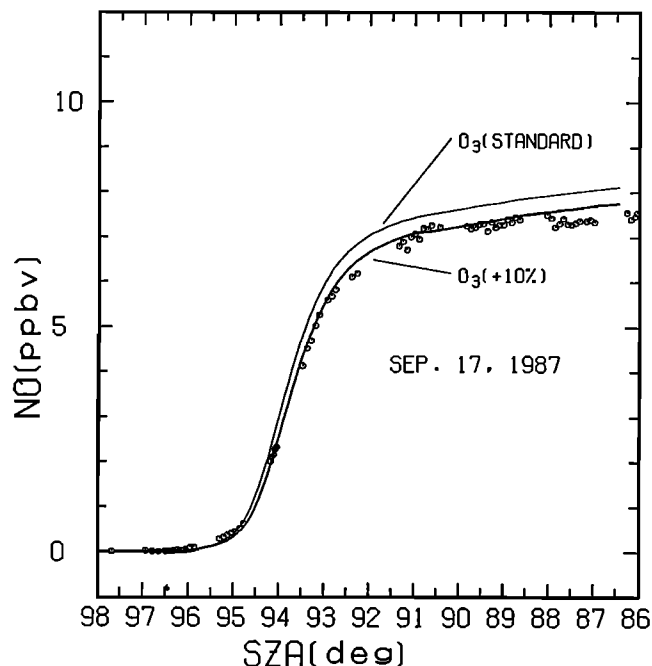
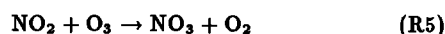

Fig. 6. Comparison of measured values (circles) and computed curves (solid line) of the NO mixing ratio near sunrise on September 17, 1987, for SZA less than 86° . For the calculation, an NO_y mixing ratio of 14.5 ppbv was assumed. The thin curve resulted from using the ozone concentration measured just before sunrise, and the thick curve resulted in an assumed average increase of 10% in the ozone concentration or the equivalent through an increase in k_5 (see text).

an ozone concentration during the previous night 10% larger than that measured just before sunrise. The change in NO during this phase is due mostly to the photodissociation of NO_2 , as investigated in more detail below using the numerical model. There is remarkable agreement between observed and calculated values of NO during the rapid increase at SZAs between 95° and 92° .

Since an assumed increase in the ozone concentration resulted in improved agreement in Figure 6, the effect of ozone on the form of the diurnal variation of NO is discussed below. The rate of increase in NO during the first few hours after sunrise depends significantly on the amount of N_2O_5 present at that time. An augmented amount of N_2O_5 would increase the rate at which NO builds up just after sunrise due to a reduced NO_x concentration and a larger production rate of NO_x through the photodissociation of N_2O_5 . N_2O_5 is formed during the night by reactions



The rate coefficient k_5 is

$$k_5 = 1.4 \times 10^{-13} \exp(-2500/T) \text{ cm}^3 \text{ s}^{-1}$$

where T is the temperature ($^\circ\text{K}$) [JPL, 1987].

The sum of the NO_3 and N_2O_5 concentrations during nighttime is governed by the following continuity equation [Flaud et al., 1983]:

$$\frac{d}{dt}([\text{NO}_3] + [\text{N}_2\text{O}_5]) = k_5[\text{NO}_2][\text{O}_3]$$

Consequently, the product $k_5[\text{O}_3]$ is expected to influence the diurnal variation after sunrise. Also it should be noted that the values of k_5 and ozone concentration that control the nighttime production rate of N_2O_5 are not those that were measured during the early morning, but rather the values that prevailed from sunset on the previous day until sunrise. The uncertainties of the ozone mixing ratio and k_5 are summarized in Table 2. The temperature measurement at float altitude has an uncertainty of 2°K . The uncertainties of the temperature of 1° and 2°K are reflected in the 4 and 9% uncertainties in k_5 . In addition, the uncertainty in the laboratory determination of k_5 is 25% for a temperature of 250°K [JPL, 1987]. The effect of the change in ozone on the diurnal variation of NO has been calculated and is shown in Figure 7a. Improvement in the agreement between measured and calculated values of the NO concentration brought about by a 10% increase in the O_3 mixing ratio is seen mainly in the region of SZAs greater than 86° . The calculated diurnal variation of NO by using k_5

TABLE 2. Uncertainties in $k_5[\text{O}_3]$

	Uncertainty %
$[\text{O}_3]$	10
$k_5(\Delta T = 1^\circ\text{K})$	4
$k_5(\Delta T = 2^\circ\text{K})$	9
$k_5(\text{absolute})$	25

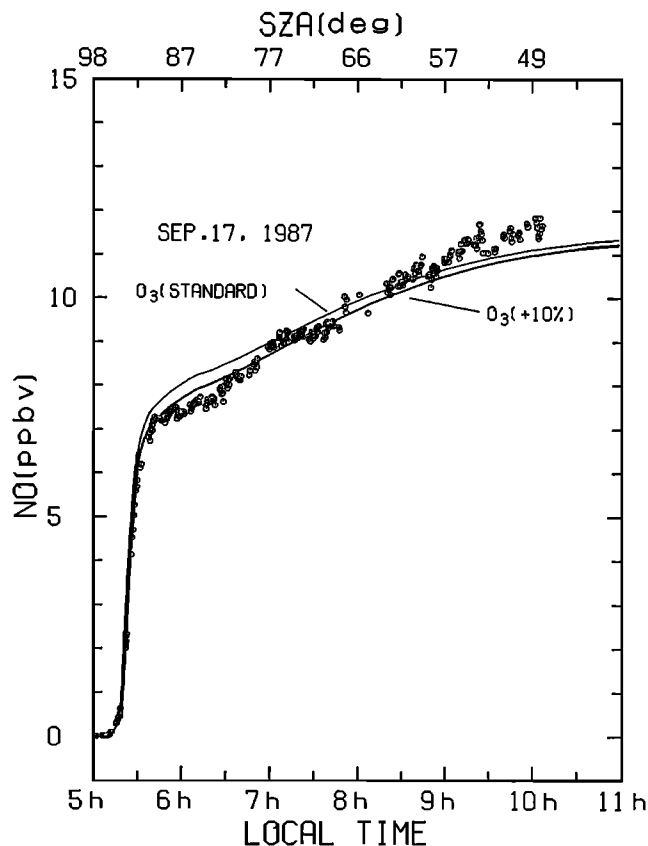

Fig. 7a. The same as Figure 6 but for all of the NO observations made at float altitude on September 17, 1987.

increased by 25% is shown in Figure 7b. In this calculation the NO_y mixing ratio was assumed to be 14.7 ppbv, the value which provides the best overall agreement between calculated and measured NO values. It can be seen that the agreement between the observed and modeled NO variations becomes improved to some extent. Since an increase in ozone concentration has similar effect to a corresponding increase in k_5 , a 10% increase in the ozone mixing ratio and 15% increase in k_5 will have an effect similar to a 25% increase in k_5 alone.

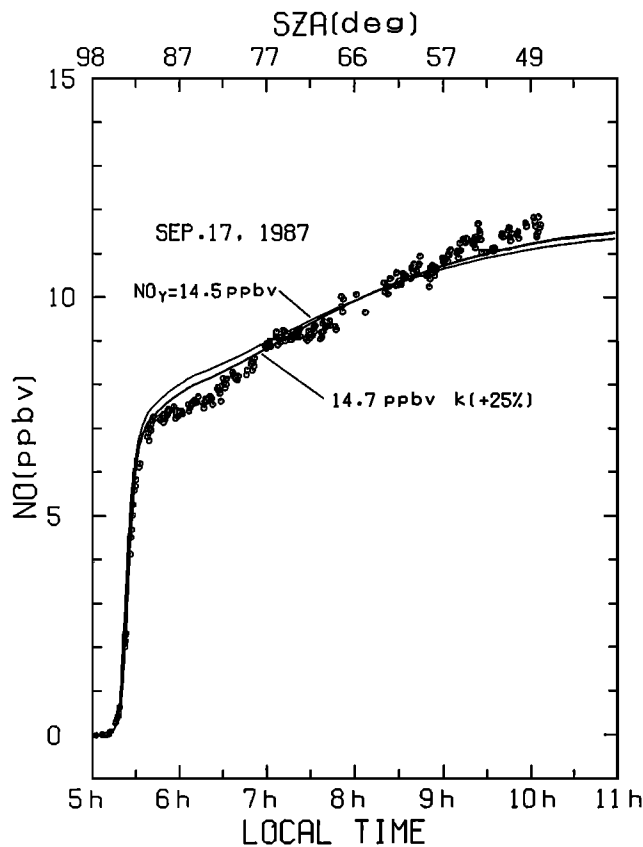

Fig. 7b. The same as Figure 7a but for the computed curve (solid line); a value of k_5 increased by 25% was assumed. For this computation, an NO_y mixing ratio of 14.7 ppbv was assumed (see text). For comparison, the standard model result is also shown.

The change in albedo can affect the NO mixing ratio through the change in the photodissociation rate of NO_2 . It was found that adoption of an albedo as large as 0.6 increases the NO mixing ratio between 0900 and 1100 LT by about 0.5 ppbv or 5%, while it causes little change in NO at hours earlier than 0730 LT. This effect increases the rate of change in NO and thus improves the agreement between the observation and the model. However, such a large albedo is quite unlikely on September 17, when a very light cloud cover was observed, as already discussed.

In summary, it can be said that the observed and modeled diurnal variations agree to within the uncertainties in the measurements of NO, ozone, and temperature and the value of k_5 .

Next, the temporal variation of NO observed at 39 km from 0800 LT to noon on June 19, 1988, is compared with that calculated. The calculation was made for a pressure of 3.77 mbar,

which was the mean float pressure level. The measured ozone mixing ratio and the temperature at this altitude used in the calculation were 5.4 ppmv and -14°C . The calculated results for $[\text{NO}_y] = 16.0, 16.5,$ and 17.0 ppbv are shown in Figure 8. It can be seen that the calculated curves agree with the observed NO concentration for $[\text{NO}_y] = 16.5$ ppbv within ± 0.5 ppbv, a value within the uncertainty of the NO measurements. The calculation predicts an NO increase of about 1 ppbv between 0800 and 1200 LT, in good agreement with the observations.

The rate of NO increase after 0800 LT and the daytime NO mixing ratio are insensitive to change in the ozone concentration of the order of 10%, as can be seen from the calculated curves in Figure 7a. Therefore, for comparison of the calculated and observed NO concentration during late morning on June 18 the effect of the uncertainties discussed above for conditions at sunrise (September 17, 1987, observations) is negligible compared to the uncertainty in the NO measurements.

The calculated temporal variation of NO, NO_2 , NO_3 , NO_2 , $= \text{NO} + \text{NO}_2 + \text{NO}_3$, N_2O_5 , and HNO_3 species for $[\text{NO}_y] = 16.5$ ppbv at 39 km on June 18 are presented in Figure 9 to show the diurnal variation of the partitioning among the NO_y family. It can be seen that the change in NO during the first hour after sunrise is caused mostly by the photodissociation of NO_2 , since the mixing ratio of NO_2 (as defined just above) changes little during this period. It can also be seen that most of the photodissociation of N_2O_5 occurs within 3 hours after sunrise. The rate of the increase in NO during this period is controlled by the rate of photodissociation of N_2O_5 and the slow shift in the NO/NO_2 ratio due to the increase in J_{NO_2}

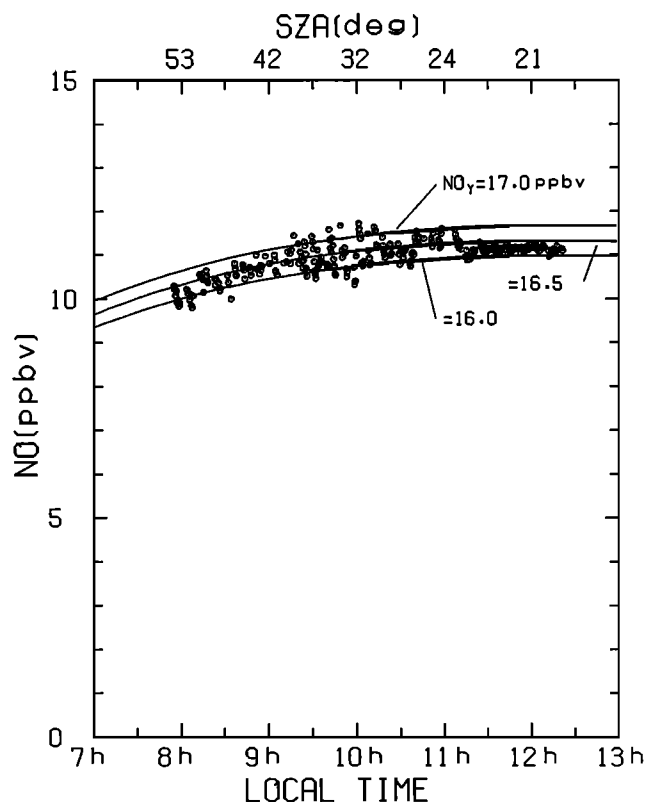

Fig. 8. Comparison of the measured (circles) and computed values (solid lines) of the NO mixing ratio for the observations of June 18, 1988. Computed curves are for NO_y values of 16.0 ppbv (bottom curve), 16.5 ppbv (middle curve), and 17.0 ppbv (top curve).

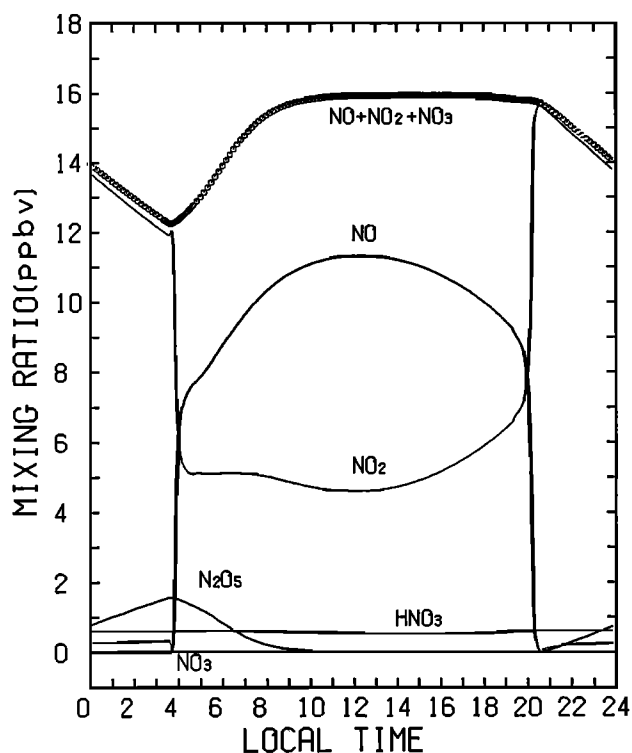

Fig. 9. Computed diurnal variation of NO, NO₂, NO₃, NO_x = NO + NO₂ + NO₃, N₂O₅, and HNO₃ for an NO_y value of 16.5 ppbv at 39 km on June 18 at 44°N.

with decreasing SZA. The HNO₃ concentration varies little, as can be seen from the figure, and the ClONO₂ concentration is negligibly small at this altitude. This model shows that the daytime NO_x concentration is very close to the total NO_y concentration and that daytime NO accounts for 70% of NO_y.

NO_y

As discussed above, the most probable values of the NO_y concentration at 40 km in September and 39 km in June are 14.5 ppbv and 16.5 ppbv, respectively. Previously, Kondo *et al.* [1989b] reported an estimated NO_y concentration of 14 ppbv at 26 km at 32°N in July 1987 from a similar comparison of the observed and modeled diurnal variation of NO. The NO_y concentration at 32.5 km can also be derived from the observed NO temporal variation at 44°N in October [Kondo *et al.*, 1988]. However, their NO values at 32.5 km have been found to be overestimated by about 25% [Kondo *et al.*, 1989b]. These revised NO values and the present model yield a derived NO_y mixing ratio of 18.5 ppbv at 32.5 km. In estimating these values of the NO_y mixing ratio from the measured NO diurnal variation, uncertainties in the calculated [NO]/[NO_y] ratio and in the measured NO mixing ratio contribute to the errors. The [NO]/[NO_y] ratio is expressed as

$$\begin{aligned} [\text{NO}]/[\text{NO}_y] &= ([\text{NO}]/[\text{NO}_x]) \cdot ([\text{NO}_x]/[\text{NO}_y]) \\ &= \{1/(1 + [\text{NO}_2]/[\text{NO}])\} \cdot ([\text{NO}_x]/[\text{NO}_y]) \end{aligned}$$

The [NO₂]/[NO] ratio is governed by the following photochemical reactions:

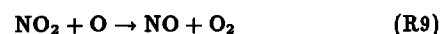
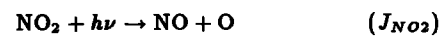
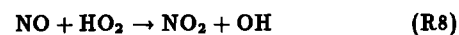
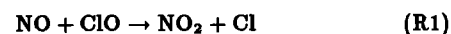
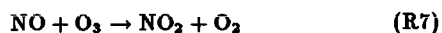

and is expressed as

$$[\text{NO}_2]/[\text{NO}] = (k_7[\text{O}_3] + k_1[\text{ClO}] + k_8[\text{HO}_2]) / (J_{\text{NO}_2} + k_9[\text{O}])$$

The uncertainties in the reaction rate coefficients and J_{NO_2} , given by JPL [1987], are shown in Table 3. Assumed values of the uncertainties in the calculated concentrations of O, ClO, and HO₂ are also given in Table 3. The indicated uncertainty in the ozone concentration is that associated with the ozone measurement. The square root sum of the weighted uncertainty of each term gives an error of 78% for the [NO]/[NO₂] ratio, leading to an error of 25% in the [NO]/[NO_y] ratio. Major species of NO_y other than NO_x are HNO₃ and N₂O₅, as indicated in Figure 9. Assuming 100% errors in estimating the concentrations of both species, the [NO_x]/[NO_y] ratio at 40 km at 0600 LT has an uncertainty of 11%, thus leading to an error of 30% in the estimate for NO_y, including the 10% NO measurement error. Similar estimates at 26 km and 32.5 km have given uncertainties in NO_y of 60% and 45%, respectively.

TABLE 3. Uncertainties in the Reaction Rate Coefficients and the Concentration of the Related Species Calculated for 40 km.

	Uncertainty %
J_{NO_2}	30
k_3	40
k_4	20
k_{14}	30
k_{15}	20
[O ₃]	10
[O]	30
[ClO]	30
[HO ₂]	50

The NO_y values discussed above are summarized in Table 4.

In Figure 10 these calculated NO_y mixing ratios are shown together with our directly measured NO_y concentrations during ascent on June 18, 1988. NO_y mixing ratios from the Atmospheric Trace Molecule Spectroscopy (ATMOS) instrument [Russell *et al.*, 1988] are also shown in Figure 10; the measurements were made on board Spacelab 3 at 30°N and 48°S in May. The ATMOS instrument determined each major species of the NO_y family by infrared absorption spectra measurements through the limb of the Earth's atmosphere. The NO_y mixing ratio measured by the ATMOS instrument near 40 km at 30°N and 48°S in May are listed in Table 5; the average of these values at 39.5 km is 15.8 ± 0.9 ppbv. This value is in very good agreement with our average NO_y value of 15.5 ± 5.0 ppbv for September and June; our June value of 16.5 ppbv at 44°N is especially close to the ATMOS May value of 16.7 ppbv at 30°N. The estimated error of the ATMOS data at 39.5 km is 13%. The agreement of our NO_y values with the ATMOS measurements indicates that the model of Pirre *et al.* [1989] presents a reasonable description of reactive nitrogen in the upper stratosphere at mid-latitudes.

The ATMOS values of NO_y agree with our direct measure-

TABLE 4. Summary of the Derived NO_y and N_2O_5 Mixing Ratio, and NO_y /osone Ratio, and the Measured O_3 Mixing Ratio

Date	Lat. °N	Temp. °K	Alt. km	NO_y ppbv	N_2O_5 ppbv	O_3 ppmv	$\text{NO}_y/\text{osone} \times 10^{-3}$
Sept. 17, 1987	44	246	40.2	14.5 ± 4.3	1.2 ± 0.4	5.75 ± 0.3	2.52 ± 0.76
June 18, 1988	44	259	39.1	16.5 ± 5.0	1.6 ± 0.6	5.40 ± 0.3	3.06 ± 0.92
Oct. 4, 1985	44	227	32.5	18.5 ± 8.4	2.2 ± 1.2	7.0 ± 0.4	2.64 ± 1.19
July 29, 1987	32	225	26.0	14.0 ± 8.5	1.9 ± 1.2	6.4 ± 0.3	2.19 ± 1.34

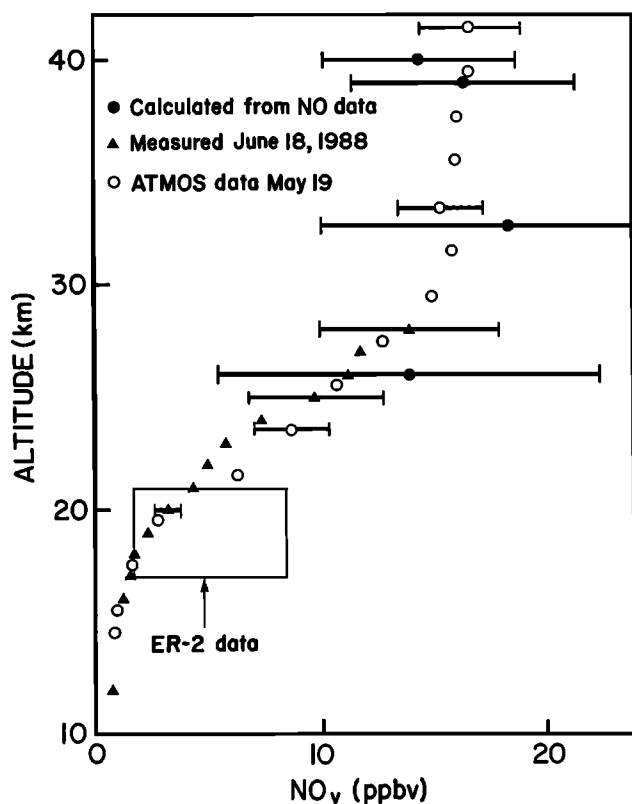

Fig. 10. Comparison of NO_y mixing ratio values from several sources. Solid circles are those obtained from the present NO observations (see Table 1), and the triangles are the direct measurements during ascent on June 18, 1988. Open circles are ATMOS data at 30°N in May [Russell *et al.*, 1988]. The large square labeled "ER 2 Data" indicates the range of values by *D. M. Murphy et al.* (unpublished manuscript, 1990).

ments at 26 km, but NO_y values estimated from the NO observations (indirect values) at 32.5 and 26 km are 2-3 ppbv larger. None of these measurements were made simultaneously, so the difference of 2-3 ppbv could be due to natural variability caused by dynamical transport.

In general, our direct NO_y measurements agree with those of the ATMOS experiment, as can be seen in Figure 10, although our values are somewhat smaller between 20 and 24 km. In the lower stratosphere, extensive observations of NO_y with a chemiluminescence NO detector combined with a gold catalytic converter have been made on board the ER 2 aircraft (*D. M. Murphy et al.*, unpublished manuscript, 1990). In Figure 10 the range of values obtained at altitudes between 17 and 21 km and between latitudes 30° and 45°N is indicated as a large

TABLE 5. NO_y Mixing Ratio

Altitude km	Mixing Ratio ppbv	
	30°N	48°S
41.5	16.7 ± 2.3	12.9 ± 1.7
39.5	16.7 ± 2.2	14.9 ± 1.2
37.5	16.2 ± 2.1	16.3 ± 1.8

From Russell *et al.*, [1988].

square. In the lower stratosphere our values are in the range of the ER 2 data but are somewhat lower than their average value.

NO_y and ozone mixing ratios have been found to be correlated quite well in the lower stratosphere (*D. M. Murphy et al.*, unpublished manuscript, 1990). The variability observed in NO_y or ozone alone is greatly reduced when presented as the NO_y/ozone ratio. For this reason the NO_y/ozone ratio can be a more useful, and probably a more meaningful parameter for comparison with other measurements or numerical models. The NO_y/ozone ratios from our simultaneous measurements of NO_y and ozone are listed in Table 4 and are shown in Figure 11. As mentioned above, NO_y was measured directly during ascent on June 18, 1988 between 12 and 28 km. The observed NO_y/ozone ratio in that altitude region has been presented previously [Kondo *et al.*, 1990]. Smoothed values of the NO_y/ozone ratio for each 1 km in altitude are shown as triangles in this figure. Above 25 km the NO_y/ozone ratio ranges between 2 and 3 times 10^{-3} . The NO_y/ozone ratio is observed to increase slightly with altitude from 20 to 40 km.

N_2O_5

As can be seen from Figure 9, the calculated N_2O_5 concentration at 39 km at the end of the night on June 18 was 1.6 ppbv. Similarly, from the model run for September 17 the estimated N_2O_5 mixing ratio just prior to sunrise at 40 km was 1.2 ppbv. The estimated uncertainty in the N_2O_5 mixing ratio is about ± 0.5 ppbv associated with uncertainties in ozone, NO_y and temperature. The N_2O_5 mixing ratio in June at 39 km derived from the model is 30% larger than that in September at 40 km. The contribution of the June/September difference in the NO_y mixing ratio to this 30% difference in the calculated N_2O_5 concentration is about 15%. The difference in stratospheric temperature between June and September of 13°K causes a 70% difference in the value of k_5 and a 60% difference in the $k_5[\text{O}_3]$ value, when the measured variation of $[\text{O}_3]$ is taken into account. This effect causes the additional 15% difference in the N_2O_5 concentration.

The NO_y mixing ratios at 32.5 and 26 km have been estimated so that the modeled diurnal variations of NO give the best fit to those observed. The N_2O_5 mixing ratios calculated by this model for these NO_y values are 2.2 ± 1.2 ppbv and 1.9 ± 1.2 ppbv, respectively. These N_2O_5 values are listed in Table 4 and are shown in Figure 12. Measurements of strato-

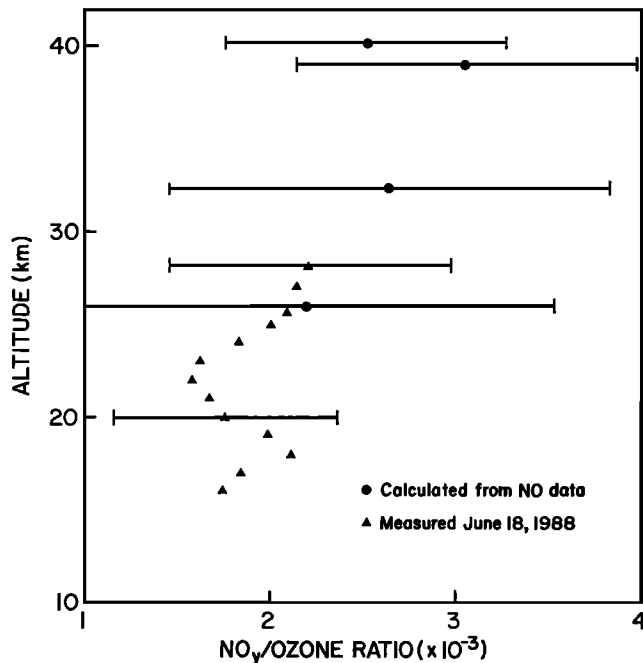

Fig. 11. Profile of the NO_y /ozone ratio. Solid circles are the values listed in Table 1. Triangles are from the measured values of NO_y and ozone during ascent on June 18, 1988. See text.

spheric N_2O_5 were first made by *Roscoe* [1982] with a pressure-modulated radiometer and were followed by the measurement of *Evans* [1986] with a cooled filter spectrometer. *Kunde et al.* [1988] obtained the predawn N_2O_5 mixing ratio from 21 to 39 km from measurements of the N_2O_5 emission spectrum on board a balloon at 32°N in September. Their values above 23 km are also shown in Figure 12, together with the ATMOS N_2O_5 data above 25 km at sunrise at 48°S in May. For the ATMOS N_2O_5 data the revised values of *Rinsland et al.* [1989] are shown. The N_2O_5 mixing ratio of *Kunde et al.* [1988] at 39 km is 1.3 ± 0.7 ppbv, and the ATMOS value at 37.4 km is 1.32 ± 0.34 ppbv. Those values agree quite well with the present N_2O_5 mixing ratio of 1.6 ± 0.6 ppbv at 39 km and 1.2 ± 0.4 ppbv at 40 km, an average mixing ratio of 1.4 ± 0.6 ppbv. It should be noted that our estimates of N_2O_5 in the upper stratosphere have relatively smaller uncertainties than those at altitudes of 26 and 32.5 km, as discussed above. Our value at 32.5 km is about 0.7 ppbv larger than the values of *Kunde et al.* [1988] and the ATMOS data, although the uncertainty in the measurements results in overlap.

From infrared emission measurements, *Blatherwick et al.* [1989] obtained an N_2O_5 concentration of 1.26 ppbv at 30 km in the early morning on July 5, at 32°N . However, due to the difference in altitude, direct comparison of this value with our estimate is difficult. At 26 km our value is again 1 ppbv larger than that of the ATMOS data, but in agreement with the mixing ratio of 2.4 ± 0.8 ppbv at 28 km by *Kunde et al.* [1988]. This disagreement can be partly explained by the difference in temperature. The average temperature at 26 km in May at 48°S is usually lower by about 12°K than in July at 30°N .

SUMMARY AND CONCLUSIONS

The temporal variation of nitric oxide during morning hours at an altitude of about 40 km was measured at 44°N in autumn and summer. The NO mixing ratio was observed to

begin a rapid increase when the SZA reached 95° . This initial rapid increase in NO for SZA between 95° and 90° was found to agree quite well with a zero-dimensional photochemical model [*Pirre et al.*, 1989] assuming a constant NO_y mixing ratio. This indicates that behavior of NO near sunrise can be explained by a rapid increase in the photodissociation rate of NO_2 . The slower increase in NO that follows in the early morning is also in agreement with the model calculation, although the observed rate of increase is somewhat larger than that calculated for the September observation. Later in the morning the agreement is better: the observed NO from 0800 LT to local noon in June showed an increase of about 1 ppbv, in excellent agreement with the model. The model indicates that this slow increase is caused mainly by the photodissociation of N_2O_5 and a slow increase in the NO/ NO_2 ratio. The concentrations of NO_y and N_2O_5 in the upper stratosphere have been estimated using the model and measured values of the NO mixing ratio. The NO_y mixing ratio of 15.5 ± 5.0 ppbv estimated for 39 and 40 km agrees quite well with the ATMOS measurements [*Rinsland et al.*, 1989]. The N_2O_5 mixing ratio derived from the model, 1.4 ± 0.6 ppbv, is also in agreement

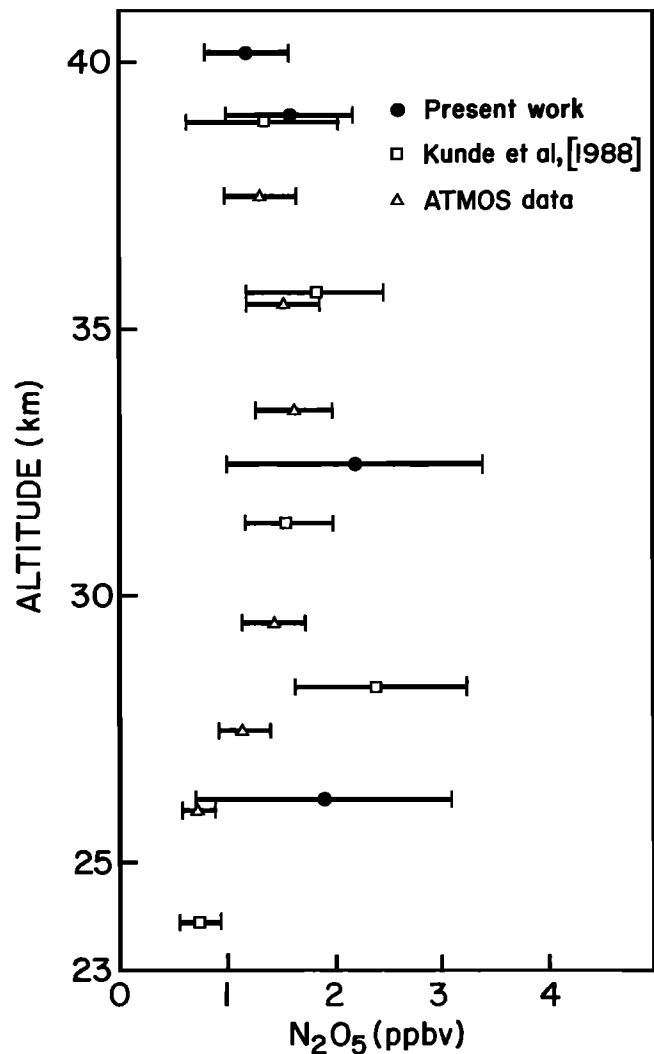

Fig. 12. Comparison of N_2O_5 mixing ratios. Solid circles are our estimates given in Table 1. Triangles are the ATMOS measurements [*Rinsland et al.*, 1989], and the squares are the values by *Kunde et al.* [1988].

with the infrared measurements by Kunde *et al.* [1988] and with the ATMOS data [Rinsland *et al.*, 1989].

In conclusion, it can be said that the present measurement of NO is in reasonable agreement with the photochemical model. An observed increase in NO during the early morning hours is somewhat larger than that predicted. However, the differences between the observed and predicted values are within the uncertainties in the measurements of NO, ozone, and temperature, and in the reaction rate coefficient of R5. The NO_y and N₂O₅ mixing ratios, determined from the model using the present NO measurements, agree well with other recent observations.

Acknowledgments. We wish to thank CNES for its excellent balloon operations and logistic support at Aire sur l'Adour and Gap. The two balloon flights were supported by CNES with participation of Service d'Aéronomie, CNRS. S. Solomon generously provided the computed results of J_{NO2} used in the present calculation. Thanks are due also to D. M. Murphy and D. W. Fahey, who kindly showed us their paper before publication. We wish to thank N. Toriyama, M. Kanada, H. Jindo, C. Bernard, and J. Gilbert for their technical assistance in the preparation of the balloon-borne experiments. Y. K. acknowledges support by the Ministry of Education, Science and Culture. The work of W. R. S. and J. R. B. was supported in part by NASA Grant NAG9-213 and by the Texas Higher Education Coordinating Board. The calculations were made on the CIRCE at Orsay, France.

REFERENCES

- Aimedieu, P., Measurement of the vertical ozone distribution by means of an *in situ* gas phase chemiluminescence ozonometer during the intercomparison ozone campaign, GAP, France, June 1981, *Planet. Space Sci.*, **31**, 743-749, 1983.
- Aimedieu, P., and J. Barat, Instrument to measure stratospheric ozone with high resolution, *Rev. Sci. Instrum.*, **54**, 432-437, 1981.
- Aimedieu, P., W. A. Matthews, W. Attmannspacher, R. Hartmannsgruber, J. Cisneros, W. Komhyr, and D. E. Robbins, Comparison of *in situ* stratospheric ozone measurements obtained during the MAP/GLOBUS 1983 campaign, *Planet. Space Sci.*, **35**, 563-585, 1987.
- Blatherwick, R. D., D. G. Murcray, F. H. Murcray, F. J. Murcray, A. Goldman, G. A. Vanasse, S. T. Massie, and R. J. Cicerone, Infrared emission measurements of morning stratospheric N₂O₅, *J. Geophys. Res.*, **94**, 18337-18340, 1989.
- Bollinger, M. J., R. E. Sievers, D. W. Fahey, and F. C. Fehsenfeld, Conversion of nitrogen dioxide, nitric acid, and *n*-propyl nitrate to nitric oxide by gold-catalyzed reduction with carbon monoxide, *Anal. Chem.*, **55**, 1980-1986, 1983.
- Evans, W. F. J., Observation of the 8- μ m N₂O₅ thermal emission feature in the stratosphere, *Appl. Opt.*, **25**, 1866-1868, 1986.
- Fahey, D. W., C. S. Eubank, G. Hübler, and F. C. Fehsenfeld, Evaluation of a catalytic reduction technique for the measurement of total reactive odd-nitrogen NO_y in the atmosphere, *J. Atmos. Chem.*, **3**, 435-468, 1985.
- Flaud, J.-M., C. Camy-Peyret, D. Cariolle, J. Laurent, and G. M. Stokes, Daytime variation of atmospheric NO₂ from ground-based infrared measurements, *Geophys. Res. Lett.*, **10**, 1104-1107, 1983.
- Isaksen, I. S. A., and F. Stordal, Ozone perturbations by enhanced levels of CFCs, N₂O, and CH₄: A two-dimensional diabatic circulation study including uncertainty estimates, *J. Geophys. Res.*, **91**, 5249-5263, 1986.
- Jet Propulsion Laboratory, Chemical kinetics and photochemical data for use in stratospheric modeling, *Report, Jet Propulsion Lab., Pasadena, Calif.*, 87-41, 1987.
- Kondo, Y., A. Iwata, M. Takagi, and W. A. Matthews, Balloon-borne chemiluminescent sonde for the measurement of tropospheric and stratospheric nitric oxide, *Rev. Sci. Instrum.*, **55**, 1328-1332, 1984.
- Kondo, Y., W. A. Matthews, A. Iwata, and M. Takagi, Measurement of nitric oxide from 7 to 32 km and its diurnal variation in the stratosphere, *J. Geophys. Res.*, **90**, 3813-3819, 1985.
- Kondo, Y., W. A. Matthews, P. Aimedieu, and D. E. Robbins, Diurnal variation of nitric oxide at 32 km: Measurements and interpretation, *J. Geophys. Res.*, **93**, 2451-2460, 1988.
- Kondo, Y., P. Aimedieu, W. A. Matthews, W. R. Sheldon, and J. R. Benbrook, Profiles of nitric oxide in the upper stratosphere, *Geophys. Res. Lett.*, **16**, 1379-1382, 1989a.
- Kondo, Y., A. Iwata, M. Pirre, R. Ramarosan, C. Delannoy, W. A. Matthews, M. Koike, and K. Suzuki, Diurnal variation of nitric oxide at 26 km, *Geophys. Res. Lett.*, **16**, 867-870, 1989b.
- Kondo, Y., N. Toriyama, W. A. Matthews, and P. Aimedieu, Calibration of the balloon-borne NO instrument, *J. Geomagn. Geoelectr.*, **41**, 507-523, 1989c.
- Kondo, Y., P. Aimedieu, W. A. Matthews, W. R. Sheldon, and J. R. Benbrook, A mid-latitude balloon-borne observation of total odd nitrogen, *Geophys. Res. Lett.*, **17**, 73-76, 1990.
- Kunde, V. G., J. C. Brasunas, W. C. Maguire, J. R. Herman, S. T. Massie, M. M. Abbas, L. W. Herath, and W. A. Shaffer, Measurement of nighttime stratospheric N₂O₅ from infrared emission spectra, *Geophys. Res. Lett.*, **15**, 1177-1188, 1988.
- McElroy, M. B., and R. J. Salawitch, Changing composition of the global stratosphere, *Science*, **243**, 763-770, 1989.
- Pirre, M., R. Ramarosan, J. P. Naudet, and P. Rigaud, Altitude distribution of stratospheric NO₃, 2, comparison of observation with model, *J. Geophys. Res.*, **94**, 6383-6388, 1989.
- Ridley, B. A., and H. I. Schiff, Stratospheric odd nitrogen: Nitric oxide measurements at 32° N in autumn, *J. Geophys. Res.*, **86**, 3167-3172, 1981.
- Ridley, B. A., M. McFarland, J. T. Bruin, H. I. Schiff, and J. C. McConnell, Sunrise measurements of stratospheric nitric oxide, *Can. J. Phys.*, **55**, 212-221, 1977.
- Rinsland, C. P., G. T. Toon, C. B. Farmer, R. H. Norton, and J. S. Namkung, Stratospheric N₂O₅ profiles at sunrise and sunset from further analysis of the ATMOS/ Spacelab 3 solar spectra, *J. Geophys. Res.*, **94**, 18341-18349, 1989.
- Robbins, D. E., Balloon *in situ* measurements of ozone with the NASA-JSC UV photometer, in *Atmospheric Ozone, Proceedings of the Quadrennial Ozone Symposium, Halkidiki, Greece*, edited by C. S. Zerofos and A. Ghazi, D. Reidel, Hingham, Mass., 460-464, 1985.
- Robbins, D., et al., Ozone measurements from the balloon intercomparison campaign, *J. Atmos. Chem.*, **10**, 181-218, 1990.
- Roscoe, H. K., Tentative observations of stratospheric N₂O₅, *Geophys. Res. Lett.*, **9**, 901-902, 1982.
- Roscoe, H. K., B. J. Kerridge, L. J. Gray, R. J. Wells, and J. A. Pyle, Simultaneous measurements of stratospheric NO and NO₂ and their comparison with model predictions, *J. Geophys. Res.*, **91**, 5404-5419, 1986.
- Russell, J. M., III, C. B. Farmer, C. P. Rinsland, R. Zander, L. Froidevaux, G. C. Toon, B. Gao, J. Shaw, and M. Gunson, Measurements of odd nitrogen compounds in the stratosphere by the ATMOS experiment on Spacelab 3, *J. Geophys. Res.*, **93**, 1718-1736, 1988.
- Shimazaki, T., The photochemical time constants of minor constituents and their families in the middle atmosphere, *J. Atmos. Terr. Phys.*, **46**, 173-191, 1984.
- Solomon, S., R. W. Sanders, M. A. Carroll, and A. L. Schmeltekopf, Visible and near-ultraviolet spectroscopy at McMurdo station, Antarctica, 5, Observation of the diurnal variations of BrO and OCIO, *J. Geophys. Res.*, **94**, 11393-11403, 1989.

P. Aimedieu, Service d'Aéronomie, Centre National de la Recherche Scientifique, P. O. Box 3, 91371 Verrières-le-Buisson, CEDEX, France.

J. R. Benbrook and W. R. Sheldon, Department of Physics, University of Houston, Houston, TX 77204-5504.

A. Iwata and Y. Kondo, Solar-Terrestrial Environment Laboratory, Nagoya University, 3-13 Honohara, Toyokawa, 442, Japan.

W. A. Matthews, Department of Scientific and Industrial Research, Physical Sciences, Lauder 9182, Central Otago, New Zealand.

M. Pirre and T. C. Ramarosan, Laboratoire de Physique et Chimie de l'Environnement, Centre National de la Recherche Scientifique, 45071, Orléans, France.

(Received April 23, 1990;
revised August 20, 1990;
accepted September 6, 1990)