



HAL
open science

The ISL Langmuir probe experiment processing onboard DEMETER: Scientific objectives, description and first results

J.-P. Lebreton, S. Stverak, P. Travnicek, M. Maksimovic, D. Klinge, S. Merikallio,
Dominique Lagoutte, B. Poirier, P.-L. Blelly, Z. Kozacek, et al.

► **To cite this version:**

J.-P. Lebreton, S. Stverak, P. Travnicek, M. Maksimovic, D. Klinge, et al.. The ISL Langmuir probe experiment processing onboard DEMETER: Scientific objectives, description and first results. *Planetary and Space Science*, 2006, 54 (5), pp.472-486. <10.1016/j.pss.2005.10.017>. <insu-02879839>

HAL Id: insu-02879839

<https://insu.hal.science/insu-02879839v1>

Submitted on 9 Jun 2023

HAL is a multi-disciplinary open access archive for the deposit and dissemination of scientific research documents, whether they are published or not. The documents may come from teaching and research institutions in France or abroad, or from public or private research centers.

L'archive ouverte pluridisciplinaire **HAL**, est destinée au dépôt et à la diffusion de documents scientifiques de niveau recherche, publiés ou non, émanant des établissements d'enseignement et de recherche français ou étrangers, des laboratoires publics ou privés.



HAL Authorization

The ISL Langmuir probe experiment processing onboard DEMETER: Scientific objectives, description and first results

J.-P. Lebreton^{a,*}, S. Stverak^{b,c}, P. Travnicek^b, M. Maksimovic^c, D. Klinge^a, S. Merikallio^a,
D. Lagoutte^d, B. Poirier^d, P.-L. Blelly^d, Z. Kozacek^e, M. Salaquarda^e

^aResearch and Scientific Support Department, ESA/ESTEC, SCI-SB, Keplerlaan 1, 2200 AG Noordwijk, The Netherlands

^bIAP, Prague, Czech Republic

^cLESIA & CNRS, Observatoire de Paris-Meudon, France

^dLPCE/CNRS, 3A Avenue de la Recherche Scientifique, 45071 Orléans cedex 2, France

^eCSRC, Brno, Czech Republic

The DEMETER Langmuir probe experiment, called “Instrument Sonde de Langmuir” (ISL), has been designed for in situ measurements of the bulk parameters of the ionospheric thermal plasma. The ISL instrument is comprised of two sensors: (i) a classical cylindrical sensor and (ii) a spherical sensor with its surface divided in seven segments: six spherical caps electrically isolated and the rest of the sphere which is used as a guard electrode. The two main parameters measured by ISL are the electron density and temperature; they are obtained with a 1 s time-resolution. In addition, the ion density and its variation can be derived from the current-voltage characteristics of the probe, but it requires an a-priori knowledge of the ion composition and a more sophisticated processing than the one currently implemented. The novel design for the spherical sensor has been called the segmented Langmuir probe (SLP). The SLP current can be measured individually on each of the seven segments, thus providing angular sensitivity to the ram direction of the incoming ion flow. The SLP was flown for the first time onboard the DEMETER satellite for in-flight validation of this novel concept, but the main sensor used routinely during the mission is the cylindrical probe. The design of the instrument and the analysis technique for the cylindrical probe are described. A brief description of the SLP and of its capabilities is provided. An overview of the currently available ISL data products on the DEMETER Mission Science Data Centre is given. Selected examples of some “classical” ionospheric features as being observed by ISL are discussed.

Keywords: Ionospheric plasma; Perturbations; Electron density; Temperature

1. Introduction

The global behaviour of the upper atmosphere and particularly of the ionosphere depends on the amount of solar radiation impinging on it. Daily and seasonal variations are reasonably well modelled in current ionosphere models. It is well known that there are natural perturbations in the ionospheric plasma connected with magnetic storms, particle precipitation from the radiation belts, etc., but no model exists that allows to predict such

perturbations. Although there is observational evidence that solid-earth events such as earthquakes and volcanic activity generate atmospheric perturbations by direct coupling between the perturbed solid-earth surface and the atmosphere, the mechanisms of seismicity–ionosphere coupling are poorly understood. Correlations between tropospheric and ionospheric parameter variations have been observed for almost 50 years (Bauer, 1957; Bauer, 1958a, b), and similar mechanisms may be at work during a seismic event. Care must be exercised not to interpret these natural effects as seismogenic events as discussed, for example, by Afonin et al. (1999). The main scientific objectives of DEMETER (detection of electro-magnetic

*Corresponding author. Tel.: +31 71 565 3600; fax: +31 71 565 4697.
E-mail address: jean-pierre.lebreton@esa.int (J.-P. Lebreton).

emissions transmitted from earthquake regions) are to study the disturbances induced in the Earth ionosphere by seismic and by volcanic activity (Parrot et al., 2005). The second objective of DEMETER is the global monitoring of the Earth’s electromagnetic environment and the study of the effects of the anthropogenic activities on the ionosphere. One possible mechanism, often invoked, is that the upward propagating atmospheric perturbations couple with the ionosphere, and produce a detectable perturbation in the ionospheric parameters (Ondoh, 1999).

The specific scientific objectives of the DEMETER Langmuir Probe Instrument (ISL: Instrument Sonde de Langmuir) are to map the bulk plasma parameters (primarily electron density and temperature) and to study their variations associated with solid-earth events and other sources of perturbations. ISL is a Langmuir probe swept in voltage. A complete voltage sweep is performed in 1 s, thus allowing to obtain a current–voltage (I – V) characteristic every second. Bulk plasma parameters extracted from the analysis of the I – V characteristics are obtained with 1 s time resolution, corresponding to about 7 km spatial resolution on the 700 km altitude DEMETER orbit. ISL is also capable of monitoring the spacecraft potential and its variations with a time resolution of better than 100 ms. Here, we provide a description of the ISL instrument and illustrates the instrument capabilities to study ionospheric perturbations. In this preliminary paper, no attempt will be made to correlate the ionospheric perturbations observed with seismic events. A proper study, that will be undertaken once sufficient data has been accumulated, will be based on a statistical evaluation of the large amount of data that DEMETER is expected to acquire over its lifetime (currently planned for 2 years). This paper should be seen as an overall description of the ISL instrument capability and illustrating the ISL data products available on the server of Mission Science Data Centre after routine analysis. However, due to the inherent difficulty to perform routine processing of Langmuir Probe raw data, it is highly advisable to refer to the raw data for a detailed investigation of the observed effects.

In Sections 2 and 3 we describe in detail the ISL instrument design and we provide an overview of its flight operations. In Section 4 we present the data analysis method and describe briefly the ISL data products available to the DEMETER guest investigators through the Mission Science Data Centre server (Lagoutte et al., 2005). Examples of the preliminary ISL scientific results are described in Section 5. Concluding remarks are given in Section 6.

2. The ISL instrument description

2.1. Background information on the Langmuir probe and specifically about ISL

A Langmuir Probe (LP), in its simple form, is a conductor immersed in a plasma with a bias voltage

applied to it. The principle of the measurement technique is to vary the bias voltage and to measure the current collected as a function of the applied voltage, i.e. to acquire the current-voltage (I – V) characteristic of the probe. The analysis of the I – V characteristics provides information concerning the plasma density and temperature. The Langmuir Probe has been extensively used in space plasma diagnostic for more than 40 years (for a recent review, see for instance Brace, 1996; see also Brace et al., 1971, 1973; Bering et al., 1973; Chapkunov et al., 1976). When a conductor immersed in a plasma is biased, it acquires a space charge based on the relative flux of electrons and ions to the conductor. In a typical ionospheric plasma, in addition to the ambient ions and electrons, photoelectron and secondary particles emitted by the probe surface contribute to the overall current collected by the probe.

When the bias voltage is negative, the probe collects an ion current and repels electrons from the ambient plasma. Conversely, for a positive voltage, it collects an electron current and repels ions. The response of the LP is obtained by acquiring the I – V characteristic, much in the same way as we obtain the I – V characteristic of a diode. The analysis of the I – V characteristic provides the following plasma parameters, with their expected values along the DEMETER orbit indicated for reference:

- electron density (N_e): 10^8 – 5.10^{11} m^{-3} ,
- electron temperature (T_e): 600–10000 K,
- ion density (N_i): (note that it requires knowledge of the ion composition and of the effective ion collection area): same as N_e ,
- spacecraft potential (V_s): $\sim \pm 3\text{V}$.

A standard LP sensor is a single electrode which can be either a plane, a cylindrical, or a spherical electrode. Under ionospheric conditions, a Langmuir Probe is typically biased within the range ± 5 volts with respect to the satellite body, i.e. the virtual electrical ground. A typical I – V characteristic is shown in Fig. 1, in both a linear–linear and linear–log scale. The principle theory of the LP is well established when the plasma conditions are such that the Debye Length is much larger than the dimensions of the electrode. Then, the so-called Orbit-Motion-Limited theory applies for calculating the I – V response of the LP (Langmuir and Moth-Smith, 1924). A numerical solution has been developed for a non-flowing thermal plasma by Laframboise (1966). No complete theory exists for calculating the response of a LP under ionospheric conditions, which includes magnetic field effects and the bulk motion of the plasma. Approximate theories can however be used under “ideal” plasma conditions, i.e. Maxwellian distributions, that allow analyzing the probe response and retrieving the plasma parameters with acceptable accuracy ($\pm 15\%$ for T_e and $\pm 30\%$ for N_e are generally accepted numbers for a Langmuir probe). It should also be noted that, in addition to the relative drift effects between the plasma and the sensor (due to orbital

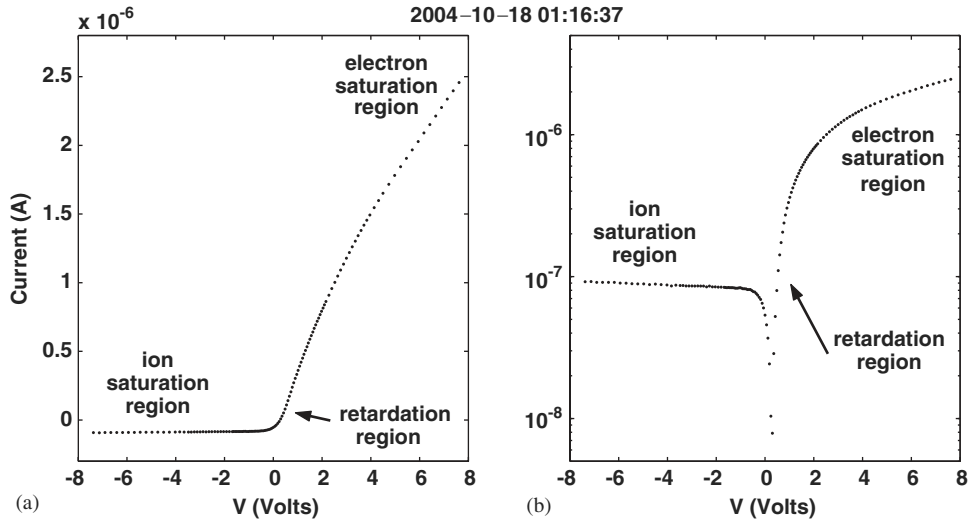

Fig. 1. Typical $I-V$ characteristic of a Langmuir probe. In both plots, the bias voltage is on a linear scale. In the left plot, the current is on a linear scale, while it is on a logarithm scale on the right plot.



Fig. 2. Overview of the DEMETER Langmuir Probe instrument which is comprised of two Langmuir probe sensors: a cylindrical sensor (diameter 0.6 cm, length 5 cm) and a segmented spherical sensor (sphere diameter 4 cm).

motion) and magnetic field effects, the presence of photoemission on the sunlit side can complicate the analysis of the response of a Langmuir Probe and affect the accuracy of the retrieval of the main plasma parameters.

The DEMETER ISL instrument is comprised of two electrodes: (i) a cylindrical electrode and (ii) a spherical electrode whose surface is divided in segments electrically

isolated from each other. This second kind of detector has been named a segmented Langmuir probe (SLP). The SLP is a new concept developed for deriving the bulk velocity of the plasma in addition to the routinely measured electron density and temperature. An overview of the ISL instrument is shown in Fig. 2. The two sensors are attached to an electronics box that is housing the multi-channel $I-V$ converter and the voltmeter for satellite

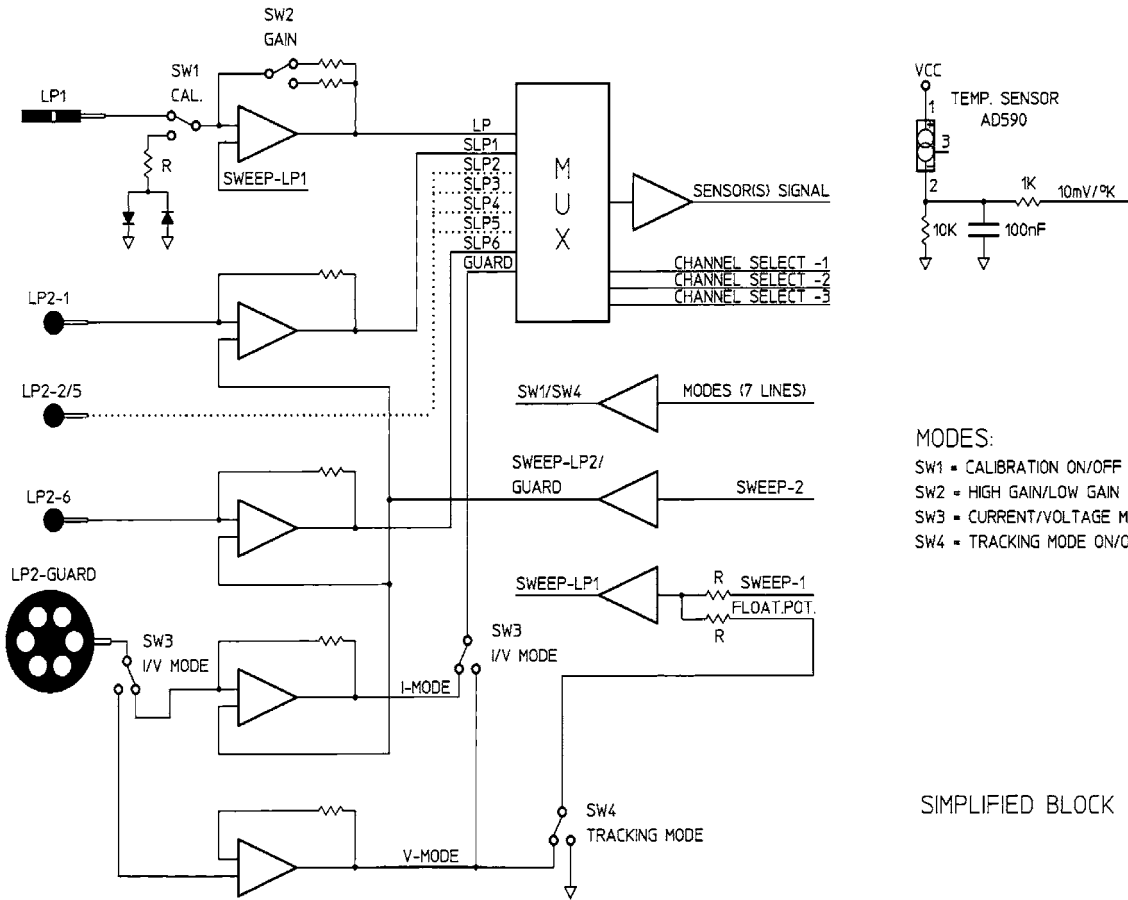

Fig. 3. ISL Functional block diagram.

potential measurement using the spherical sensor in V-mode. The functional block diagram of ISL is shown in Fig. 3.

2.2. The double probe effect

The LP sensor is biased with respect to the satellite body. This technique is however subject to the capability of the satellite body itself to collect the same amount of return current (of opposite charge) for providing a stable potential reference during the $I-V$ sweep. We call this the double probe effect. When the LP is biased negatively and is collecting ions, the spacecraft body collects an equivalent current of electrons. Conversely, when the LP is biased positively and collects electrons, the spacecraft body collects an equivalent ion current. The potential of the spacecraft is forced to adjust itself in response to the LP bias to collect the required return current. Because ion mobility is much smaller than electron mobility, it requires that the collecting area of the spacecraft be much larger (of the order of 100 times or more) than the collecting surface of the electrode for the spacecraft potential not to be affected by the LP bias. But on the other hand, the deployed collector surface of the LP sensor must be large enough so as to ensure that the minimum collected current is always above the sensitivity threshold of the $I-V$

converter. Spacecraft potential disturbances are also a source of interference for electric-field sensors (ICE, Berthelier et al., this issue) and low energy plasma instrument (IAP, Berthelier et al., this issue). The small dimension of the DEMETER spacecraft posed a special challenge for meeting the conflicting requirements described above. In order to minimize possible spacecraft potential disturbances induced by the sweeping of the Langmuir probe, a special operating mode was designed to allow the use of the ISL collectors in a double Langmuir probe configuration. Initial in-flight interference tests did indeed show the anticipated effects on the ISL sweeps on the electric-field instrument response, and created spurious transients when the LP sensors were biased in the widest range available (± 7.6 V). The interferences have been significantly reduced since the Probe is operated with a reduced sweep (± 3.8 V), (Berthelier, private communication, 2005).

2.3. The ISL sensor design

The main ISL sensor (LP1) is a guarded cylinder with a diameter of 3 mm and a length of 5 cm (7.5 cm with the guard). In order to be able to fully characterize the perturbation of the satellite potential during a LP1 sweep, the ISL instrument comprises a second probe (LP2) that

can be used either in V-mode (satellite potential measurement) or I-mode (to be used as a classical Langmuir probe). This function could, in principle, be fulfilled by a single electrode LP2. However, here LP2 is a spherical probe whose surface is comprised of six small spherical caps, the rest of the sphere being used as the guard (segmented Langmuir probe concept). The sensors are built in titanium, and coated with titanium-nitride (TiN). TiN is considered as an excellent coating that provides a good uniformity of the probe's material work-function to a few mV over the entire surface of the LP sensors (Wahlström et al., 1992), an essential characteristic for reliable plasma diagnostic in the cold ionospheric plasma. A similar surface treatment was applied to the Cassini Orbiter Langmuir probe instrument and gives excellent results (Gurnett et al., 2004).

2.4. ISL accommodation on the spacecraft

ISL is mounted on a boom (Fig. 4) which was successfully deployed a few days after the launch (Cussac et al., this issue). This allows the ISL sensors to be sufficiently outside the sheath of the spacecraft body, hence to have access to the unperturbed plasma during the routine operations.

3. ISL electronics design and modes of operation

3.1. ISL electronics design

ISL is controlled through the main BANT unit (Parrot et al., 2005). BANT generates the sweep bias (max ± 7.6 V), and performs the analog-to-digital conversion of the output of the $I-V$ converters and generates the telemetry data packets. The sweep bias voltage can either be applied

to LP1 or to each of the seven segments of LP2, but not to both sensors simultaneously. When LP1 is used in $I-V$ mode, the LP2 guard is used to measure the spacecraft potential. A temperature sensor is placed inside the electronics box to allow temperature measurement of the $I-V$ converters for post-flight calibration (temperature drift compensation) of the data. At the time of this writing, the calibration has not been completed. The lack of a complete calibration does not affect noticeably the determination of the electron parameters. It may affect more significantly the ion density measurements as the current involved in the ion saturation region is typically 100 times lower than the current in the retardation and the electron saturation regions.

3.2. Operational modes

ISL may be operated in five different operational modes which are described below.

3.2.1. Mode ISL1-1: LP1 symmetric sweep

During a probe sweep which lasts 1 s, 128 bias voltage steps are applied to the collector and the current measured at each step. The sweep can be selected out of six options, which allow either a linear sweep of different amplitude, a sweep with variable sweep increments, or a fixed bias as indicated in the Table 1. In this mode, the sweep is centered around the spacecraft potential reference, and the guard electrode of LP2 is used as a potential probe (sampling every 100 ms). ISL1-1 is the prime mode used routinely with either Table B1 or B2.

3.2.2. Mode ISL1-2: LP1 offset sweep

ISL1-2 is identical to ISL1-1, except that BANT applies a DC voltage offset to the LP1 sweep equal in amplitude

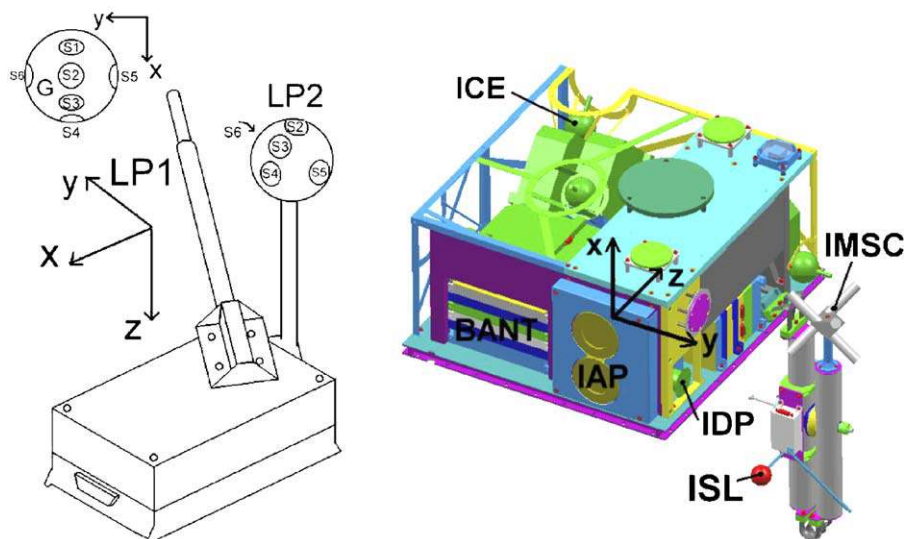

Fig. 4. Accommodation of the ISL instrument on DEMETER. ISL is mounted on the first segment of the deployable boom, which is illustrated here in the stowed position. The boom was successfully deployed a few days after launch.

Table 1

Six tables are available for programming the sweep characteristics of each of the two ISL sensors

Sweep type	Step No	Step size	Voltage range
B1	0...127	120 mV	± 7.62 V
B2	0...127	60 mV	± 3.81 V
B3	0...127	30 mV	± 1.92 V
	0...14	240 mV	
	15...17	180 mV	
	18...32	120 mV	
	33...96	60 mV	
	97...111	120 mV	
	112...114	180 mV	
	115...127	240 mV	± 7.62 V
B4	0...14	120 mV	± 3.81 V
	15...17	90 mV	
	18...32	60 mV	
	33...96	30 mV	
	97...111	60 mV	
	112...114	90 mV	
	115...127	120 mV	
	0...127	0 mV	Fixed voltage in range ± 7.62 V

The first three tables (B1, B2, B3) provide the capability to sweep ISL in linearly spaced steps. B4 and B5 provide the capability to sweep ISL with steps of different increment; a smaller increment is used around the transition region. Table B6 provides the capability to keep the ISL sensor at a fixed potential. Note that Tables B1, B2, B3 are fixed. Tables B4, B5, B6 can be reprogrammed in flight.

but reversed in sign to the spacecraft potential measured by LP2 prior to the start of each sweep. This mode allows in principle to better center the $I-V$ characteristic (when a reduced sweep amplitude is used as in Table B3) around the transition region. The guard electrode of LP2 is also used as a potential probe (sampling every 100 ms). This mode is not routinely used as the plasma potential variations along the orbit are compatible with operating ISL in Mode ISL1-1 and Table B3.

3.2.3. Mode ISL1-3: LP1 sweep wrt LP2

In this mode, the LP1 bias is applied with respect to LP2. In other words, the double-probe concept is applied to LP1-LP2. The potential induced on LP2 is measured every 100 ms. This mode was designed in order to allow operating the Langmuir probe in sweep mode with minimum perturbation to the spacecraft potential. It however requires the development of a special algorithm to retrieve the plasma parameters from the LP1 $I-V$ characteristic; furthermore its advantages over the ISL1-1 or the ISL1-2 modes were not clearly demonstrated during the in-flight payload commissioning activities. This mode was only used during the in-flight commissioning.

3.2.4. Mode ISL2: LP2 sweep

In this mode, LP2 is swept and used as a classical Langmuir Probe. A subcycle is comprised of eight $I-V$ sweeps. During the first seven sweeps, the current is

cyclically measured on the six spherical caps in turn and then on the guard of LP2 for each bias step. During the 8th cycle, the $I-V$ characteristic of LP1 is acquired. No floating potential measurements are made during this mode as LP1 was not designed to be used as a potential probe.

3.2.5. Mode ISL3: probe surface state control

ISL3 is used to monitor the probe surface cleanliness and its evolution over the mission duration. In this mode, either LP1 or one of the seven LP2 segments is selected. A special sweep subcycle is applied to the selected electrode. A sweep subcycle is comprised of a series of six sawtooth sweeps of variable duration: 250, 250, 500, 1000, 2000, and 4000 ms. An example of the ISL3 measurements is shown in Fig. 5. The ISL3 mode is regularly used during the mission to monitor the evolution of the surface properties of the probe sensors. No significant variation has been observed after nine months in orbit. This confirms that the TiN surface treatment is chemically stable in the space environment.

4. Data analysis method

In this section, we review the basic equations that govern the current collection by a Langmuir Probe in the ionosphere. The study of a Langmuir Probe response in an ionospheric plasma is a very difficult problem of a charged probe in a flowing magnetized plasma. Whereas a satisfactory theory exists for a probe in a thermal non-flowing plasma, no complete theory exists that takes into account plasma flow and magnetic fields effects. In practice, the existing approximate formulation of the current collected is adequate to obtain plasma parameters, and their variation with good accuracy. In this paper, we only consider the current contribution from the background plasma electrons and ions. The effects of the photoelectrons, of secondary emission and of the magnetic field are not considered at this stage. Those effects will be addressed in a further study.

4.1. Introduction

The current balance on the probe is governed by the following relation:

$$I_t = I_e + I_i + I_{ph} + I_s, \quad (1)$$

where I_t , I_e , I_i , I_{ph} and I_s are, respectively the total current, the electron current, the ion current, the photoelectron current and the secondary emission current. When photoelectrons and secondary emission electrons are not considered, I_{ph} and I_s are both assumed to be zero. When the voltage is negative, the probe collects ions and repels electrons from the ambient plasma, so that the total current is counted positive. This region is called the “ion saturation region”. Similarly, for very positive voltages, the probe repels ions and collects electrons and the total current is then counted negative. This is the “electron saturation region”.

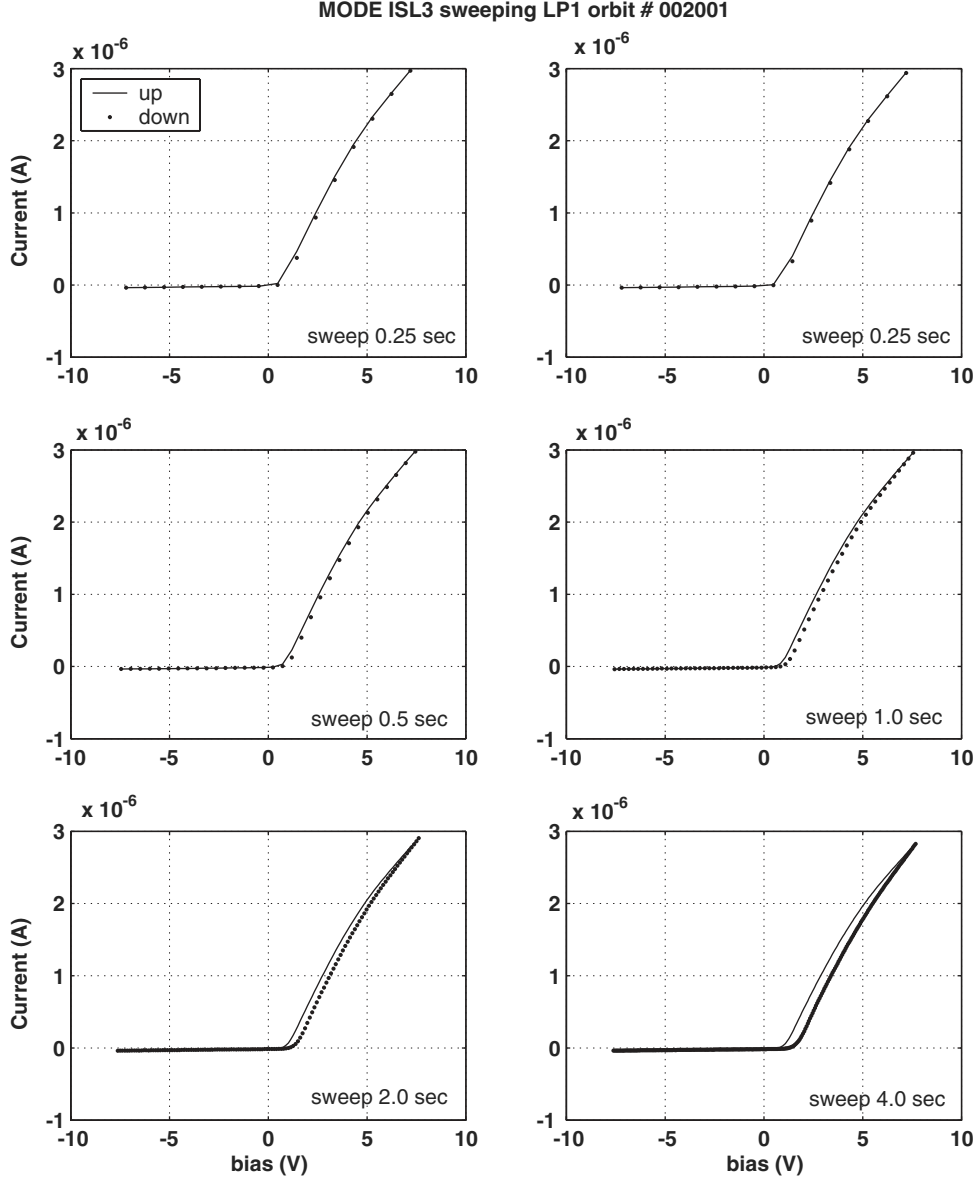

Fig. 5. ISL3 measurements obtained with the cylindrical probe early in the mission. A saw tooth sweep of amplitude ± 7.6 V is applied to the sensor to control the hysteresis, which is a good indicator of the surface cleanliness.

When a charged probe is immersed in a plasma, a sheath of thickness comparable to the Debye length naturally forms around it. There are two different potential values worth defining: the floating potential V_f and the plasma potential V_p (space potential). The floating potential is the potential reached by the probe when the total current to it is zero:

$$I_t(V_f) = I_e(V_f) + I_i(V_f) = 0. \quad (2)$$

As the potential varies across the sheath, the space (plasma) potential is the potential outside the sheath, i.e., the potential of the plasma not locally affected by the probe's presence. In other words, V_p is the plasma at which the probe has to be biased so that the sheath forming around the sensor is minimized.

Between the ion saturation region and the electron saturation region, for intermediate potentials applied to the probe, the electrons are partially repelled. The region is called the transition region or the electron "retardation region", from which we obtain the electron temperature as explained below.

For each of the three specific regions of the $I-V$ characteristic, the formulas giving the contributing currents are the following (e.g. Chen, 1965):

In the ion saturation region, the ion current collected by a cylinder of infinite length at 90° of attack is

$$I_i = N_i e A_i V_i \sqrt{1 + \frac{k_B T_i}{M_i V_i^2} + \frac{2eV}{M_i V_i^2}}, \quad (3)$$

where M_i is the ion mass, N_i and T_i are, respectively the ion density and temperature, A_i is the cross section area of the probe exposed to the ion flow, V_i is the ion flow velocity with respect to the spacecraft, V is the applied voltage relative to the plasma potential, e is the Coulomb charge and k_B is the Boltzman constant. For typical ionospheric plasma conditions, V_i is approximately the spacecraft orbital velocity and is sufficiently large compared to the ion thermal velocity, so that the second term under the square root in Eq. (3) can be neglected. Eq. (3) then simplifies to

$$I_i = N_i e A_i V_i \sqrt{1 + \frac{2eV}{M_i V_i^2}}. \quad (4)$$

In the electron retardation region, the electron current is given by:

$$I_e = N_e e A_e \sqrt{\frac{k_B T_e}{2\pi M_e}} e^{eV/k_B T_e}, \quad (5)$$

where M_e is the electron mass, N_e and T_e are, respectively, the electron density and temperature and A_e is the deployed area of the probe.

In the electron saturation region, for a cylindrical probe, the electron current is given by

$$I_e = N_e e A_e \sqrt{\frac{k_B T_e}{M_e}} \sqrt{1 + \frac{eV}{k_B T_e}}. \quad (6)$$

4.2. Derivation of the main plasma parameters

Here we describe how the electron temperature and density, and the ion density are determined.

The electron temperature is obtained as follows:

When taking the logarithm of Eq. (5), one obtains

$$\text{Log}(I_e) = \frac{eV}{k_B T_e} + \text{Log}\left(N_e e A_e \sqrt{\frac{k_B T_e}{2\pi M_e}}\right). \quad (7)$$

The electron temperature is therefore obtained by the slope of the retardation region, which a straight line on a semi-log scale, that is

$$T_e = \frac{e}{k_B A_{\text{ret}}}, \quad (8)$$

where A_{ret} is the slope of the linear part of the $I-V$ curve in the retardation region in a semilog scale.

In Eq. (6), at the plasma potential, $V = 0$, the second term is equal to zero, the electron density is obtained by the following formula:

$$N_e = \frac{I_e}{e A_e} \sqrt{\frac{M_e}{k_B T_e}}. \quad (9)$$

Ion density: at plasma potential $V = 0$, formula (3) is reduced to:

$$I_i = N_i e A_i V_i, \quad (10)$$

hence the ion density is obtained by the following formula:

$$N_i = \frac{I_i(V = 0)}{e A_i V_i}. \quad (11)$$

One of the difficulties is to determine the ‘‘effective’’ ion collection area A_i as opposed to the geometric cross-section of the probe exposed to the ion flow, as the collector is of finite length. The other difficulty is related to the fact that formula (3), hence (4), applies only when the ion flow velocity is much larger than the ion thermal velocity. This is the case for heavy ion (oxygen) but it does not apply for helium and hydrogen under the ionospheric conditions encountered by DEMETER. A more robust method needs to be developed to retrieve the ion density from the analysis of the ISL $I-V$ curve, which requires a good knowledge of the ion composition.

4.3. Analysis method of the $I-V$ characteristics

There are two main methods for routinely analyzing the $I-V$ characteristics of a Langmuir probe. The first one is based on a graphical method which consists in approximating by analytical curves the three main regions of the $I-V$ characteristics: the ion saturation region, the electron retardation region and the electron saturation region (Hutchinson, 1987). It also allows determining primarily the electron temperature and density, and the plasma potential; it also gives some indication on the ion density but with less accuracy than the electron density. This method works well when the plasma distribution follows a maxwellian distribution and when there are no photoelectrons or secondary particles, and when magnetic field effects are neglected. It is best applicable to the analysis of the night time $I-V$ curves. We shall also apply it to daytime $I-V$ curves, knowing that the ion density may not be accurately determined and the electron temperature may be too high, as when the photoelectron current is not removed, it is seen as an additional ion current in both, the ion saturation region and in the transition region. The second method consists in developing a fitting technique to an analytical expression that represents all current contributions to the probe. This second method will be developed later. In this first paper, we use the first method only and we concentrate on the determination of T_e and N_e .

The analysis method is illustrated graphically in Fig. 6. It consists on the following main steps:

1. Derive an approximation curve for the ion saturation region.
2. Subtract the ion approximation from the total electron current, which gives the electron current.
3. Identify the floating potential.
4. Locate the electron retardation region, measure its slope and retrieve T_e .
5. Identify the plasma potential V_p . This parameter can be obtained from the crossing of the slope of the electron

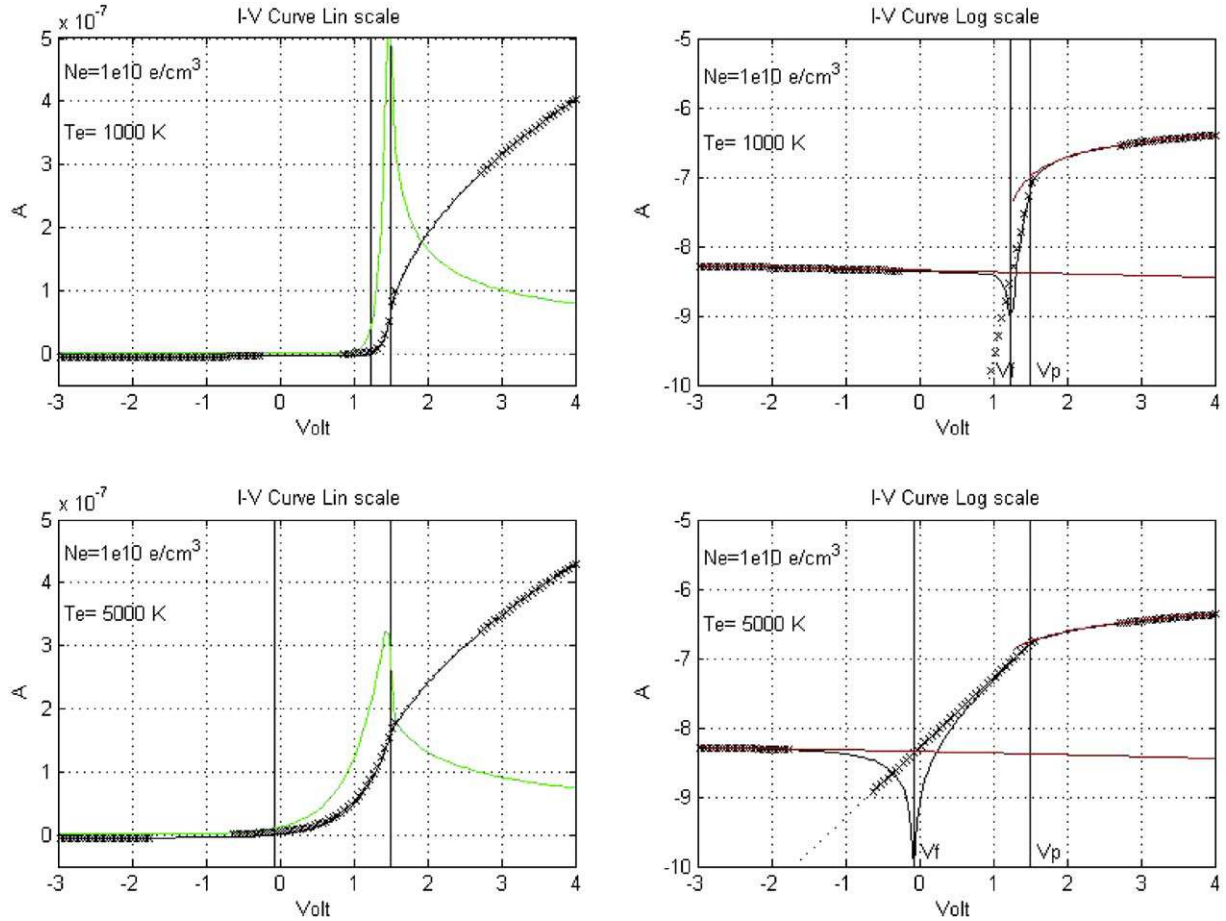

Fig. 6. Illustration of the analysis method of the $I-V$ characteristics (After Hutchinson, 1987).

retardation region and of the approximation curve for the electron saturation region. A polynomial fit of degree 4 works the best. An alternative to determine V_p is to use the first derivative of $I(V)$, since V_p is near the maximum of $I(V)$.

6. Repeat step (3) to refine the plasma potential value if needed; one iteration is often sufficient.
7. Estimate the ion current at V_p from the measured $I-V$ curve and derive the ion density by applying Eq. (4).
8. Estimate the electron current at V_p from the measured $I-V$ curve and derive the electron density by applying Eq. (11).

4.4. The segmented Langmuir probe

The SLP concept is designed to provide sensitivity to the ions arrival angle in the satellite frame of reference, thus providing the capability to disentangle photoemission, secondary emission, magnetic field and plasma drift effects (Berthelier et al., 1982). One of the goals is to use the angular anisotropy of the current collected by each independent collector to get the plasma bulk velocity. The SLP was designed to alleviate some of the difficulties associated with the interpretation of the $I-V$ characteristics of a Langmuir

probe. The DEMETER SLP electrode is divided into seven individual segments, six spherical caps and the guard made up by the rest of the sphere (see Fig. 2b). The six caps are distributed around the sphere such that their surface is oriented in different directions with respect to the plasma flow and to the solar UV radiation, respectively. The six spherical caps of the DEMETER SLP are electrically insulated from each other and from the rest of the sphere (the guard). For the acquisition of the $I-V$ characteristics, all segments of the sphere are biased at the same potential, and the current collected by each segment is measured independently. It is thus possible to study the $I-V$ curve of each sector, and of the rest of the sphere individually. Two main parameters affect the current collected by each sectors. As the ion flow is seen as an ion beam by the probe, only the sectors exposed to the ion flow collect an ion current. The amount of ion current is function of the orientation of the sector with respect to the ion flow in the spacecraft frame of reference. The other important parameter is the solar aspect angle. Only the sectors exposed to the solar UV flux emit photoelectrons. Again the amount of photoelectron current emitted by each sector is function of the solar aspect angle. The SLP concept has been thoroughly tested in a laboratory plasma simulator (Stverak et al., 2003; Stverak, 2004). DEMETER offered the first opportunity to perform a flight

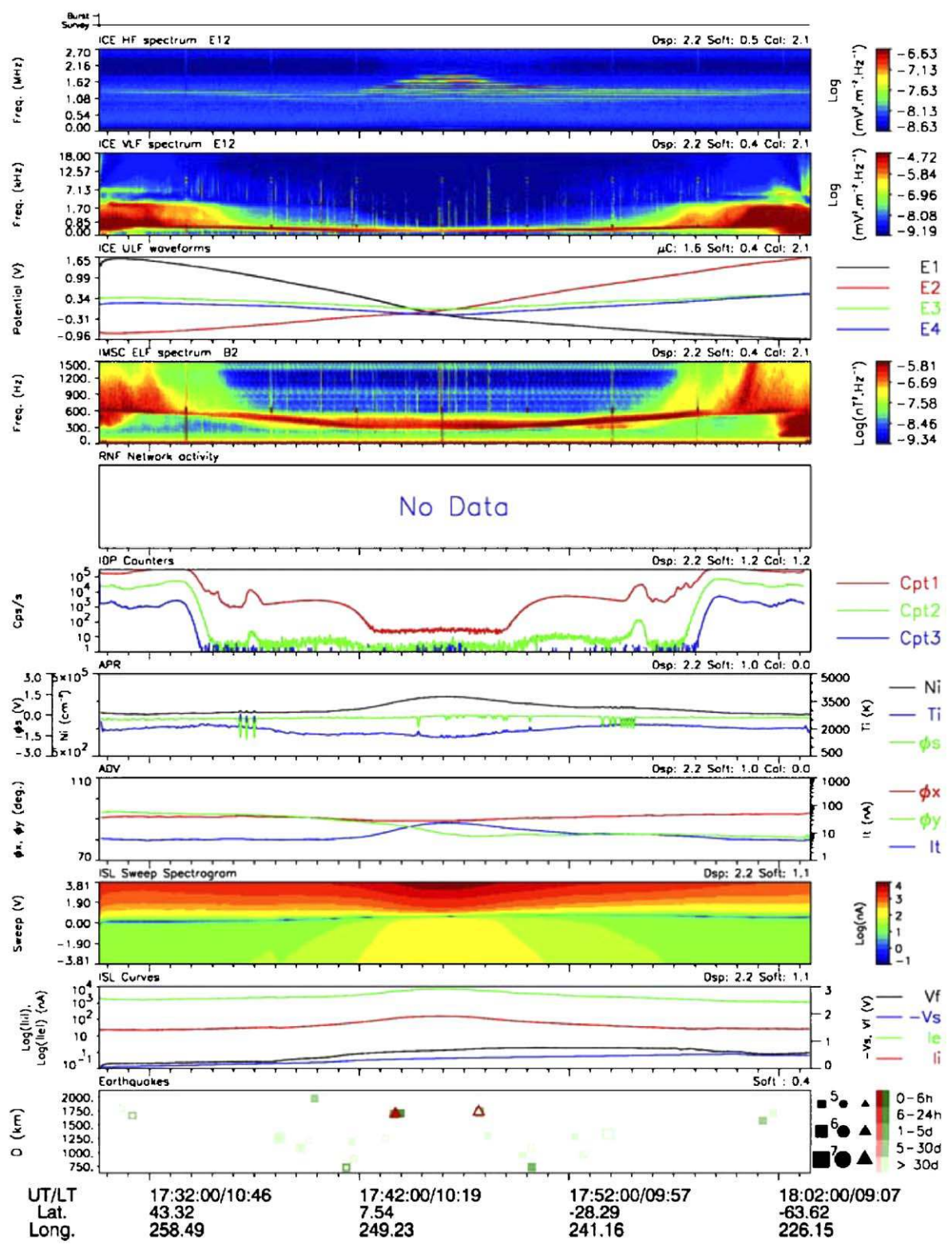

Fig. 7. DEMETER quicklook plot. The ISL panels are panels 9 and 10 from the top. (see text for explanation).

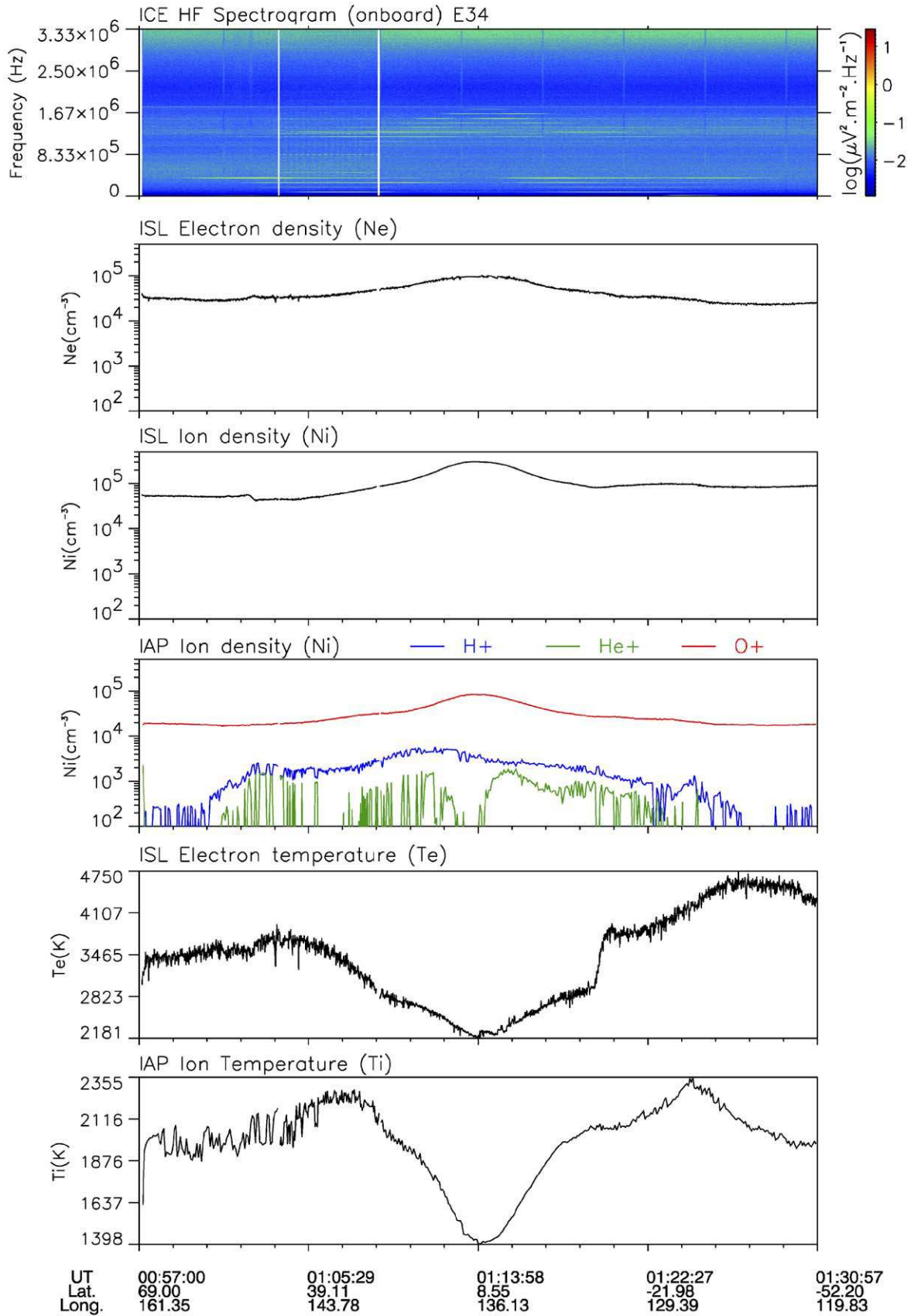

Fig. 8. Combined ISL and IAP data that can be produced using the N2 level software on the DEMETER data server.

test of this novel Langmuir probe sensor. The guard of the SLP is also used as a spacecraft potential sensor. A proper model taking into account the attitude of the spacecraft with respect to the plasma flow and the solar aspect angle needs to be developed for the correct interpretation of the $I-V$ curves obtained by the SLP. The capabilities of the SLP to diagnose bulk plasma parameters and the effects of the bulk plasma velocity on the determination of those plasma parameters have been investigated in a separate study (Séran et al., 2005). They have developed a particle in cell (PIC) numerical model of the current collected by a sphere which has been applied to the SLP. The comparison of the numerical results with in-flight DEMETER measurements shows a very promising agreement. The SLP is only used for selected periods during the nominal DEMETER mission, and is not further addressed in this paper.

4.5. Data representations

When connecting to the DEMETER Mission Science Data Centre (Lagoutte et al., 2005), the user has access to

two different kinds of DEMETER science plots: quicklook plots and level 2 plots of level 1 data.

We present one example of a quicklook plot in Fig. 7. The ninth and tenth panels from the top represent the ISL data. The ninth panel is a spectrogram-like representation. Each $I-V$ characteristic is represented as a vertical line colour-coded. The colour code corresponds to the intensity of the absolute value of the current in a logarithmic scale. This allows to better illustrate the large dynamic of the current variation. The tenth panel represents the variations of the electron (resp. ion) currents collected at max (resp. minimum) probe bias, and the variation of the probe floating potential and of the spacecraft potential measured by LP2 (note that this measurement has not yet been fully validated at the time of this writing).

Fig. 8 gives an example of combining level 1 ISL data and level 1 data from the thermal plasma instrument IAP (Berthelier et al., this issue). The IAP instrument measures the densities and temperature of the main ion components of the plasma. ISL-derived electron density and IAP-derived ion density are comparable as expected, within the measurements accuracy. The ISL-derived ion density is

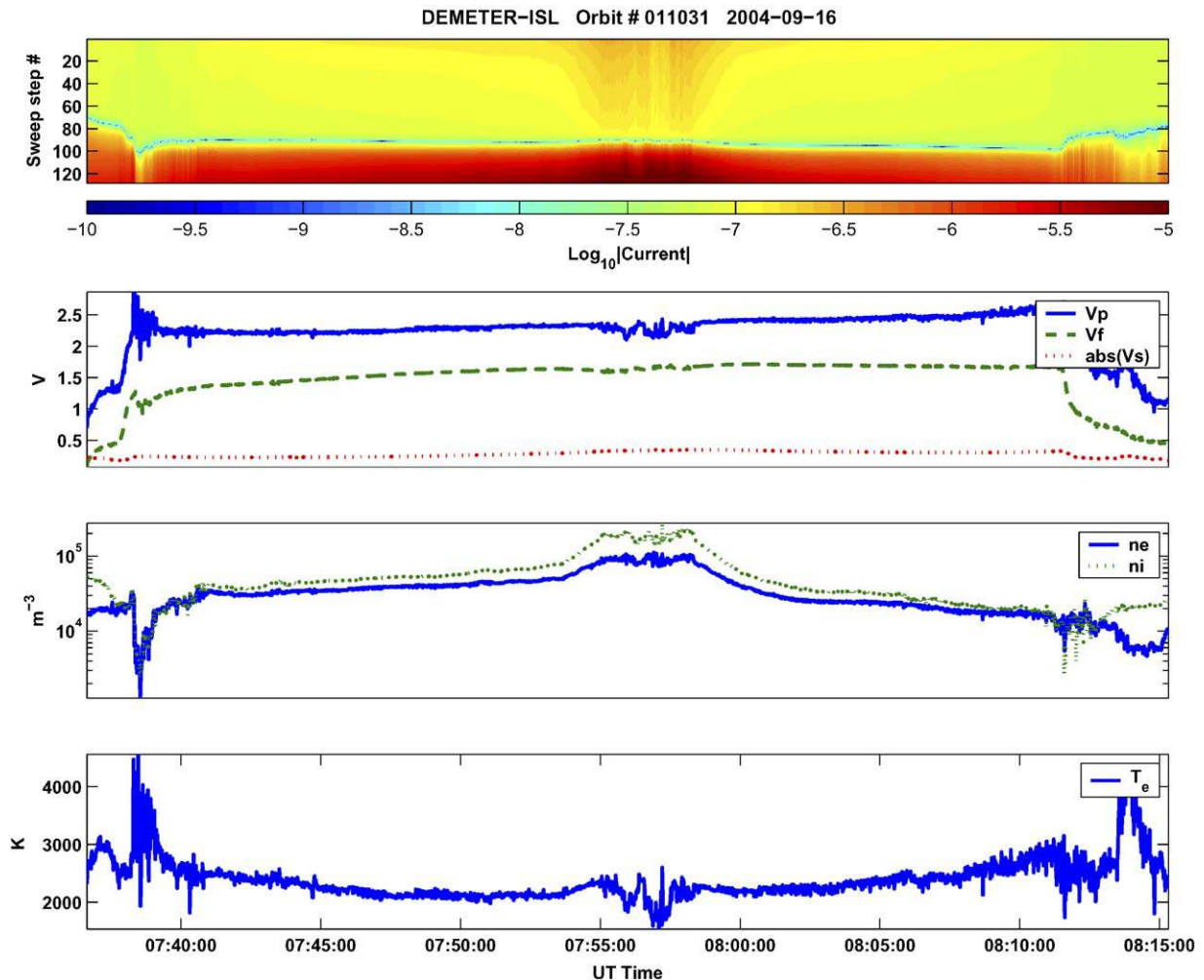

Fig. 9. ISL parameters recorded by the ISL cylindrical probe along a DEMETER half-orbit.

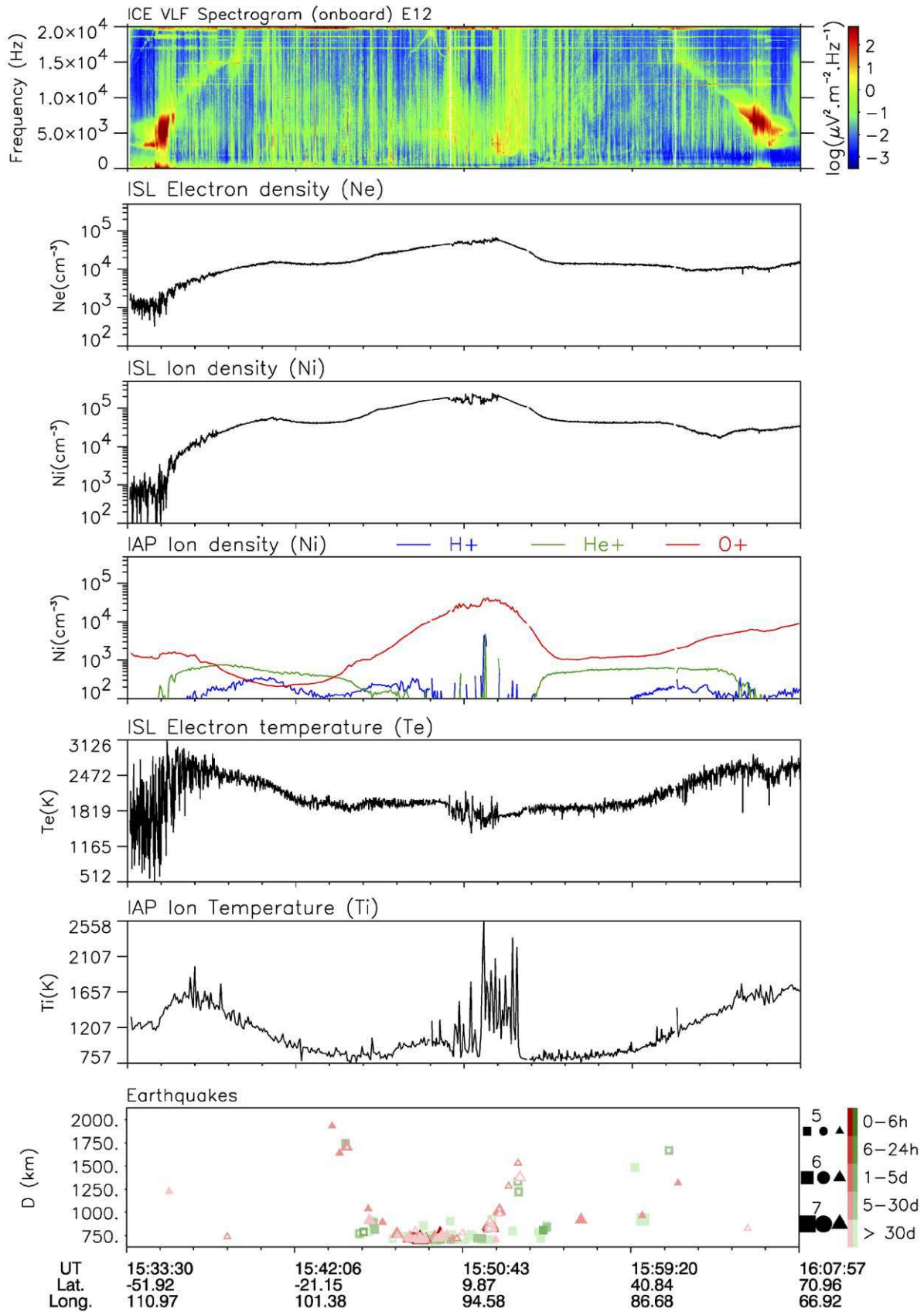

Fig. 10. ISL observations during the M8.6 Sumatra earthquake on 28-03-2005 at around 15:50. Spread-F activity is most likely on-going at the time DEMETER is flying over the earthquake region.

subject to caution as it is obtained from a standard $I-V$ curve analysis which does not take properly into account the ion composition and the photoelectron effects. For these reasons, at this stage, the ISL-derived ion density should not be used for scientific investigations. However, ion density variation may be used to identify ionospheric effects.

5. Preliminary ISL science results

Several specific features, such as equatorial F-region irregularities or plasma variations in the auroral zone, can be observed in Fig. 9. This figure represents a global view of the plasma environment variation along a DEMETER half-orbit. The observations are described briefly for illustrating the measurement capabilities of ISL.

5.1. Equatorial F-region irregularities

Irregularities are often seen around the magnetic equator in the evening sector of the orbit. Those irregularities are most likely associated with spread-F irregularities which have been studied since many decades. These natural disturbances should be well identified not to be confused with seismic-related perturbations. A spread-F event is most likely observed at the time of the M8.6 Sumatra

earthquake event of 28 March 2005, which was overflowed by DEMETER a few minutes before it occurred (Fig. 10). Furthermore, it is also interesting to further characterize these ionospheric disturbances as they are known to affect satellite telecommunications. The cluster data downlink at S-band using the low latitude Mas Palomas receiving station is regularly suffering some signal degradation which has been correlated with the occurrence of equatorial spread-F irregularities (H. Laakso, private communication, 2004). Radar and satellite studies suggest that large scale F-region plasma depletions and plumes result from the upward convection and amplification of bottom side horizontal undulations probably generated by atmospheric gravity waves (Laakso et al., 1995, and reference therein).

5.2. Plasma variation in the auroral zones

Mostly during night times, significant plasma variability is observed in the auroral zone in the evening segment of the orbit. Plasma depletions are also observed, where the plasma density may be a factor of 5–10 lower than in the mid-latitude and equatorial regions. When traversing the auroral oval, localized plasma density depletions (holes), accompanied by significant plasma heating (by a factor 2–4) are also often observed. It should be noted however that, under those auroral plasma conditions, the plasma

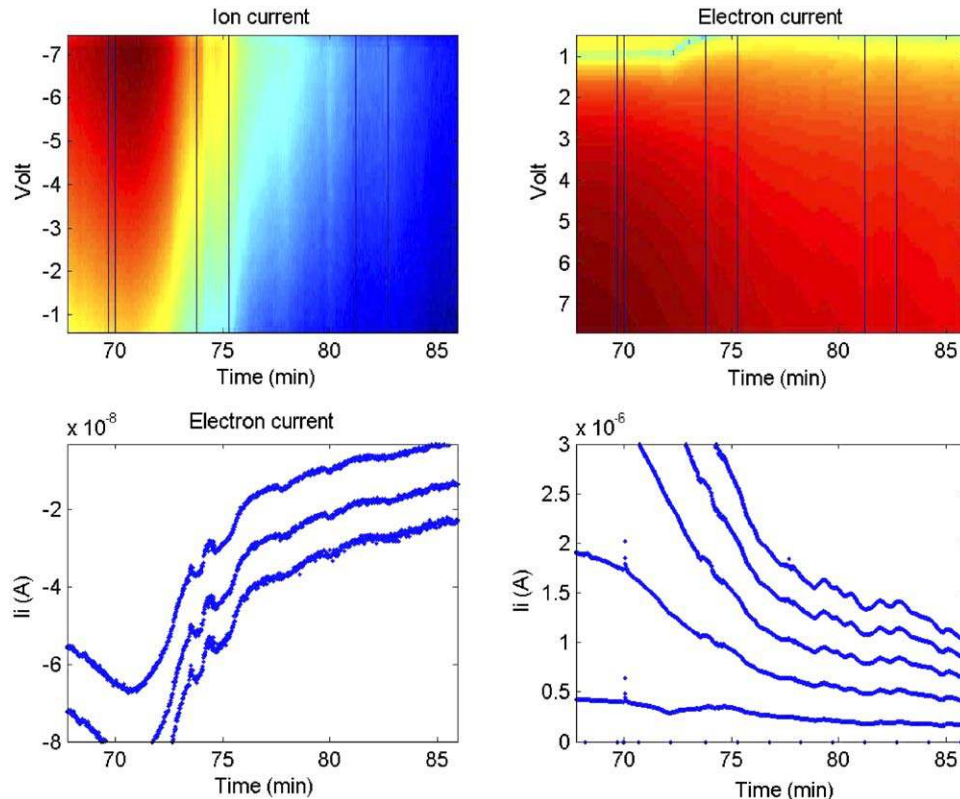

Fig. 11. Wave-like pattern variation observed in the ISL data during an event first identified by IAP. A low period time variation is seen in both the ion and the electron current. The line plots correspond to current variation at a few selected fixed probe bias (which is extracted from the time series of $I-V$ curves). The ion curves have been displaced vertically to enhance legibility.

parameters, the electron temperature in particular, derived by applying the standard processing of the Langmuir probe I - V curve, may lead to inaccurate plasma parameters although qualitatively the effects is clearly identified (Fig. 9).

5.3. Low amplitude wave pattern detection

A low-amplitude wave pattern was originally detected by the IAP instrument on orbit 1160-0 (Berthelier, private communication, 2005). This event has been investigated with the ISL data. It is presented in Fig. 11. A small amplitude wave pattern is also seen in the ISL data, when displayed in an adequate way. The wave pattern is best seen in the colour spectrograms, and it seems more visible in the electron saturation region than in the ion saturation region. This pattern may be the ionospheric signature of a tropospheric perturbation as discussed by Bauer (1957).

6. Conclusions

The DEMETER Langmuir probe instrument ISL has been described in detail and the main instrument operation modes explained. The ISL instrument operates flawlessly since launch. The main plasma parameters that can be reliably extracted from the ISL current-voltage response are the electron temperature and density and the plasma potential. Variations of these three parameters are obtained with a time resolution of 1 s. Work is in progress to derive the ion density with ISL. The concept of the segmented Langmuir probe, flown for the first time on DEMETER, has been described, and initial results briefly discussed. Examples of geophysical phenomena observed with ISL have been shown to illustrate the instrument capability. It is anticipated that a complete data set will be acquired over the lifetime of the mission that will allow addressing the main DEMETER science objectives through statistical studies. ISL may also provide a valuable data set for spaceweather-related ionospheric studies.

Acknowledgments

The IAP data used in Fig. 8 were provided by J.-J. Berthelier.

References

Afonin, V.V., Molchanov, O.A., Kodama, T., Hayakawa, M., Akentieva, O.A., 1999. Statistical study of ionospheric plasma response to seismic activity: search for reliable result from satellite observations. In: Hayakawa, M. (Ed.), *Atmospheric and Ionospheric Electromagnetic Phenomena Associated with Earthquakes*, pp. 597–617.

Bauer, S.J., 1957. A possible troposphere-ionosphere relationship. *J. Geophys. Res.* 62, 425–430.

Bauer, S.J., 1958a. An apparent ionosphere response to the passage of hurricanes. *J. Geophys. Res.* 63, 265–269.

Bauer, S.J., 1958b. Correlations between tropospheric and ionospheric parameters. *Geofis. Para. Appl.* 40, 235–240.

Bering, E.A., Kelley, M.C., Mozer, F.S., Fahlson, U.V., 1973. Theory and operation of the split Langmuir Probe. *Planet. Space Sci.* 21, 1983–1986.

Berthelier, J.-J., Covinhes, J., Godefroy, M., Gogly, G., Guerin, C., Roux, D., Thevenet, P., Gladyshev, V.A., 1982. The thermal ion mass spectrometer on board AUREOL-3—The DYCTION experiment. *Ann. Geophys.* 38, 591–614.

Berthelier et al., ICE Experiment. This issue.

Berthelier et al., IAP Experiment. This issue.

Brace, L.H., 1996. Langmuir probe measurements in the ionosphere. In: Borovsky, J., Pfaff, R., Young, D. (Eds.), *Measurement Techniques in Space Plasmas*. AGU.

Brace, L.H., Carignan, G.R., Findlay, J.A., 1971. Evaluation of ionospheric electron temperature measurements by cylindrical probes. *Space Res.* 11, 1079–1105.

Brace, L.H., Theis, R.F., Dalgarno, A., 1973. The cylindrical electrostatic probes for Atmospheric Explorer-C, D, and E. *Radio Sci.* 8, 341–348.

Chapkunov, S. K., Ivanova, T.N., Petrunova, M. K., Serafimov, K.B., 1976. Measurement of electron and ion density and temperature on the INTERCOSMOS 12 satellite. *Space research XVI; Proceedings of the Open Meetings of Working Groups on Physical Sciences*, May 29–June 7 1975, pp. 423–425.

Chen, F.F., 1965. Electric probes. In: Huddleston, R.H., Leonard, S.L. (Eds.), *Plasma Diagnostics Techniques*. Academic press, New York, pp. 113–199.

Cussac et al., The DEMETER Microsatellite: System Description and Early in Flight Results, PSS. This issue.

Gurnett, et al., 2004. The Cassini radio and plasma wave investigation. *Space Sci. Rev.* 114, 395–463.

Hutchinson, I.H., 1987. *Principles of Plasma Diagnostics*. Cambridge University Press, Cambridge, pp. 55–66.

Laakso, H., Aggson, T.L., Herrero, F.A., Pfaff, R.F., Hanson, W.B., 1995. Vertical neutral wind in the equatorial F-region deduced from electric field and ion density measurements. *J. Atmos. Terr. Phys.* 57, 645–651.

Laframboise, J., 1966. Rarefied gas dynamics. In: de Leeuw, J.H. (Ed.), *Proceedings of the fourth International Symposium, Toronto*, vol. 2. Academic, New York, p. 22.

Lagoutte et al., 2005. Mission Science Data Center, PSS. This issue.

Langmuir, L., Moth-Smith, H., 1924. Studies of electric discharges in gases at low pressures. *Gen. Elect. Rev.* 27, 616–623 762–771, 810–820.

Ondoh, T., 1999. Seismo-ionospheric effects. In: Hayakawa, M. (Ed.), *Atmospheric and Ionospheric Electromagnetic Phenomena Associated with Earthquakes*, pp. 789–803.

Parrot, M., et al., 2005. The magnetic field experiment and its data processing onboard DEMETER: scientific objectives, description and first results. *Planet. Space Sci.*, this issue, doi:10.1016/j.pss.2005.10.015.

Séran, E., Berthelier, J.-J., Saouri, F.Z., Lebreton, J.-P., 2005. The spherical segmented Langmuir probe in a flowing thermal plasma: numerical model of the current collection. *Ann. Geophys.* 23, 1723–1733.

Stverak, S., 2004. Software for the processing of the data from Langmuir probe measurements in plasmas. Diploma Thesis.

Stverak, S., Paral, J., Hostinsky, Z., Travnicek, P., 2003. Testing segmented Langmuir probe in a plasma chamber (refereed). WDS '03 Papers, Part II.

Wahlström, M.K., Johansson, E., Veszelei, E., Bennich, P., Olsson, M., Hogmark, S., 1992. Improved Langmuir probe surface coatings for the Cassini satellite. *Thin Solid Films* 220, 315–320.