



HAL
open science

POLYMORPH AND POLYTYPE IDENTIFICATION FROM INDIVIDUAL MICA PARTICLES USING SELECTED AREA ELECTRON DIFFRACTION

Anne-Claire Gaillot, Victor A Drits, Bruno Lanson

► **To cite this version:**

Anne-Claire Gaillot, Victor A Drits, Bruno Lanson. POLYMORPH AND POLYTYPE IDENTIFICATION FROM INDIVIDUAL MICA PARTICLES USING SELECTED AREA ELECTRON DIFFRACTION. *Clays and Clay Minerals*, 2020, 68 (4), pp.334-346. 10.1007/s42860-020-00075-9 . insu-02984565

HAL Id: insu-02984565

<https://insu.hal.science/insu-02984565>

Submitted on 24 Nov 2020

HAL is a multi-disciplinary open access archive for the deposit and dissemination of scientific research documents, whether they are published or not. The documents may come from teaching and research institutions in France or abroad, or from public or private research centers.

L'archive ouverte pluridisciplinaire **HAL**, est destinée au dépôt et à la diffusion de documents scientifiques de niveau recherche, publiés ou non, émanant des établissements d'enseignement et de recherche français ou étrangers, des laboratoires publics ou privés.

Clays and Clay Minerals

Polymorph and polytype identification from individual mica particles using selected area electron diffraction

--Manuscript Draft--

Manuscript Number:	CLAY-D-19-00194R2
Full Title:	Polymorph and polytype identification from individual mica particles using selected area electron diffraction
Article Type:	Original Paper
Funding Information:	
Abstract:	<p>Diocahedral micas are composed of two tetrahedral sheets and one octahedral sheet to form TOT or 2:1 layers. These minerals are widespread and occur with structures differing by (i) the layer stacking mode (polytypes), (ii) the location of vacancies among non-equivalent octahedral sites (polymorphs), and (iii) the charge-compensating interlayer cation and isomorphic substitutions. The potential of parallel-illumination electron diffraction (ED) is assessed here to determine the polytype/polymorph of individual crystals of finely divided dioctahedral micas and to image their morphology. ED patterns are calculated along several zone axes close to the c^*- and c-axes using the kinematical approximation for trans - and cis -vacant varieties of the four common mica polytypes (1 M , 2 M 1 , 2 M 2 , and 3 T). When properly oriented, all ED patterns have similar geometry, but differ by their intensity distribution over hk reflections of the zero-order Laue zone. Differences are enhanced for ED patterns calculated along the [001] zone-axis. Identification criteria are proposed for polytype/polymorph identification, based on the qualitative distribution of bright and weak reflections. A database of ED patterns calculated along other zone-axes is provided in case the optimum [001] orientation cannot be found. Different polytype/polymorphs may exhibit similar ED patterns depending on the zone axis considered.</p>
Corresponding Author:	Anne-Claire Gaillot Institut des materiaux Jean Rouxel FRANCE
Corresponding Author Secondary Information:	
Corresponding Author's Institution:	Institut des materiaux Jean Rouxel
Corresponding Author's Secondary Institution:	
First Author:	Anne-Claire Gaillot
First Author Secondary Information:	
Order of Authors:	Anne-Claire Gaillot Victor A. Drits Bruno Lanson
Order of Authors Secondary Information:	
Author Comments:	<p>Dear Editor,</p> <p>Acting as the corresponding author, I have uploaded the revised version of the manuscript after considering the corrections suggested by the Associate Editor, and moving both figures of the supplementary materials in the main body of the manuscript as suggested.</p> <p>The figures were now provided in the EPS format. Hoping that this version of the manuscript is now suitable for publication, I thank you in advance for your editorialship.</p> <p>Sincerely yours, Anne-Claire GAILLOT</p>

Response to Reviewers:	All corrections suggested by the Associate Editor were implemented in the manuscript, and Figures S1 and S2 initially presented as supplementary materials, were inserted in the main body of the manuscript (now Figures 1 and 3), as suggested by the Associate Editor. Other figures were then renumbered.
Suggested Reviewers:	Buseck Peter pbuseck@asu.edu specialist of TEM and clay structure
	Kenneth Livi klivi@jhu.edu specialist of TEM and clay structure

[Click here to view linked References](#)

1 **Polymorph and polytype identification from individual mica particles using selected area**
2 **electron diffraction**

3 Anne-Claire Gaillot^{1,*}, Victor A. Drits², Bruno Lanson³

4 ¹ Université de Nantes, CNRS, Institut des Matériaux Jean Rouxel, IMN, F-44000 Nantes, France

5 ² Geological Institute, Russian Academy of Sciences, 7 Pyzhevsky street, 109017 Moscow, Russia

6 ³ Univ. Grenoble Alpes, CNRS, Univ. Savoie Mont Blanc, IRD, IFSTTAR, ISTerre, F-38000

7 Grenoble, France

8 * Author to whom correspondence should be addressed.

9 e-mail: Anne-Claire.Gaillot@cnrs-imn.fr

10 **Abstract.** Dioctahedral micas are composed of two tetrahedral sheets and one octahedral sheet to
11 form TOT or 2:1 layers. These minerals are widespread and occur with structures differing by (i)
12 the layer stacking mode (polytypes), (ii) the location of vacancies among non-equivalent octahedral
13 sites (polymorphs), and (iii) the charge-compensating interlayer cation and isomorphic
14 substitutions. The potential of parallel-illumination electron diffraction (ED) is assessed here to
15 determine the polytype/polymorph of individual crystals of finely divided dioctahedral micas and
16 to image their morphology. ED patterns are calculated along several zone axes close to the c^* - and
17 c -axes using the kinematical approximation for *trans*- and *cis*-vacant varieties of the four common
18 mica polytypes ($1M$, $2M_1$, $2M_2$, and $3T$). When properly oriented, all ED patterns have similar
19 geometry, but differ by their intensity distribution over hk reflections of the zero-order Laue zone.
20 Differences are enhanced for ED patterns calculated along the [001] zone-axis. Identification
21 criteria are proposed for polytype/polymorph identification, based on the qualitative distribution of
22 bright and weak reflections. A database of ED patterns calculated along other zone-axes is provided
23 in case the optimum [001] orientation cannot be found. Different polytype/polymorphs may exhibit
24 similar ED patterns depending on the zone axis considered.

25 **Keywords.** Cis-vacant, Dioctahedral mica, Electron diffraction, Illite, Muscovite, Polymorph,
26 Polytype, Trans-vacant, Zone-axis orientation.

28 K-bearing, aluminous, dioctahedral micas such as illite, muscovite, or phengite, are most
29 abundant in nature and occur, for example, in diagenetically altered sediments, soils, low-grade
30 metamorphic rocks, and igneous and hydrothermal systems (Bailey 1984; Mottana et al. 2004 and
31 references therein). Ideally, their 2:1 layers are composed of a sheet of edge-sharing Al^{3+} octahedra
32 set between two sheets of Si^{4+} tetrahedra. In dioctahedral micas, one out of three octahedral sites
33 is vacant. Isomorphic substitutions can occur both in octahedral and tetrahedral sheets to produce
34 a layer charge deficit which is compensated by interlayer K^+ cations. Interactions between adjacent
35 layers are relatively weak and produce energetic similarity of polytypes with different layer
36 stacking. Two or more polytypes can coexist even within a crystal. Whereas polytypes differ
37 mainly by their stacking sequences, polymorphs result from different locations of the octahedral
38 vacancy within the 2:1 layer. The average polytypic/polymorphic components of a sample can be
39 determined using X-ray diffraction or thermo-gravimetric analysis (Drits et al. 1984, 1993, 1998;
40 Bailey 1988; Emmerich et al., 1999; Drits & Sakharov 2004; Zviagina et al. 2007). Determining
41 the structure of individual particles requires a local probe and electron microscopy techniques are
42 ideal candidates. Periodicity normal to 2:1 layers and occurrence and nature of stacking faults can
43 be determined from electron diffraction (ED) patterns or high-resolution images collected with the
44 incident electron beam parallel to the layers (Kogure & Banfield 1998; Kogure & Nespolo 1999;
45 Kameda et al. 2007; Kogure & Kameda 2008; Kogure et al. 2008). As a possible alternative to the
46 latter approach, Gaillot et al. (2011) showed that ED patterns collected along the [001] zone axis
47 can also be used to determine the periodicity along the stacking direction from $hk0$ intensities and
48 to obtain structural information such as location of the octahedral vacancy. This method is more
49 limited than when crystals are oriented normal to [001]. A minimal sample preparation (a drop of

50 a diluted suspension dried on the support) produces many well-oriented crystals quickly and both
51 morphological and structural information is then available.

52 Morphology of illite, muscovite, or phengite and possibly their (qualitative) chemistry,
53 were shown to be correlated to crystal structure (Lanson et al. 1996, 2002; Patrier et al. 2003;
54 Laverret et al. 2006). This link could not be unambiguously established using global methods such
55 as X-ray diffraction (XRD), thermogravimetric analysis (TGA), or infrared (IR) spectroscopy,
56 however, and the method proposed here thus provides a unique opportunity to (in)validate the
57 established qualitative relationship from the characterization of individual finely divided crystals.
58 If valid, this relationship may be important in determining structure characteristics of mica crystals
59 coating quartz grains in relation to their impact on oil reservoir quality, especially on permeability
60 (Morris & Shepperd 1982; Pallatt et al. 1984; Kantorowicz 1990; Pevear 1999; Wilson et al. 2014).
61 Crystal morphologies ranging from one-dimensional (1D) "hairy" illite to more isometric pseudo-
62 hexagonal 2D plates were reported for illite as a function of maximum burial depth and size fraction
63 in sandstone reservoirs (Lanson et al. 2002 and references therein; Wilson et al. 2014). A structural
64 control on crystal morphology could determine the origin of the morphological variability. The
65 possibility of determining the morphology, dimensions, and crystal structure of individual plates
66 may have implications for crystal growth mechanisms of the different polytype/polymorphs.

67 Convergent-beam electron diffraction (CBED) patterns can also be used to determine
68 periodicity along the c^* -axis from both $hk0$ and $hk1$ reflections of the zero- and first-order Laue
69 zones (ZOLZ and FOLZ) using minimal sample preparation and crystal orientation (Beermann &
70 Brockamp 2005). CBED application to clay minerals has been limited. First, diffraction intensity
71 is very weak beyond $hk0$ spots and $hk1$ spots from the FOLZ because clay-size micas occur as thin
72 crystals composed mainly of weakly scattering atoms (Si, Al, Mg, O). Second, stacking defects are
73 common even in well-ordered dioctahedral aluminous micas, and the defects induce elongated

74 reciprocal rods along the c^* -axis. Finally, CBED patterns allows collection of diffraction patterns
75 from a limited crystal surface area (a few nm^2), thus limiting variation in crystal orientation.
76 However, the high electron dose required for CBED pattern collection, with the electron beam fully
77 condensed on mica crystals, often results in sample damage, ranging from amorphization to crystal
78 “drilling”. Beam damage also occurs when *cis*-vacant (see below) layers of illite and smectite and
79 *trans*-vacant layers of nontronite are imaged at high resolution. In these cases, layers dehydroxylate
80 owing to the high electron dose which results in cation migration from one octahedral site to
81 another (Kogure & Drits 2010). In contrast, conventional parallel-illumination ED (selected-area
82 electron diffraction, SAED) requires very low electron dose compared to CBED, while producing
83 averaged intensities over a larger ZOLZ area (Vincent & Midgley 1994). SAED allows retrieving
84 layer stacking information in the direction parallel to the electron beam (Gaillot et al. 2011).
85 Information on the vacancy location (polymorphism – *cis*- or *trans*-vacant configuration) can also
86 be obtained for the *1M* polytype.

87 Charge-coupled devices (CCD) cameras on microscopes allow recording quantitative
88 intensities for ED spots. Structure identification remains challenging, however, owing to the
89 camera dynamics needed to record ED patterns equal to the high quality achievable with films or
90 recording plates. A small beam stop commonly used to avoid saturating the CCD camera is
91 essential also to avoid masking part of the ED pattern. A small beam stop allows the optimization
92 of orientation during data collection and the analysis of the diffraction intensity distribution.
93 However, intrinsic properties of mica crystals further impair quantitative analysis. The coexistence
94 and interstratification of polytypic and polymorphic varieties within a crystal was addressed by
95 Gaillot et al. (2011), together with the impact of variable crystal thickness on mica ED patterns. In
96 addition, mica plates may be bent, or have growth steps, or variable chemical compositions, which
97 result in inhomogeneous local diffraction conditions. The influence of these additional parameters

98 on the intensity diffracted by dioctahedral 2:1 micas is investigated in the present study.
 99 Identification criteria of mica polytypes are proposed using qualitative intensity distributions
 100 within [001] ED patterns, together with a database of ED patterns for a selected set of crystal
 101 orientations.

102 STRUCTURE MODELS AND METHODS

103 *Structure models*

104 The structural formula for K-bearing aluminous dioctahedral micas (Bailey 1984) is:



106 where octahedral R^{2+} cations are Mg^{2+} and Fe^{2+} . To simplify structure models, the
 107 interlayer site was assumed to host 1.0 K^+ cation per $\text{O}_{10}(\text{OH})_2$. Al^{3+} -for- Si^{4+} , and Mg^{2+} -for- Al^{3+}
 108 substitutions and H were ignored because they have negligible effects on the structure factors of
 109 hkl reflections, leading to the following simplified composition:

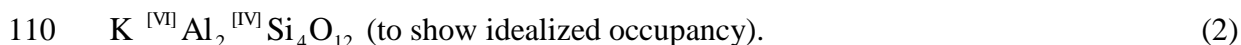

111 A complete $\text{Fe}^{2+,3+}$ -for- Al^{3+} substitution in the octahedra, as in celadonite [ideally
 112 $\text{K}^{[\text{VI}]} (\text{Fe}^{3+} \text{Fe}^{2+})^{[\text{IV}]} \text{Si}_4 \text{O}_{10} (\text{OH})_2$], was investigated to show the effect of the greater scattering.
 113 Unit-cell parameters and atomic coordinates were kept constant despite the ionic radii difference
 114 between Fe and Al. Similarly, Na^+ -for- K^+ replacement, as in paragonite [ideally
 115 $\text{Na}^{[\text{VI}]} (\text{Al}_2)^{[\text{IV}]} (\text{Si}_3 \text{Al}) \text{O}_{10} (\text{OH})_2$], on ED intensity distribution was assessed.

116 *Trans- and cis-vacant 1M polymorphs.* In ideal one-layer monoclinic (1M) mica
 117 polytypes, all 2:1 layers have the same azimuthal orientation and the layer displacement T_x is about
 118 $-a/3$ along the **a**-axis, **a** being defined from the orthogonal C-centered cell described by Bailey

119 (1988) and given in Table 1 ($b = a\sqrt{3}$, $\gamma = 90^\circ$). Where the octahedral M1 site is empty and M2 and
120 M2' are filled, the 2:1 layer is *trans*-vacant (tv) with a $C2/m$ symmetry. When the M2 (or M2') site
121 is vacant and M1 and M2' (or M2) sites are occupied, the 2:1 layer is *cis*-vacant (cv) with a $C2$
122 symmetry (Bailey 1984). The two polymorphs possess identical layer plane unit-cell dimensions
123 (a , b , γ) and layer-to-layer distance ($T_z = c.\sin\beta$) for identical compositions (Drits et al. 1984). They
124 differ however by their layer displacement along the **a**-axis with $T_x = c.\cos\beta$ values of $-0.383a$
125 and $-0.308a$, for tv- and cv- $1M$, respectively (Table 1; Drits et al. 1984). Coordinates of the
126 octahedral sites also differ slightly between the two polymorphs. Because tv and cv layers can
127 coexist within $1M$ mica crystals (McCarty & Reynolds 1995; Drits & McCarty 1996; Ylagan et al.
128 2000), random interstratifications are averaged by diffraction to produce a simplified cell (M-cell).
129 In the average M-cell, the octahedral sheet is not distorted, octahedral sites are partially occupied,
130 and the interlayer displacement T_x is $-0.333a$ (Drits et al. 1984). Crystals with interstratifications
131 having contrasting proportions of tv and cv layers may be described by varying the occupancy of
132 M1, M2, and M2' sites (w_1 , w_2 , and w_2' , respectively). For example, $w_1 = 0$ and $w_2 = w_2' = 1$ [M-
133 cell with (0:1:1)] correspond to tv- $1M$ micas, whereas $w_1 = w_2 = 0.5$ and $w_2' = 1$ [M-cell with
134 (0.5:0.5:1)] correspond to the interstratification of tv and cv layers in a 1:1 ratio.

135 *2M₁, 2M₂, and 3T polytypes.* In two-layer monoclinic polytypes, successive layers are
136 alternately rotated by $\pm 120^\circ$ or $\pm 60^\circ$ ($2M_1$ and $2M_2$ polytypes, respectively). Each **c**-axis forms an
137 oblique angle β with [100] and their projection on the **a**-axis corresponds to the overall layer
138 displacement of $\sim -a/3$ (for 2 layers). In contrast to all other mica polytypes, the **a** vector of the $2M_2$
139 polytype corresponds to the long dimension of the orthogonal cell in the **ab**-plane (with $a \sim b\sqrt{3}$),
140 thus producing major differences for the orientation of ED patterns and subsequent analysis (see
141 below). In the three-layer trigonal $3T$ polytype, successive layers are rotated by 120° with respect
142 to the preceding layer and the overall layer displacement is null. Structure models of $2M_1$ and $3T$

143 polytypes were refined from muscovite and phengite X-ray and neutron diffraction data (#86622
144 and #75952 of the ICSD database – Amisano-Canesi et al. 1994; Liang et al. 1998), whereas the
145 $2M_2$ model corresponds to the refinement of oblique texture ED data from a natural mica
146 (Zhoukhlistov et al. 1974). Layer chemistry was simplified for each model to match Eq. 2. Cv
147 structures were modeled from those of tv polymorphs by changing occupancy of octahedral sites,
148 while unit-cell parameters and atomic positions were kept unchanged. Unit-cell parameters are
149 listed in Table 1 for all polytypes considered.

150 *Theoretical ED calculations*

151 Dynamical effects are minor for most fined-grained mica crystals of thickness 10-25 nm
152 if the structure consists essentially of light elements (Gaillot et al. 2011). In addition, natural micas
153 occur as mosaic crystals, thus reducing the likelihood of multiple scattering and further minimizing
154 dynamical effects on ED patterns (Drits 1987; Gaillot et al. 2011). To assess this assumption,
155 SAED patterns were collected using 1° and 2° precession angles of the incident electron beam to
156 minimize dynamical diffraction effects (Vincent & Midgley 1994), and compared with ED patterns
157 obtained with no beam precession (Fig. 1). The similarity of ED patterns confirms the quasi absence
158 of dynamical diffraction effects. Consequently, qualitative interpretation of the ED patterns used
159 the kinematical approximation (single scattering event) only with the JEMS simulation software
160 package (Stadelmann, 1999). See Gaillot et al. (2011) for simulation parameters. Intensities are
161 proportional to the square of the structure factor (F^2), modulated by the excitation error s . A s value
162 of 0.2 nm^{-1} allows matching the extension of the experimental ZOLZ region while excluding
163 contribution from the FOLZ. Calculated intensities are displayed with a spot radius proportional to
164 F to mimic intensity differences. Crystal thickness was not considered.

165 *Experimental ED patterns*

166 Origin and chemical compositions of the two illite specimens investigated are described
167 by Gaillot et al. (2011). Briefly, the sample from the Athabasca basin, Canada, contains both tv-
168 and cv-1M crystals, whereas the sample from Kombolgie, Australia, is essentially a $2M_1$ illite.
169 Samples were ultrasonically dispersed in de-ionized water and deposited on Cu-mesh grids coated
170 with a holey carbon membrane. SAED patterns were collected on Kodak negative films (Eastman
171 Kodak company, Rochester NY, USA) or with a GATAN CCD camera (Gatan, Pleasanton CA,
172 USA) using a Hitachi H9000 NAR transmission electron microscope (TEM, Hitachi, Okinawa,
173 Japan) equipped with a LaB₆ source and operated at 300 kV and a JEOL 2000fx LaB₆ TEM
174 operated at 200kV (Jeol, Tokyo, Japan). Complementary Precession ED patterns were acquired on
175 the Nant'Themis, a S/TEM Themis Z G3 (Thermo Fisher Scientific, Whaltman MA, USA) Cs-
176 probe corrected, monochromated, operated at 300 kV and equipped with a Complementary Metal
177 Oxide Semiconductor (CMOS) GATAN OneView camera and the 'Digistar' precession system
178 from NanoMEGAS SPRL (Bruxelles, Belgium).

179 RESULTS AND DISCUSSION

180 Finely dispersed mica crystals tend to settle on basal surfaces and lay on grids with the
181 c^* -direction quasi parallel to the electron beam. Intensity distributions of various polytypes
182 oriented along the c^* -axis are not sufficiently contrasting to allow for polytype/polymorph
183 identification, however (see below). Contrast is enhanced when microcrystals are oriented with
184 their [001], i.e., c -axis, parallel to the electron beam (Gaillot et al. 2011). Qualitative criteria based
185 on the intensity distribution over $hk0$ spots that are used for identification of the different mica
186 polymorphs and polytypes from their [001] ED patterns are given below.

187 *ED along [001]: geometry, symmetry and indexing*

188 Geometry of [001] ED patterns is similar and all models have the same pseudo-hexagonal
189 arrangement of $hk0$ reflections. Departure from hexagonal symmetry is marginal for $1M$, $2M_1$, and
190 $2M_2$ polytypes. For $1M$ and $2M_1$ polytypes, indexing was performed with an orthogonal $\mathbf{a}^*\mathbf{b}^*$ unit
191 cell with a C -centered lattice. For the $2M_2$ polytype ($a^* < b^*$), $h'k'$ indices are obtained from from
192 $h'k'$ indices of the $2M_1$ by $h' = k$ and $k' = -h$. The orthogonal cell was used for the $3T$ polytype
193 despite its hexagonal symmetry. All ED patterns present mirror planes perpendicular to \mathbf{a}^* - and
194 \mathbf{b}^* -axes, and $hk0$, $\bar{h}k0$, $h\bar{k}0$, and $\bar{h}\bar{k}0$ reflections are equivalent and are hereafter referred to as hk
195 reflections. Intensity distributions for hk reflections differ significantly for each polytype (Gaillot
196 et al. 2011).

197 *ED patterns calculated along [001] for 1M polymorphs*

198 *Pure tv- and cv-1M polymorphs.* ED patterns calculated along [001] for pure tv- and cv-
199 $1M$ micas were described by Gaillot et al. (2011). The intensity distribution depends on the layer
200 structure and the occupancy of M1 and M2 sites. For both polymorphs, 06 and 20 spots are strong
201 and 13 and 26 reflections have similar intermediate intensities. The main difference is the intensity
202 of 02 spots, which are much stronger than the 11 reflections for tv- $1M$ (Figs. 2a,f), whereas the
203 opposite is observed for cv- $1M$ layers (M2 or M2' site vacant, Figs. 2b,g). Similar intensity
204 distributions are obtained when considering M-layers and site occupancies matching those of pure
205 tv- and cv-layers [(0:1:1) and (1:0:1) occupancy probabilities, respectively, Figs. 3a,b].

206 *Partial occupation of octahedral sites.* Diffraction patterns for $1M$ crystals in which
207 octahedral vacancies are distributed with equal probability over the two symmetrically related *cis*
208 sites [M-cell with (1:0.5:0.5), Fig. 3c] are similar to that obtained where all vacancies occur in a
209 unique *cis* site (Fig. 2b), except for a limited weakening of 11 reflections and thus a lower contrast
210 with 02 reflections. Similar differences are observed for X-ray diffraction intensity distributions
211 calculated for tv and cv polymorphs (See for example Drits et al. 1984, 1993; Drits & McCarty

212 1996). Where tv and cv layers coexist with equal probability [M-cell (0.5:0.5:1), Fig. 2k], the
213 resulting ED pattern resembles that calculated for a pure tv layer (Fig. 2a). For a pure tv layer,
214 weaker 02 reflections occur, and a lower intensity contrast exists between 02 and 11 reflections.
215 Intensities of 11 and 02 reflections are identical for tv and cv layers occurring in a 1:2 ratio within
216 crystals. For a 1:2 tv:cv ratio, the intensity of 22 and 04 reflections are increased when vacancies
217 occur equally over the three octahedral sites [M-cell (0.67:0.67:0.67), Fig. 2l] compared to an
218 asymmetric distribution of vacancies over the two *cis* sites [M-cell (0.67:0.33:1), Fig. 3d].

219 *Identification criteria.* When oriented along the [001] zone axis, strong 20 and 06
220 reflections define a diamond-shaped distribution for 1M mica polymorphs (dashed line in Figs.
221 2f,g). In addition, two bright segments parallel to the \mathbf{a}^* -axis are defined by $26/06/\bar{2}6$ and $2\bar{6}/0\bar{6}/\bar{2}\bar{6}$
222 reflections. The ED pattern of the tv-1M polymorph is further characterized by a bright diamond
223 defined by 20 and 02 reflections and by two smaller and weaker diamonds defined by 02/13/04/ $\bar{1}\bar{3}$
224 and $0\bar{2}/\bar{1}\bar{3}/04/\bar{1}\bar{3}$ reflections. In contrast, the ED pattern of the cv-1M polymorph exhibits two
225 segments of strong reflections parallel to the \mathbf{b}^* -axis and formed by 13/11/ $\bar{1}\bar{1}/\bar{1}\bar{3}$ and $\bar{1}\bar{3}/\bar{1}\bar{1}/\bar{1}\bar{1}/\bar{1}\bar{3}$.
226 The intensity distribution of 02 and 11 reflections allows differentiating unambiguously pure tv-,
227 with strong 02 reflections, from pure cv-1M polymorphs, with strong 11 reflections. The 11 and 02
228 reflections are of equal intensity when the M1 and M2 sites are occupied with a ~1:2 ratio (Figs.
229 2l and 3d). Quantification of *trans* vs. *cis* site occupancy from experimental data remains
230 challenging however owing to the multiple factors influencing ED intensity distribution (see
231 below).

232 *ED patterns calculated along [001] and identification criteria for other tv/cv polytypes*

233 *2M₁ polymorphs.* The [001] ED pattern of tv-2M₁ polytype (Fig. 2c) contains three sets of
234 intense *hk* reflections ($06 > 20 \approx 40 > 11 \approx 26$). In contrast to 1M polymorphs, the strongest
235 reflections have the same indices for both tv- and cv-2M₁ (Fig. 2m). The 22 and 11 reflections are

236 slightly more intense for the cv - $2M_1$ polymorph compared to tv - $2M_1$. However, the small difference
237 in intensity makes the experimental differentiation of the two polymorphs difficult. ED patterns of
238 the $2M_1$ exhibits two segments of high-intensity reflections parallel to \mathbf{a}^* -axis (defined by $26/06/\bar{2}6$
239 and $2\bar{6}/0\bar{6}/\bar{2}\bar{6}$ reflections) similar to $1M$ varieties. In addition, a third segment of high-intensity
240 reflections parallel to the \mathbf{a}^* -axis is visible (defined by 40 and 20 reflections) together with two
241 triangles of relatively bright reflections ($11/1\bar{1}/20$ and $\bar{1}1/\bar{1}\bar{1}/0\bar{2}$). For tv - $2M_1$ polymorphs, these
242 two triangles include $22/2\bar{2}$ and $\bar{2}2/\bar{2}\bar{2}$ reflections, thus resulting in two enlarged and truncated
243 triangles (grey dotted lines in Fig. 2h).

244 *2M₂ polymorphs.* For the $2M_2$ polytype, the \mathbf{c} -axis forms an oblique angle with $[100]$,
245 which corresponds to the long \mathbf{a} -axis by convention, contrary to all other mica polytypes. To reach
246 the $[001]$ zone axis, mica crystals are tilted around the $[010]$ axis which is parallel to the long
247 reciprocal unit-cell vector \mathbf{v}_1^* . The $[001]$ ED pattern of tv - $2M_2$ polytype (Fig. 2d) contains three
248 sets of intense reflections: $31 > 11 \approx 04$ reflections. In addition, the 60 spots are weak, whereas 22,
249 40, and 13 reflections have intermediate intensity, and all other non-extinct hk reflections, including
250 20 spots, are faint. The ED patterns of the $2M_2$ differ from all other mica polytypes by the low
251 intensity of 60 reflections compared to other $h'k'$ reflections and by the absence of bright spots
252 aligned parallel to the \mathbf{b}^* -axis. Rather, the $2M_2$ is characterized by a large diamond shape defined
253 by 40 and 04 reflections that includes all reflections with non-negligible intensity (dashed line in
254 Fig. 2i). Differentiation of cv and tv with SAED is difficult although 31 reflections dominate the
255 ED pattern for the tv - $2M_2$ polymorph. These reflections define, together with weaker 11 reflections,
256 two segments of bright spots parallel to the \mathbf{a}^* -axis. For the cv - $2M_2$ polytype, the intensity of the
257 latter reflections is increased making these segments more visible (Fig. 2n). The intensity of 22
258 reflections is also increased slightly for the cv polymorph compared to the tv polymorph. When
259 vacancies are distributed with equal probability over the two *cis* sites [M-cell (1:0.5:0.5)], 20

260 reflections appear slightly more intense than 11 spots whereas other reflections are essentially
261 unaffected (not shown).

262 *3T polymorphs.* In contrast to previous cases, the [001] direction is parallel to both **c**- and
263 **c***-axes, and the ED pattern for tv-3*T* polytype (Fig. 2e) is hexagonal and exhibits six-fold
264 rotational symmetry, with very strong and of equal intensity 06 and 33 reflections, whereas 11, 02,
265 22, 04, 26, and 40 spots are weak (Fig. 2j). Vacancy location has a minor influence on the intensity
266 distribution over the ED pattern: 02 and 11 reflections are slightly more intense for the tv-3*T*
267 polymorph whereas 04, 22, 40, and 26 reflections are more intense for the cv-3*T* polymorph (Fig.
268 2o). These differences are not sufficient to allow experimental differentiation of tv-3*T* and cv-3*T*
269 polymorphs.

270 *Validity of identification criteria*

271 *Precession ED criteria.* Precession ED (PED) is increasingly used for structure
272 identification or refinement owing to the minimal influence of dynamical effects, with limited
273 electron beams being excited simultaneously (Vincent & Midgley 1994; Gjonnes et al. 1998;
274 Gemmi & Nicolopoulos 2007; Nicolopoulos et al. 2007; Moeck & Rouvimov 2010). These authors
275 showed that intensities are proportional to the structure factor amplitude rather than to its squared
276 value as in conventional ED. Although PED intensities are not equal to the present calculations,
277 qualitative distribution of intensity among bright and weak beams are similar, and identification
278 criteria established above for SAED remain valid (Fig. 1).

279 *Qualitative vs. quantitative criteria.* Qualitative, rather than quantitative, identification
280 criteria are proposed in the present work (Figs. 2f-j) because of the limited availability of cameras
281 with sensor dynamics to allow the recording of high-quality ED patterns. In addition, qualitative
282 criteria allow a quick assessment of the polytypic form during observation and a real-time decision
283 for data collection strategy. More importantly, and as discussed hereafter, numerous parameters

284 influence actual ED intensities beside the crystal structure: i) crystal thickness, which is possible
285 to assess in the microscope by using electron-energy loss spectroscopy (EELS) and analyzing the
286 plasmon peak, or by using beforehand shadowing treatment of the sample; ii) chemical
287 composition, with the implicit requirement of systematic energy dispersive X-ray spectroscopy;
288 and iii) nature and number of structural defects (i.e., random or well-defined translational or
289 rotational stacking faults, interstratification of cv- and tv-layers or of polytypic fragments, etc.).
290 Consequently, systematic quantitative processing of diffracted intensities is unrealistic whereas
291 qualitative identification criteria are useful for polytypic and polymorphic varieties of dioctahedral
292 K-bearing aluminous mica, if only few defects are present and if the mica occurs as thin flat
293 crystals. Intensity ratios may be used to determine structure details, such as the relative proportion
294 of cv and tv layers in 1M crystals from the intensity ratio between 02 and 11 reflections (Figs. 2k,l).

295 *Influence of crystal thickness.* ED intensities were calculated here with the kinematical
296 approximation, thus neglecting multiple scattering events that may occur for thick crystals as
297 described by Gaillot et al. (2011). In the absence of beam precession capability to minimize
298 multiple scattering effects, crystal thickness can be estimated *in situ* EELS. Alternatively, the low
299 intensity of diffracted beams compared to the direct beam will ensure that crystals are sufficiently
300 thin to interpret intensity distribution among hkl spots (h and $k \leq 6$). In any case, reported intensity
301 distributions based on kinematical approximation, are probably sufficient to qualitatively interpret
302 SAED patterns and to identify polytypes and polymorphs for most crystals of microcrystalline
303 micas, containing mostly light elements (Gaillot et al. 2011).

304 *Influence of local unit-cell distortions.* Except for the 1M polytype, structure models
305 (Zhoukhlisov et al. 1973, 1974; Drits et al. 1984, 2010a, 2010b; Amisano-Canesi et al. 1994; Liang
306 et al. 1998) used for the calculations reported here were systematically refined for tv layer
307 configuration. As noted above, diffraction effects from cv polymorphs and structures where tv and

308 cv layers coexist were calculated by varying the w_i occupancy of M1, M2, and M2' sites without
309 adjustment of atomic positions. Comparison of ED patterns calculated for tv-1M and cv-1M models
310 with adjustment of atomic positions and for the average M-layer with equivalent octahedral site
311 occupancies (0:1:1 and 1:0:1, respectively) indicates the sensitivity of ED patterns to local
312 distortions within the unit cell (Figs. 3a,b). This influence remains limited, however, and qualitative
313 identification criteria remain valid for cv polymorphs of 2M and 3T polytypes. Similarly, local
314 distortions induced by cationic substitutions can be ignored as a first approximation. However, as
315 the occupancy of M2 and M2' sites within cv-1M crystals influences the intensity distribution, the
316 coexistence of vacant M2 and M2' sites within cv-1M crystals possibly accounts for the
317 experimental absence of expected dynamical effects, such as center of symmetry loss for cv layers
318 (Gaillot et al. 2011).

319 *Influence of crystal bending.* Owing to the size of the selected-area aperture, ED intensities
320 are averaged over a large surface area of the crystal (typically ~200 nm in diameter, although a
321 smaller aperture can be used, if available). Variation in surface orientation with respect to the
322 electron beam, often revealed by bending contours in the image, results in diffracted intensities
323 being averaged, similar to mosaicity effects. Moving a small aperture over the crystal allows
324 assessing the effect of bending. For investigated crystals, diffraction mapping at the nanoscale
325 showed that the orientation fluctuation remains $<1-2^\circ$ (not shown). As long as the crystal surface
326 bending is small ($<1-2^\circ$), a distinctive pattern of a given polytype should be recognizable.

327 *Influence of chemical composition on dioctahedral mica ED patterns*

328 Mg^{2+} -for- Al^{3+} or Al^{3+} -for- Si^{4+} substitutions in octahedral and tetrahedral sheets have
329 marginal influence on diffracted intensity distributions owing to the similar scattering factors of
330 involved cations. Other cation substitutions are frequent in natural dioctahedral micas, the most
331 common being Na^+ -for- K^+ in paragonite and the partial substitution of $\text{Fe}^{2+}/\text{Fe}^{3+}$ for Al^{3+} in illite

332 and phengite, and in celadonite and glauconite (Bailey 1984; Mottana et al. 2004). The influence
333 of Na⁺-for-K⁺ and Fe²⁺/Fe³⁺-for-Al³⁺ substitutions on ED intensity is described below for the mica
334 polytypes. Expected lattice distortions induced by cationic radii variations or vacant octahedral
335 sites are not considered owing to their limited effect on diffraction intensity.

336 *Na-bearing aluminous dioctahedral mica.* Intensity distributions among *hk* reflections
337 calculated for tv-1*M*, cv-1*M*, tv-2*M*₁, tv-2*M*₂, and tv-3*T* structure models and an idealized
338 paragonite composition (Na^[VI]Al₂^[IV]Si₄O₁₂, Figs. 4a-e) differ slightly from a muscovite
339 composition (K^[VI]Al₂^[IV]Si₄O₁₂, Figs. 2a-e). However, 02 and/or 11 reflections are stronger for
340 Na vs. K micas, whereas 06 reflections are weaker. Furthermore, because 02 reflections dominate
341 the tv-1*M* ED pattern, and 11 reflections dominate the cv-1*M* polymorph, the difference between
342 tv-vs. cv-1*M* is enhanced for sodic micas.

343 *K-bearing ferruginous dioctahedral mica.* Differences in intensity distributions calculated
344 for tv-1*M*, cv-1*M*, tv-2*M*₁, tv-2*M*₂ and tv-3*T* models and either an idealized celadonite composition
345 (K^[VI]Fe₂^[IV]Si₄O₁₂, Figs. 4f-j) or a muscovite composition (Figs. 2a-e) are marginal despite the
346 scattering contrast between Fe and Al/Mg. For example, [001] ED patterns are similar for
347 ferruginous and aluminous varieties of tv-3*T* and tv-2*M*₂ micas. For tv-2*M*₁ micas, all reflections
348 but 06 and 40 are weaker for the ferruginous variety compared to the aluminous mica, whereas for
349 tv-1*M* and cv-1*M* polymorphs, 13 reflections are weaker and 26 spots stronger for the ferruginous
350 mica compared to the aluminous mica. In all cases, the overall intensity distribution, and the sets
351 of bright *hk* spots are similar for both ferruginous and aluminous varieties.

352 *ED patterns along other crystal orientations*

353 Except for the 3*T* polytype, whose **c**-axis is perpendicular to the layer plane, all mica
354 crystals must be rotated to be oriented along the [001] axis, the direction of which is unknown a

355 priori. To reach the [001] axis, which forms an oblique angle with [100] (Fig. 5a), crystals that lay
356 on the **ab**-plane must be rotated by a θ_{th} angle around the [010] axis. Two directions of rotation
357 ($\pm\theta$) are possible to reach the [001] zone axis. In practice, the closest zone axis is easily reached,
358 but may differ from the [001] axis. Indeed [001] and [101] axis are tilted at about the same angle
359 ($\sim 10^\circ$) in opposite directions for 1M polytypes. To more rapidly allow for a correct identification
360 of SAED patterns oriented along [001], additional calculations were performed along a selection
361 of $[hkl]$ zone axes near the **c**-axis (Fig. 5a). Theoretical θ_{th} angles between the **c***-axis and $[hkl]$
362 directions are provided in Figures 6-7, although experimentally determined values may deviate
363 slightly if crystals are not normal to the electron beam.

364 *ED patterns calculated along the c*-axis.* The **c***-axis is close to [103] for 1M, 2M₁, and
365 2M₂ polytypes ($\theta_{\text{th}} \leq 1.5^\circ$) and perpendicular to the 2:1 layers, thus producing hexagonal ED
366 patterns, similar to the 3T polytype along [001]. For all polytypes, hk reflections from the third
367 hexagon (06 and 33 reflections) are of equal intensity and dominate the ED pattern (Figs. 6a-e).
368 The ED pattern calculated for the 3T polytype is the only ED showing a six-fold axis, whereas
369 those calculated for monoclinic polytypes (1M, 2M₁, and 2M₂) exhibit two mirror planes normal to
370 **a**_{//}* (projection of **a*** on the ZOLZ plane) and **b*** vectors, hkl reflections with $h = 3n$ being the only
371 ones observed. For well-ordered crystals, extinction rules can be used as an identification criterion.
372 Extinction rules may be violated, owing to reciprocal lattice node elongation for defective or very
373 thin crystals.

374 *Tilt around [010].* The geometry and intensity distributions of calculated ED patterns
375 depend on the $[u0w]$ zone axis considered. As a rule, relative intensities of $0k0$ spots along the
376 common **b***-axis are preserved. For crystals oriented along the [102] zone axis, the ZOLZ also
377 contains $-2l\ k\ l$ reflections (with the $h + k = -w \times l + k = 2n$ extinction rule from C-centering). hk
378 reflections with $h \neq 2l$ do not theoretically appear (unless the reciprocal rods are sufficiently

379 elongated) leading to rectangular patterns of the brightest spots (Figs. 6f-j). For increasing tilt
380 values (Fig. 5a), the geometry of $[101]$ and $[\bar{1}01]$ ED patterns (Figs. 6k-t) remains similar to that
381 of patterns calculated along $[001]$ (Figs. 2a-e) with only a faint stretching along the $a//^*$ direction.
382 This elongation becomes significant for ED patterns calculated along $[h0\ell]$ with $|h| \geq 2$, although
383 the intensity distribution may be still useful for polytype identification (Figs. 7a-o). ED patterns
384 calculated along other $[h0\ell]$ axes are less informative. ED patterns for $tv-2M_1$ along $[101]$ and for
385 $cv-1M$ along $[001]$ are alike (Figs. 6m and 4b, respectively), as are those for $tv-3T$ along $[101]$ and
386 for $1M$ with the vacancies equally distributed over the three octahedral sites (Figs. 6o and 4l).
387 Similarly, ED patterns for $tv-2M_1$ along $[\bar{1}01]$ and for $cv-1M$ along $[101]$ are alike (Figs. 6r and
388 6l), as are those for $tv-3T$ along the \mathbf{c} - or \mathbf{c}^* -axis and for $tv-1M$, $cv-1M$, and $tv-2M_1$ along $[103]$, at
389 least for the intensity distribution among most intense reflections (Figs. 6e and 6a-c, respectively).
390 These similarities may require recording an additional ED pattern along another $[10w]$ ZA to
391 determine the $[001]$ axis.

392 *Tilt around $[100]$.* ED patterns calculated along $[011]$ for $tv-1M$, $cv-1M$, $tv-2M_1$, $tv-2M_2$,
393 and $tv-3T$ polytypes are shown in Figure 7p-t. For monoclinic polytypes, $[001]$ and $[100]$ form an
394 oblique angle. The angle between $\mathbf{a}//^*$ and \mathbf{b}^* -axis thus differs from 90° and ED patterns calculated
395 along $[011]$ appear significantly distorted. In addition, ED patterns calculated along $[0k1]$, with $k \neq$
396 0, possess lower symmetry than those calculated along $[001]$ and the former no longer present
397 mirror planes (even for the $3T$ polytype) because intensities of hkl , $h\bar{k}\bar{\ell}$, and equivalent reflections
398 are no longer equal. The center of symmetry is preserved however with $I(hkl) = I(\bar{h}\bar{k}\bar{\ell})$ for
399 kinematical diffraction (Friedel's law). Symmetry lowering makes ED patterns recorded along
400 $[0k1]$ recognizable.

401 *Advanced identification method*

402 Different polytypes can have similar ED patterns along different zone axes, thus impairing
403 polytype identification if the [001] zone axis is not correctly determined. Although complementary
404 powder X-ray diffraction data indicate the major polytypes present in a sample, a suitable
405 orientation along [001] is key to avoid polytype misidentification using the proposed criteria (Figs.
406 2f-j). Orientation along [001] relies on the correct identification of the [010] rotation axis and on
407 the inclination θ of the zone axis relative to the \mathbf{c}^* -axis. ED patterns along several crystallographic
408 directions can be useful to further constrain polytype/polymorph identification if the crystal
409 orientation is uncertain.

410 *Experimental considerations.* In practice, determining the appropriate rotation direction
411 to reach the [001] axis can be challenging. A large number of stacking faults present may negate
412 any effort, however, as the [001] direction is not unique, and thus thin crystals are usually preferred.
413 Crystal morphology is also used to determine ED pattern orientation in the \mathbf{a}^* - \mathbf{b}^* -plane because
414 unit-cell \mathbf{a} or \mathbf{b} vectors are often parallel to a crystal edge. In addition, illite lath-shaped crystals
415 grow parallel to the [100] (Rex 1964), and the [001] axis can be reached by rotating the crystal
416 around the direction parallel to the short dimension (Figs. 8a-b). There is no absolute method to
417 determine a priori how the rotation should be performed and a trial-and-error approach is necessary.
418 However, the [001] ED patterns must possess two perpendicular mirror planes common to all
419 patterns oriented along $[u0w]$ axes. If this symmetry is fulfilled, experimental SAED pattern can
420 be compared with calculated patterns (Figs. 2 and 6) for identification. Additional tilt in the same
421 or opposite directions allows reaching other $[u0w]$ orientations to confirm polytype identification.

422 *Experimental zone axis angle.* Ideally, the \mathbf{b}^* -axis is aligned with the sample holder
423 primary rotation axis (the “Tilt” axis) and the tilt angle to reach the desired $[u0w]$ orientation can
424 be compared directly to the theoretical θ_{th} value (indicated in the figures). In practice, this is

425 achieved with a “Tilt-Rotation” holder that allows rotating the sample within the observation plane.
 426 With commonly available “Double Tilt” holders, obtaining the correct orientation requires
 427 combining two rotation axes (Tilt and Azimuth angles, Fig. 5b), both normal to the electron beam.
 428 In cylindrical coordinates, the inclination of the ED pattern zone axis with respect to the crystal \mathbf{c}^* -
 429 axis is defined by two angles: θ and Ω , the angles with the z-direction and between the projection
 430 of the zone axis on the \mathbf{ab} -plane and the sample holder primary rotation (tilt) x-axis, respectively.
 431 Experimental Ω and θ angles can be computed from sample holder tilt (Tt) and azimuth (Az)
 432 rotation angles using the following equations:

$$433 \quad \frac{d_y}{d_x} = \tan \Omega = \frac{\tan Tt}{\tan Az}, \Omega = 90^\circ \text{ if } Az = 0^\circ \quad (3)$$

$$434 \quad \frac{d_x^2 + d_y^2}{h^2} = \tan^2 \theta = \tan^2 Az + \tan^2 Tt \quad (4)$$

435 where d_x , d_y , h are the coordinates (in Å) of a virtual point (M) on the zone axis, along the two
 436 rotation axes (x, y) and the electron beam (z) directions, respectively (Fig. 5c). Conversely, it is
 437 possible to calculate Tt and Az values to be used experimentally from the θ and Ω angles of the
 438 sought zone axis:

$$439 \quad \tan Tt = \frac{\tan \theta \cdot \tan \Omega}{\sqrt{1 + \tan^2 \Omega}} \quad (5)$$

$$440 \quad \tan Az = \frac{\tan \theta}{\sqrt{1 + \tan^2 \Omega}} \quad (6)$$

441 These equations may aid in finding the orientation of the first $[u0w]$ zone axis from the
 442 initial crystal orientation with the \mathbf{c}^* -axis close to the beam direction. The equations can also be
 443 used for multiple zone-axis data collection. In the latter case, the crystal shift upon tilting must be
 444 compensated if the crystal is not flat. To illustrate, SAED patterns were obtained for two

445 orientations from isomorphic plates of illite from Kombolgie (Figs. 8c-d). For both patterns, the
446 $|\theta_{\text{exp}}|$ angle calculated from the TEM holder angles ($\sim 12^\circ$ and 3° , respectively) is consistent with
447 the theoretical $|\theta_{\text{th}}|$ value calculated for the [101] and [001] ZA of the $2M_1$ polytype ($\sim 9^\circ$ and 6° ,
448 respectively), thus obtaining a determination of the $2M_1$ polytype, despite the minor discrepancy
449 between experimental and calculated tilt angles.

450 SUMMARY AND PERSPECTIVES

451 Qualitative criteria are provided to determine the polymorph/polytype of individual
452 crystals of K-bearing aluminous dioctahedral micas from the intensity distribution of hk reflections
453 from the zero-order Laue zone. Differences are enhanced for ED patterns calculated along the [001]
454 zone-axis. ED patterns calculated along adjacent zone-axes are provided to avoid potential
455 difficulties in obtaining unambiguously the optimum [001] orientation. The method allows
456 retrieving morphological and structural information from individual mica crystals. Matching the
457 observed data to calculated patterns allows the determination of structural information from K-
458 bearing aluminous mica crystals (illite, muscovite, or phengite), including morphology and
459 possibly chemistry (Lanson et al. 1996, 2002; Patrier et al. 2003; Laverret et al. 2006).

460 ACKNOWLEDGMENTS

461 Daniel Beaufort (IC2MP, Poitiers – France) is thanked for providing the $1M$ illite and $2M_1$
462 muscovite samples. Funded by the French Contrat Plan État-Région and the European Regional
463 Development Fund of Pays de la Loire, the CIMEN Electron Microscopy Center in Nantes is
464 greatly acknowledged. ISTERre is part of Labex OSUG@2020 (ANR10 LABX56). Comments by
465 two anonymous reviewers improved and clarified the initial manuscript. On behalf of all authors,
466 the corresponding author states that there is no conflict of interest.

- 468 Amisano-Canesi, A., Chiari, G., Ferraris, G., Ivaldi, G., & Soboleva, S.V. (1994) Muscovite-3T
469 and phengite-3T - crystal-structure and conditions of formation. *European Journal of*
470 *Mineralogy*, 6, 489-496.
- 471 Bailey, S.W. (1984) Classification and structure of the micas. Pp. 1-12. In S.W. Bailey, Ed. *Micas*,
472 13, Mineralogical Society of America, Chantilly, Va.
- 473 Bailey, S.W. (1988) *Hydrous phyllosilicates (exclusive of micas)*. Pp. 725. Mineralogical Society
474 of America, Chantilly, Va.
- 475 Beermann, T. & Brockamp, O. (2005) Structure and analysis of montmorillonite crystallites by
476 convergent-beam electron diffraction. *Clay Minerals*, 40, 1-13.
- 477 Drits, V.A. (1987) *Electron diffraction and high-resolution electron microscopy of mineral*
478 *structures*. Pp. 304. Spring-Verlag, New-York.
- 479 Drits, V.A. & McCarty, D.K. (1996) The nature of diffraction effects from illite and illite-smectite
480 consisting of interstratified trans-vacant and cis-vacant 2:1 layers: A semiquantitative
481 technique for determination of layer-type content. *American Mineralogist*, 81, 852-863.
- 482 Drits, V.A. & Sakharov, B.A. (2004) Potential problems in the interpretation of powder X-ray
483 diffraction patterns from fine-dispersed 2M₁ and 3T dioctahedral micas. *European Journal*
484 *of Mineralogy*, 16, 99-110.
- 485 Drits, V.A., Plançon, A., Sakharov, B.A., Besson, G., Tsipursky, S.I., & Tchoubar, C. (1984)
486 Diffraction effects calculated for structural models of K-saturated montmorillonite
487 containing different types of defects. *Clay Minerals*, 19, 541-562.

- 488 Drits, V.A., Weber, F., Salyn, A.L., & Tsipursky, S.I. (1993) X-ray identification of one-layer illite
489 varieties: Application to the study of illites around uranium deposits of Canada. *Clays and*
490 *Clay Minerals*, 41, 389-398.
- 491 Drits, V.A., Lindgreen, H., Salyn, A.L., Ylagan, R.F., & McCarty, D.K. (1998) Semiquantitative
492 determination of *trans*-vacant and *cis*-vacant 2:1 layers in illites and illite-smectites by
493 thermal analysis and X-ray diffraction. *American Mineralogist*, 83, 1188-1198.
- 494 Drits, V.A., Ivanovskaya, T.A., Sakharov, B.A., Zvyagina, B.B., Derkowski, A., Gor'kova, N.V.,
495 Pokrovskaya, E.V., Savichev, A.T., & Zaitseva, T.S. (2010a) Nature of the structural and
496 crystal-chemical heterogeneity of the Mg-rich glauconite (Riphean, Anabar uplift).
497 *Lithology and Mineral Resources*, 45, 555-576.
- 498 Drits, V.A., Zviagina, B.B., McCarty, D.K., & Salyn, A.L. (2010b) Factors responsible for crystal-
499 chemical variations in the solid solutions from illite to aluminoceladonite and from
500 glauconite to celadonite. *American Mineralogist*, 95, 348-361.
- 501 Emmerich, K., Madsen, F.T., & Kahr, G. (1999) Dehydroxylation behavior of heat-treated and
502 steam-treated homoionic *cis*-vacant montmorillonites. *Clays and Clay Minerals*, 47, 591-
503 604.
- 504 Gaillot, A.-C., Drits, V.A., Veblen, D.R., & Lanson, B. (2011) Polytype and polymorph
505 identification of finely divided aluminous dioctahedral mica individual crystals with SAED.
506 Kinematical and dynamical electron diffraction. *Physics and Chemistry of Minerals*, 38,
507 435-448.
- 508 Gemmi, M. & Nicolopoulos, S. (2007) Structure solution with three-dimensional sets of precessed
509 electron diffraction intensities. *Ultramicroscopy*, 107, 403-494.

510 Gjonnes, J., Hansen, V., Berg, B.S., Runde, P., Cheng, Y.E., Gjonnes, K., Dorset, D.L., & Gilmore,
511 C.J. (1998) Structure model for the phase Al_mFe derived from three-dimensional electron
512 diffraction intensity data collected by a precession technique. Comparison with convergent-
513 beam diffraction. *Acta Crystallographica*, A54, 306-319.

514 Kameda, J., Miyawaki, R., Kitagawa, R., & Kogure, T. (2007) XRD and HRTEM analyses of
515 stacking structures in sudoite, di-trioctahedral chlorite. *American Mineralogist*, 92, 1586–
516 1592.

517 Kogure, T. & Banfield, J.F. (1998) Direct identification of the six polytypes of chlorite
518 characterized by semi-random stacking. *American Mineralogist*, 83, 925-930.

519 Kogure, T. & Drits, V.A. (2010) Structural change in celadonite and *cis*-vacant illite by electron
520 radiation in TEM. *Clays and Clay Minerals*, 58, 522-531.

521 Kogure, T. & Kameda, J. (2008) High-resolution TEM and XRD simulation of stacking disorder
522 in 2:1 phyllosilicates. *Zeitschrift für Kristallographie*, 223, 69-75.

523 Kogure, T. & Nespolo, M. (1999) First occurrence of a stacking sequence including (+60°, 180°)
524 rotations in Mg-rich annite. *Clays and Clay Minerals*, 47, 784-792.

525 Kogure, T., Kameda, J., & Drits, V.A. (2008) Stacking faults with 180° layer rotation in celadonite,
526 an Fe- and Mg-rich dioctahedral mica. *Clays and Clay Minerals*, 56, 612-621.

527 Lanson, B., Beaufort, D., Berger, G., Baradat, J., & Lacharpagne, J.-C. (1996) Illitization of
528 diagenetic kaolinite-to-dickite conversion series: Late-stage diagenesis of the lower
529 Permian Rotliegend sandstone reservoir, offshore of The Netherlands. *Journal of*
530 *Sedimentary Research*, 66, 501-518.

- 531 Lanson, B., Beaufort, D., Berger, G., Bauer, A., Cassagnabere, A., & Meunier, A. (2002)
532 Authigenic kaolin and illitic minerals during burial diagenesis of sandstones: A review.
533 *Clay Minerals*, 37, 1-22.
- 534 Laverret, E., Patrier Mas, P., Beaufort, D., Kister, P., Quirt, D., Bruneton, P., & Clauer, N. (2006)
535 Mineralogy and geochemistry of the host-rock alterations associated with the Shea creek
536 unconformity-type uranium deposits (Athabasca basin, Saskatchewan, Canada). Part 1.
537 Spatial variation of illite properties. *Clays and Clay Minerals*, 54, 275-294.
- 538 Liang, J.J., Hawthorne, F.C., & Swainson, I.P. (1998) Triclinic muscovite: X-ray diffraction,
539 neutron diffraction and photo-acoustic FTIR spectroscopy. *Canadian Mineralogist*, 36,
540 1017-1027.
- 541 McCarty, D.K. & Reynolds, R.C., Jr. (1995) Rotationally disordered illite/smectite in paleozoic K-
542 bentonites. *Clays and Clay Minerals*, 43, 271-284.
- 543 Moeck, P. & Rouvimov, S. (2010) Precession electron diffraction and its advantages for structural
544 fingerprinting in the transmission electron microscope. *Zeitschrift für Kristallographie*, 225,
545 110–124.
- 546 Mottana, A., Sassi, F.P., Thompson, J.B., Jr, & Guggenheim, S. (2004) *Micas: Crystal chemistry*
547 *and metamorphic petrology*. Pp. 499. Mineralogical Society of America, Chantilly, Va.
- 548 Nicolopoulos, S., Morniroli, J.-P., & Gemmi, M. (2007) From powder diffraction to structure
549 resolution of nanocrystals by precession electron diffraction. *Zeitschrift für Kristallographie*.
550 *Supplement issue 26*, 183-188.
- 551 Patrier, P., Beaufort, D., Laverret, E., & Bruneton, P. (2003) High-grade diagenetic dickite and
552 $2M_1$ illite from the middle Proterozoic Kombolgie formation (Northern Territory,
553 Australia). *Clays and Clay Minerals*, 51, 102-116.

- 554 Rex, R.W. (1964) Authigenic kaolinite and mica as evidence for phase equilibria at low
555 temperature. *Clays and Clay Minerals*, 13, 95-104.
- 556 Stadelmann, P. (1999) Electron Microscopy Suite, Java version (JEMS). CIME-EMPL,
557 Switzerland.
- 558 Vincent, R. & Midgley, P.A. (1994) Double conical beam-rocking system for measurement of
559 integrated electron diffraction intensities. *Ultramicroscopy*, 53, 271-282.
- 560 Ylagan, R.F., Altaner, S.P., & Pozzuoli, A. (2000) Reaction mechanisms of smectite illitization
561 associated with hydrothermal alteration from ponza island. *Clays and Clay Minerals*, 48,
562 610-631.
- 563 Zhoukhlistov, A.P., Zvyagin, B.B., Soboleva, S.V., & Fedotov, A.F. (1973) The crystal structure
564 of the dioctahedral mica $2M_2$ determined by high voltage electron diffraction. *Clays and*
565 *Clay Minerals*, 21, 465-470.
- 566 Zhoukhlistov, A.P., Zvyagin, B.B., Soboleva, S.V., & Fedotov, A.F. (1974) Structure of a
567 dioctahedral mica $2M_2$ according to high-voltage electron diffraction data (in Russian).
568 *Doklady Akademii Nauk SSSR*, 219, 704-707.
- 569 Zviagina, B.B., Sakharov, B.A., & Drits, V.A. (2007) X-ray diffraction criteria for the
570 identification of *trans*- and *cis*-vacant varieties of dioctahedral micas. *Clays and Clay*
571 *Minerals*, 55, 467-480.
- 572

574 Figure 1. **(a)** Transmission electron micrograph of an isomorphous illite particle from Athabasca
 575 Basin. **(b-c)** Corresponding experimental SAED patterns along [001] acquired on the circled zone
 576 and recorded **(b)** without precession, and **(c)** with a 2° angle precession of the electron beam.

577 Figure 2. ED patterns calculated using the kinematical approximation along the [001] zone axis for
 578 different polymorphs/polytypes: **(Left, from a-e)** $tv-1M$; $cv-1M$; $tv-2M_1$; $tv-2M_2$; $tv-3T$. Numerical
 579 values indicate the theoretical θ_{th} angle between the [001] zone axis and the normal to the **ab**-plane
 580 of the crystal. **(Middle, from f-j)** Corresponding schematic identification diagrams. Disk diameter
 581 and grey-scale intensity correspond to the intensity scale of the main $hk0$ reflections. Solid lines
 582 connect most intense $hk0$ reflections. **(Right)** Additional ED calculations: **(k)** $1M$ polytype
 583 considering M-cell (0.5:0.5:1); **(l)** $1M$ polytype considering M-cell (0.67:0.67:0.67); **(m)** $cv-2M_1$
 584 polymorph; **(n)** $cv-2M_2$ polymorph; **(o)** $cv-3T$ polymorph.

585 Figure 3. ED patterns calculated using the kinematical approximation along the [001] zone axis for
 586 the $1M$ polytype considering the M-cell, for different occupancies ($w_1:w_2:w_2'$) of the octahedral
 587 M1, M2 and M2' sites : **(a)** pure tv model with M1 site empty (0:1:1); **(b)** pure cv model with M2
 588 site empty (1:0:1); **(c)** cv model with the M2 and M2' sites equally vacant (1:0.5:0.5); **(d)** model
 589 with an asymmetrical distribution of vacancies (0.67:0.33:1) as occurring when tv and cv layers
 590 occur in a 1:2 ratio within the crystal. hk indices are given for the brightest spots ($\ell = 0$).

591 Figure 4. ED patterns calculated along the [001] zone axis for different polytypes and polymorphs
 592 of **(left)** Na-rich aluminous dioctahedral mica ($NaAl_2Si_4O_{12}$) and **(right)** K-rich ferrous
 593 dioctahedral mica ($KFe_2Si_4O_{12}$). **(a-e and f-j)** $tv-1M$; $cv-1M$; $tv-2M_1$; $tv-2M_2$; $tv-3T$. Unit-cell axes
 594 for $cv-1M$, $tv-2M_1$ and $tv-3T$ are identical to $tv-1M$.

595 Figure 5. (a) Orientation of different zone axes with respect to the \mathbf{a} (or \mathbf{a}') = [100] and \mathbf{c} = [001]
596 axes of the mica unit cell shown in projection along the \mathbf{b} - (or \mathbf{b}' -) axis. (b) Direction of tilt (Tt)
597 and azimuth (Az) rotation angles for a double-tilt sample holder. (c) Decomposition of the θ angle
598 between considered zone axis and the electron beam direction on both Tt and Az rotation angles of
599 the TEM holder shown in (b).

600 Figure 6. ED patterns calculated for various mica polymorphs and polytypes along different zone
601 axes: (from left to right) [103] (except for (e) [001]); [102]; [101] and $[1; \bar{0}1]$ ZA. (top to bottom)
602 tv -1M; cv -1M; tv -2M₁; tv -2M₂; tv -3T. Unit-cell vectors for cv -1M, tv -2M₁ and tv -3T are identical
603 to tv -1M. Numerical values as in Fig. 1. hk indices are indicated above the brightest reflexions,
604 their l indices on the side for tv -1M (same for (below for 2M₂)).

605 Figure 7. ED patterns calculated for various mica polymorphs and polytypes along different zone
606 axes: (from left to right) [201]; [301]; $[2; \bar{0}1]$ and [011] ZA. (top to bottom) tv -1M; cv -1M; tv -
607 2M₁; tv -2M₂; tv -3T. Unit-cell vectors and numerical values as in Figs. 1 and 4.

608 Figure 8. (a) Transmission electron micrographs of Athabasca Basin illite isomorphous and lath-
609 shaped crystals; (b) Experimental SAED along [001] from the circled zone of the lath crystal with
610 $|\theta| \sim 10^\circ$; (c-d) Experimental SAED along [101] and [001] respectively of isomorphous Kombolgie
611 illite crystal with experimental Tilt and Azimuthal TEM holder angles, and corresponding ZA
612 inclination $|\theta_{\text{exp}}|$ with respect to \mathbf{c}^* -axis deduced from Eqs. 3-4.

613 Table 1. Unit-cell parameters for tv-1*M*, cv-1*M*, tv-2*M*₁ and tv-3*T* polytypes ($\alpha = \beta = 90^\circ$)

Polytype	a (Å)	b (Å)	c (Å)	γ (°)
tv-1 <i>M</i>	5.199	9.005	10.164	101.3
cv-1 <i>M</i>	5.199	9.005	10.090	99.13
M-layer	5.199	9.005	10.12	99.86
tv-2 <i>M</i> ₁	5.177	8.987	20.072	95.76
tv-2 <i>M</i> ₂ [*]	9.023	5.197	20.171	99.48
tv-3 <i>T</i>	5.212	9.027	29.804	90

* Unit-cell parameters listed in the Russian version of the article (Zhoukhlistov *et al.*, 1973) slightly differ from those reported in an earlier English version and found in the ICSD database (#89823)

614

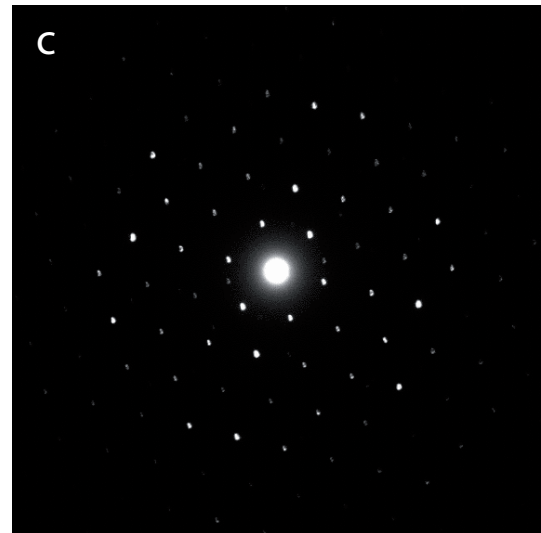
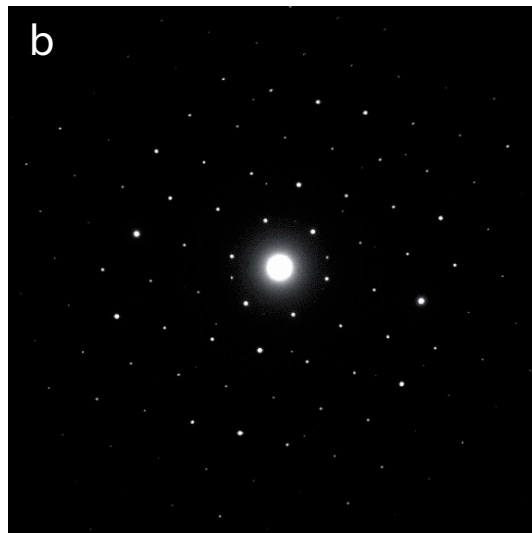
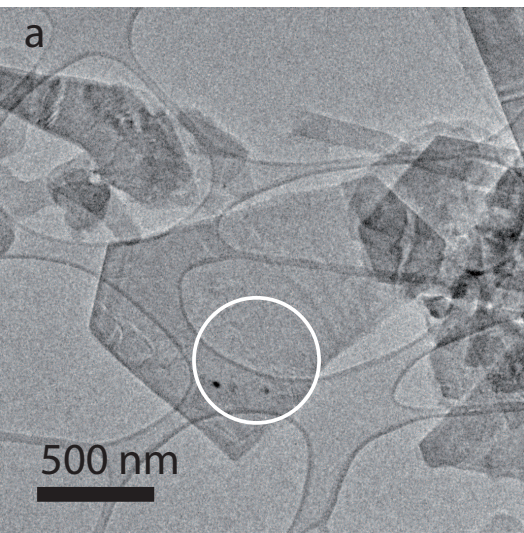

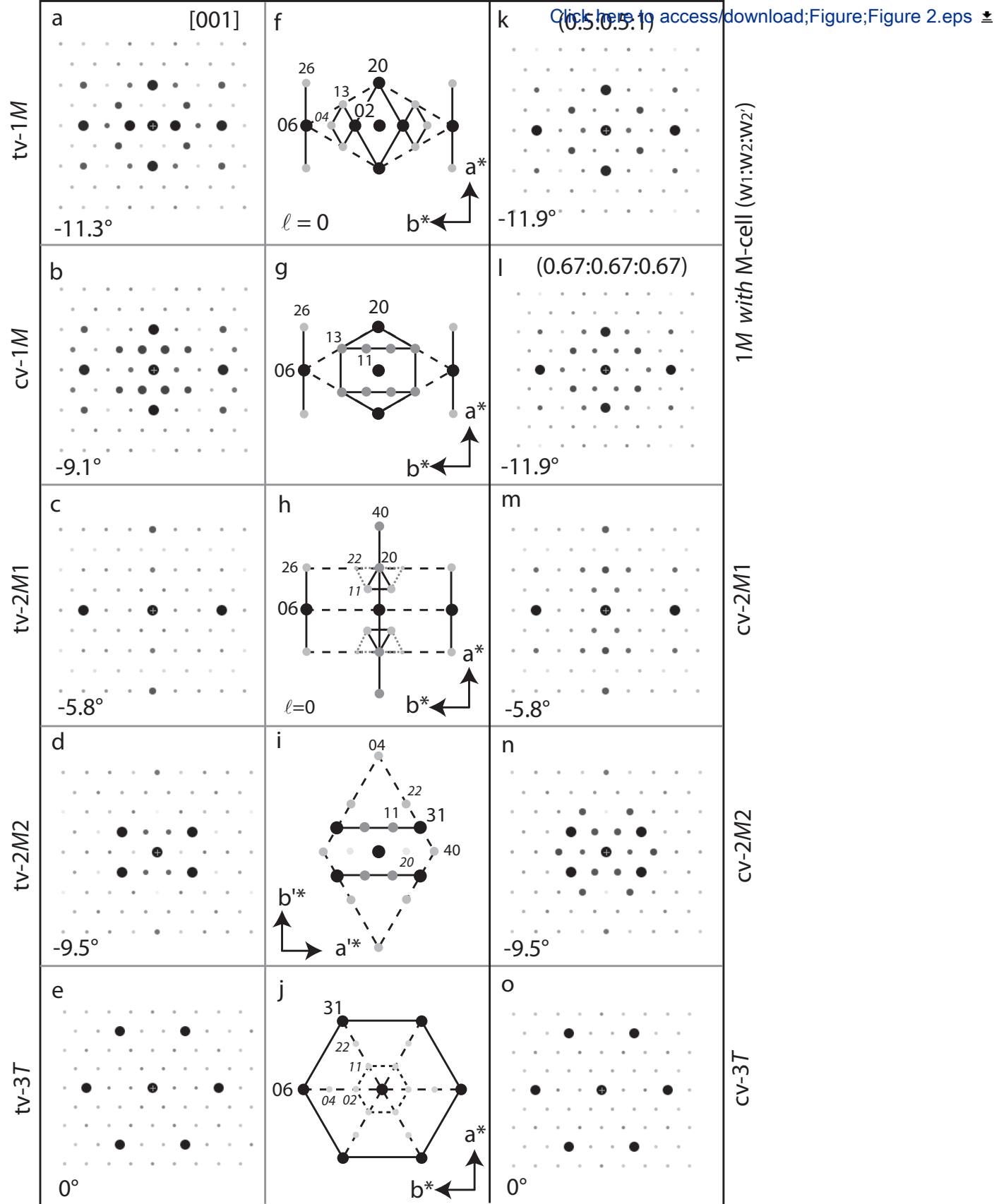

1M with M-cell ($w_1:w_2:w_2'$) [001] $\ell = 0$

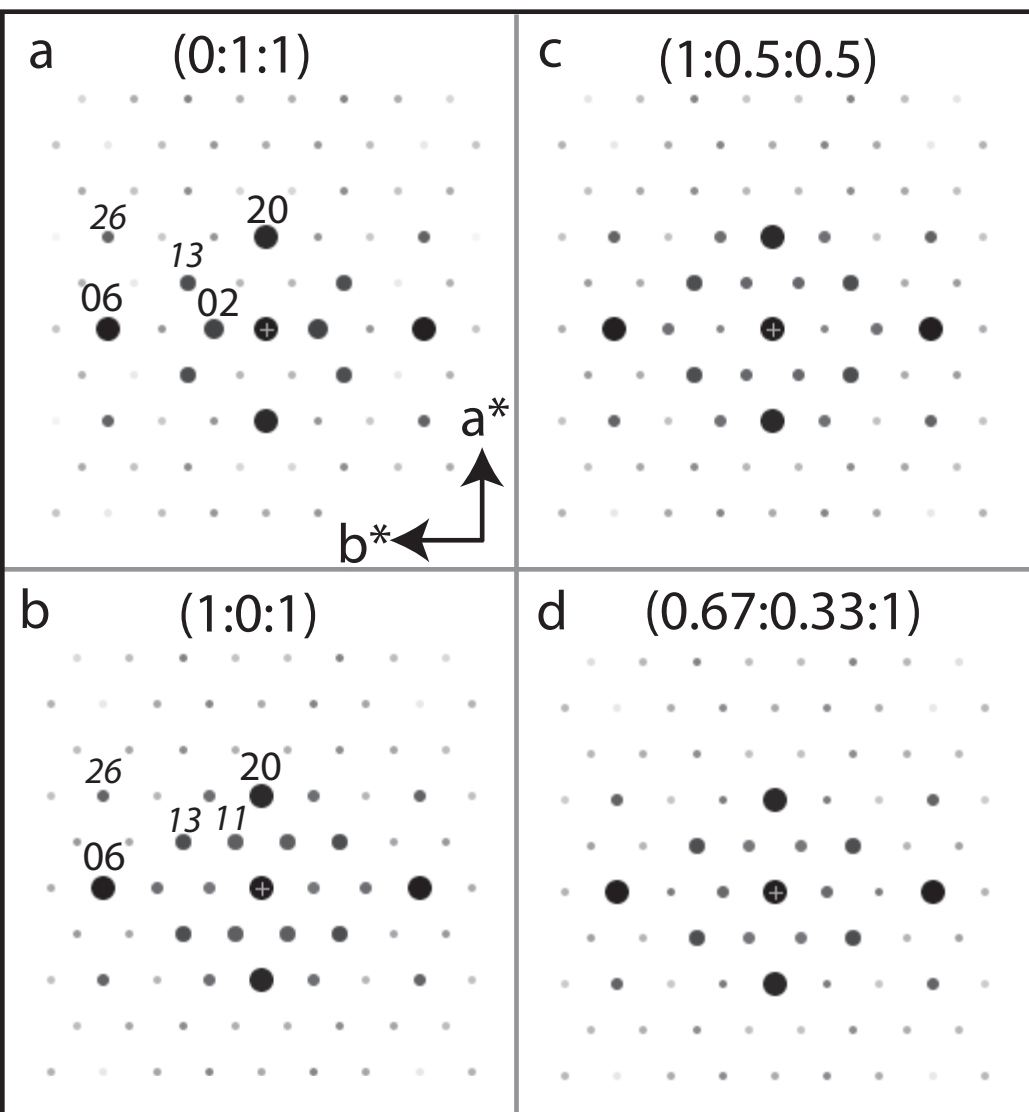

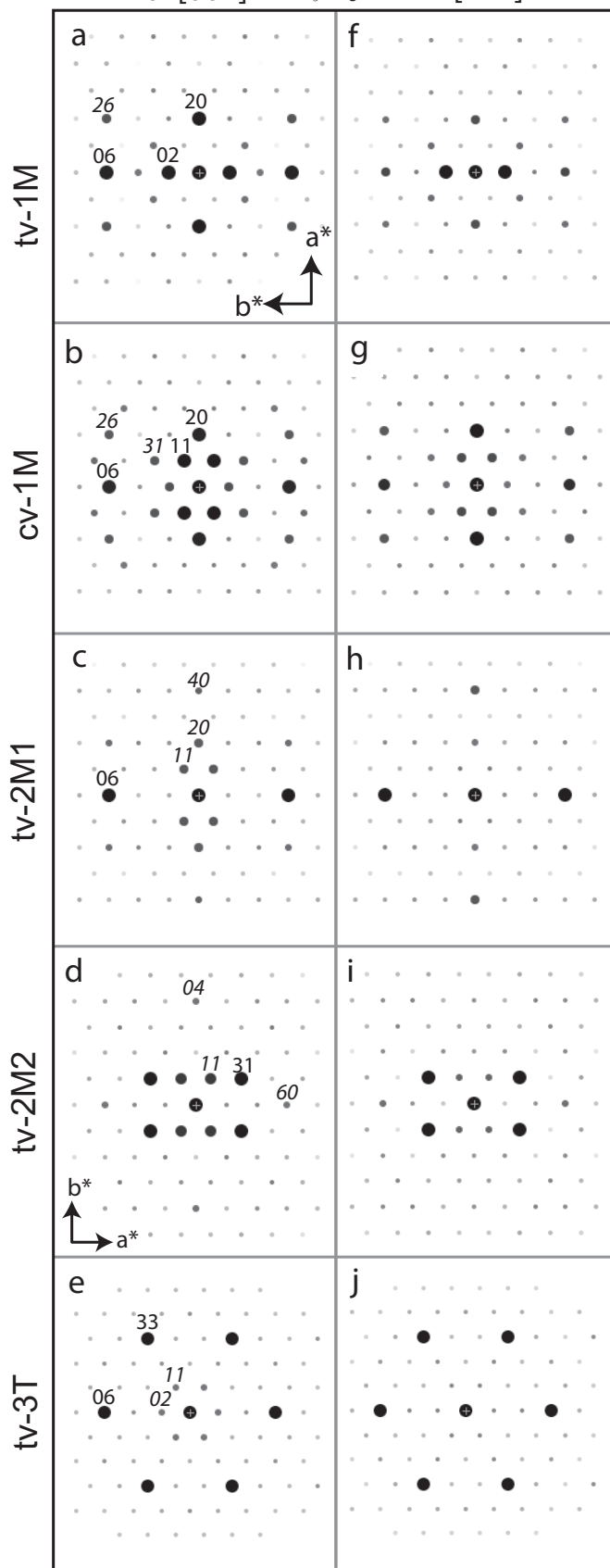

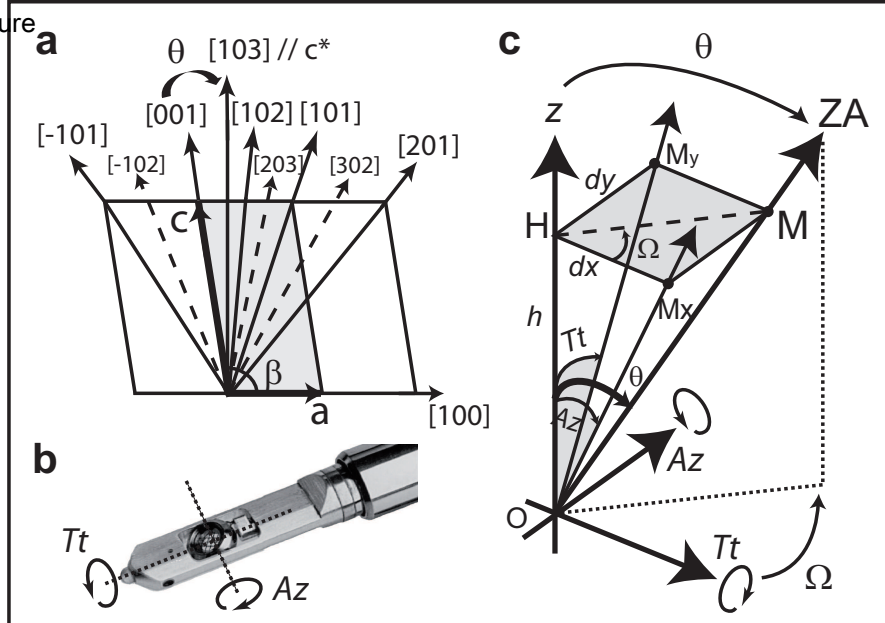

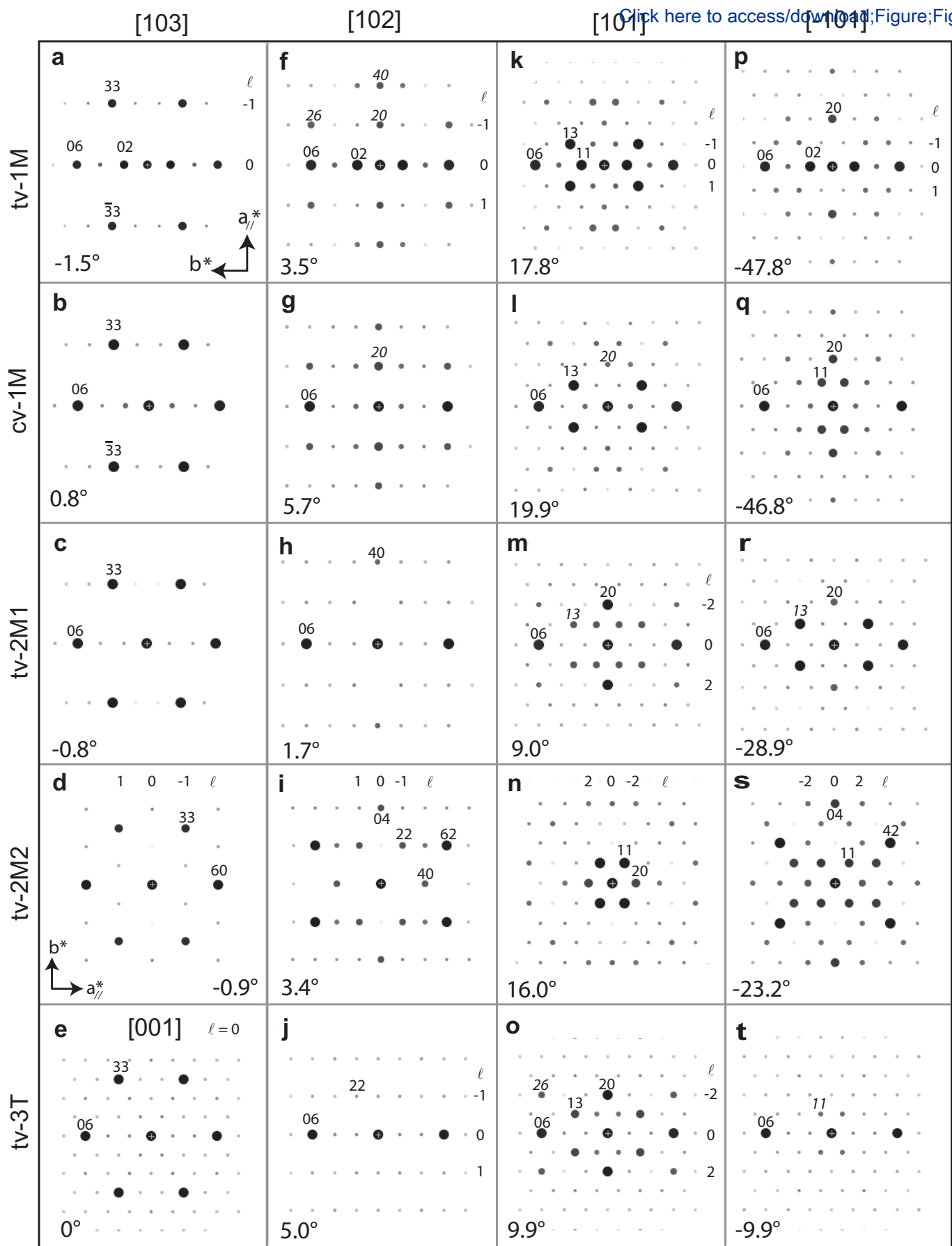

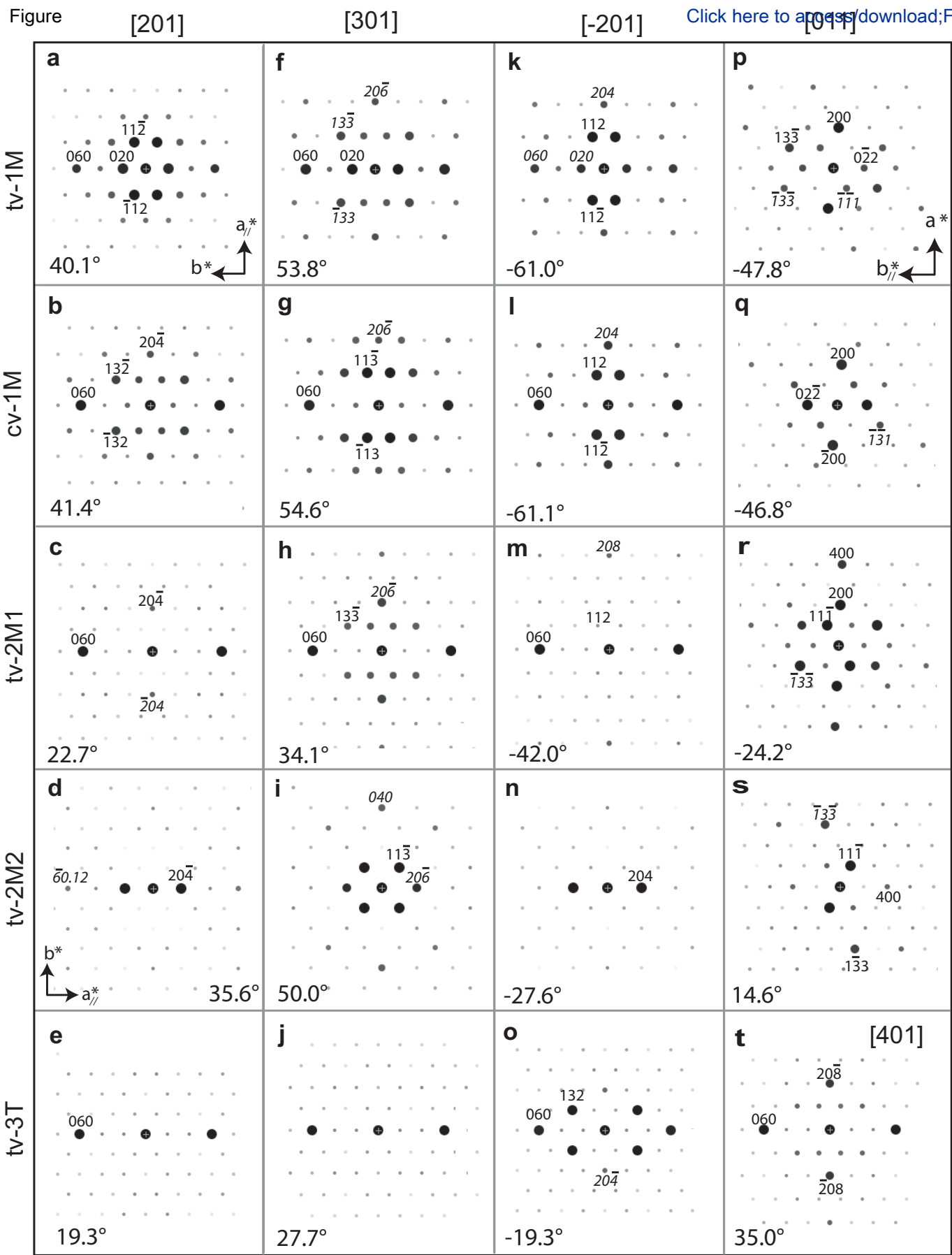

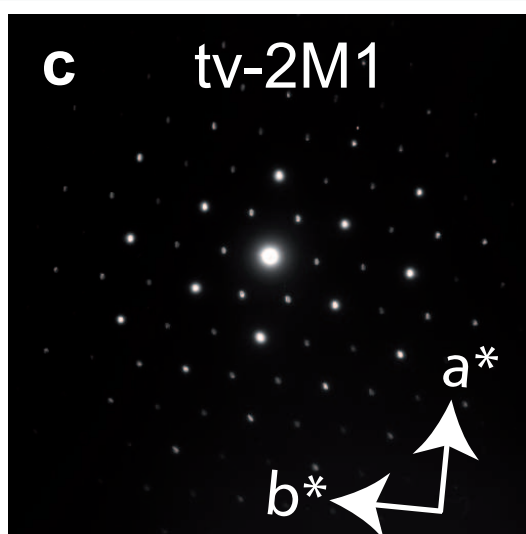
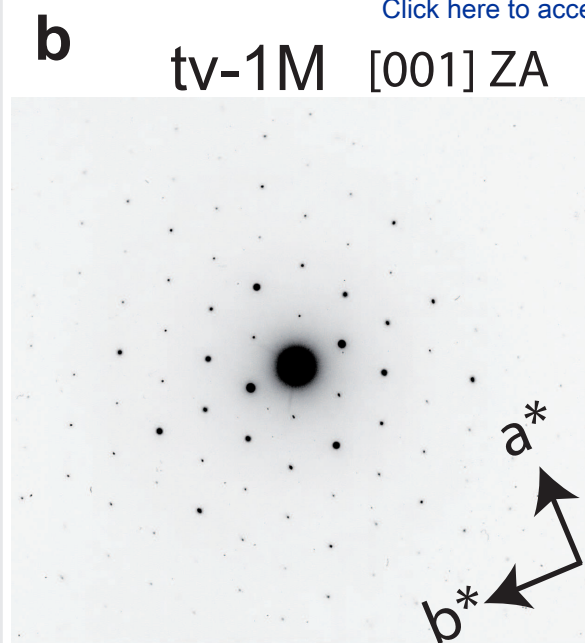

Tilt = -10.1° , Az = $+6.4^\circ$
 $|\theta|_{\text{exp}} = 11.9^\circ$

[101] ZA ; $\theta_{\text{th}} = -9.0^\circ$



Tilt = $+1.8^\circ$, Az = -5.6°
 $|\theta|_{\text{exp}} = 2.9^\circ$

[001] ZA ; $\theta_{\text{th}} = -5.8^\circ$