



HAL
open science

**A new species of *Prosyntexis* Sharkey 1990
(Hymenoptera: Sepulcidae) from Crato Formation
confirmed by geometric morphometric analysis**

Corentin Jouault, André Nel

► **To cite this version:**

Corentin Jouault, André Nel. A new species of *Prosyntexis* Sharkey 1990 (Hymenoptera: Sepulcidae) from Crato Formation confirmed by geometric morphometric analysis. *Palaeoentomology*, 2021, 4 (2), 10.11646/palaeoentomology.4.2.6 . insu-03206270

HAL Id: insu-03206270

<https://insu.hal.science/insu-03206270>

Submitted on 23 Apr 2021

HAL is a multi-disciplinary open access archive for the deposit and dissemination of scientific research documents, whether they are published or not. The documents may come from teaching and research institutions in France or abroad, or from public or private research centers.

L'archive ouverte pluridisciplinaire **HAL**, est destinée au dépôt et à la diffusion de documents scientifiques de niveau recherche, publiés ou non, émanant des établissements d'enseignement et de recherche français ou étrangers, des laboratoires publics ou privés.

A new species of *Prosyntexis* Sharkey 1990 (Hymenoptera: Sepulcidae) from Crato Formation confirmed by geometric morphometric analysis

CORENTIN JOUAULT^{1,2} & ANDRE NEL²

¹Univ. Rennes, CNRS, Geosciences Rennes, UMR 6118, F-35000, Rennes, France

²Institut de Systématique, Évolution, Biodiversité (ISYEB) Muséum national d'Histoire naturelle, CNRS, Sorbonne Université, EPHE, Université des Antilles, CP50, 57 rue Cuvier 75005 Paris, France

E-mail: jouaultc0@gmail.com, orcid.org/0000-0002-3680-5172

E-mails: anel@mnhn.fr, orcid.org/0000-0002-4241-7651

Abstract

Examination of new fossil specimens of *Prosyntexis* from the Lower Cretaceous Crato Formation of Brazil revealed a new species namely *Prosyntexis sennlaubi* sp. nov. To ensure the validity of the new taxon we examined previously described and figured specimens but we also figured an additional specimen of *Prosyntexis gouleti* Sharkey, 1990. The new species can be differentiated from the other *Prosyntexis* species of the Crato formation by its larger size but also in having the cell 2R1 small, the cell 2M small and short, the cell 3R1 narrow and the vein a directed toward wing apex. We performed a Geometric Morphometric Analysis (GMA) to estimate the variation in the forewing venation of the two species from the Crato Formation and ensure our placement.

Keywords: Symphyta, morphometry, Santana, Cretaceous, Aptian

Introduction

The Sepulcidae Rasnitsyn, 1968 is an important Mesozoic wasp family with several species ranging in age from the Jurassic (Rasnitsyn, 1968) to the Cretaceous (e.g., Rasnitsyn, 1993; Darling & Sharkey, 1990; Jattiot et al., 2011; Kopylov & Rasnitsyn, 2014, 2017a, b). The representatives of this fossil family are all described from fossil imprints, challenging observations of numerous key characters due to the incomplete state of preservation of the fossils (see, e.g., Rasnitsyn, 1993; Rasnitsyn & Ansoerge, 2000; Rasnitsyn & Martínez-Delclòs, 2000; Zhang et al., 2001).

Within the family, the Lower Cretaceous genus *Prosyntexis* Sharkey, 1990 comprises species described from Brazil (e.g., Jattiot et al., 2011), Mongolia (Rasnitsyn, 1993), Russian Federation (Rasnitsyn, 1993) and Spain (Rasnitsyn & Ansoerge, 2000). The type species *P. gouleti* Sharkey, 1990 was described from fossil imprints originating from the Crato Formation of Brazil (Darling & Sharkey, 1990). This fossil locality is known to be one of the largest fossil insect Lagerstätten and yields numerous symphytan specimens resulting in the description of numerous species (e.g., Jattiot et al., 2011; Freitas et al., 2020; Jouault et al., 2020). Recently, *Prosyntexis legitima* Martins-Neto et al. 2007 was described from the same outcrop but was later synonymized under *P. gouleti* (Jattiot et al., 2011). Using Geometric Morphometric Analysis we confirm this synonymization, explore the wing venation variations of *P. gouleti*, and show that the diversity of the genus *Prosyntexis* is underestimated in the Crato Formation.

Herein we describe a new species of *Prosyntexis* from the Crato Formation based on a well-preserved specimen. We combine our description to a Geometric Morphometric Analysis (GMA) to ensure our placement.

Material and methods

Origin and preparation of the material

The holotype of *Prosyntexis sennlaubi* sp. nov. derives from the Crato Formation, also called Crato Member of the Santana Formation. This deposit is composed of a limestone outcropping near Nova Olinda in the northeast Brazilian province of Ceará (7.2° S, 39.4° W: paleocoordinates 12.2° S, 10.8° W) (Barling et al., 2015: fig. 1; Ribeiro et al., 2021: fig. 1). The fossiliferous unit has been dated as late Aptian on the basis of its palynology (Pons et al., 1991; Varejão et al., 2021). The fossil is a partly compressed, three-dimensional mineralized replica. The cuticle was replaced by dark brown iron hydroxide (goethite); internally, the insect body is composed largely of calcite and apatite.

The holotype of *Prosyntexis sennlaubi* sp. nov. was prepared by removing the limestone matrix from around the body with fine blades and needles; the limestone dust was then removed with slight puffs of compressed air. Figures were composed with Adobe Illustrator CC 2019 and Photoshop CC 2019 software. We follow the wing venation of Jouault et al. (2020).

Geometric Morphometric Analyses (GMA)

GMA is often used in phenetic studies of relationships but rarely to explore the disparity and variations between species. Herein, we used seven forewings belonging to four specimen of *Prosyntexis* originating from the Crato Formation (Tab. 1). Based on the criterion for GMA that all specimens must have the same number of landmark points, we are limited by using only a reduced series of figured and non-figured specimens with well-preserved forewing venations. The original images were processed using ImageJ software (Schneider et al., 2012) for 16 landmarks of forewings of *Prosyntexis*, all landmarks representing key points on the wing veins (e.g., relative positions and shapes of the veins, branching points and/ or cells; Fig 1). The xy coordinates from wings were standardized using the ‘Procrustes’ function implemented in ImageJ. We generated a covariance matrix from the 16 landmarks and analysed the differences responsible for the variations

using a principal components analysis. The two principal component axes (PC) were the most informative representing nearly 80% of the variation (Fig. 2A, B). We exported the PC scores and analyzed them using the software PAST v4.05 (Hammer et al, 2001) performing a ‘multivariate analysis’ on the first two components using the parameter ‘Clustering’ and ‘classical’, with the unweighted pair-group method using the arithmetic averages (UPGMA) method and the similarity index set as ‘Euclidean’. The created tree shows the phenetic relationships among the studied specimens (Fig. 2C).

This published work and new nomenclatural acts are registered in ZooBank with the following LSID (reference): urn:lsid:zoobank.org:pub:C6C329DD-25A4-46A4-96BA-A02036B4D0BE

Systematic Palaeontology

Order Hymenoptera Linnaeus, 1758

Suborder Symphyta Gerstaecker, 1867

Superfamily Cephoidea Newman, 1835

Family Sepulcidae Rasnitsyn, 1968

Subfamily Trematothoracinae Rasnitsyn, 1988

Genus *Prosyntexis* Sharkey, 1990

Type species. *Prosyntexis gouleti* Sharkey, 1990 (late Aptian, Sierra do Araripe, Brazil).

Other species. *Prosyntexis gobiensis* (Rasnitsyn, 1993) (early Aptian, Bon Tsagaan, Mongolia), *Prosyntexis okhotensis* (Rasnitsyn, 1993) (early Aptian, Bon Tsagaan, Mongolia), *Prosyntexis montsecensis* Rasnitsyn & Ansoerge, 2000 (early Barremian, Montsec, Spain), *Prosyntexis sennlaubi* **sp. nov.** (late Aptian, Sierra do Araripe, Brazil).

***Prosyntexis gouleti* Sharkey, 1990**

Studied material. Specimen MNHN.F.A43720 (coll. Borschukewitz), deposited in the Laboratoire de Paléontologie, Muséum national d'Histoire naturelle, Paris, France; Specimen SMNS 66301 and specimen SMNS 66698a (imprint) – 66698b (counterimprint), deposited in the fossil collection of the State Museum of Natural History Stuttgart, Germany; Specimen 18022 from M. Sennlaub private collection (Figs 3, 6A).

***Prosyntexis sennlaubi* sp. nov.**

(Figs 4, 5, 6B)

urn:lsid:zoobank.org:act:2F40B159-B8A5-47E3-932F-417BEF8E5661

Holotype. Specimen identifier number 18.036 (a well-preserved 3-D fossil in ventral view), Markus Sennlaub will deposit it in the future in the Musée d'Histoire Naturelle et d'Ethnographie, Colmar, France.

Etymology. The specific epithet honors Markus Sennlaub who kindly allowed the specimen study.

Diagnosis. Large wasps; cell 2R1 small, about 1.78 times longer than wide; cell 2M small and short, 1.54 times longer than wide; cell 3R1 narrow, 3.57 times longer than wide.

Locality and age. Early Cretaceous, late Aptian or perhaps early Albian, Crato Formation, Brazil, Araripe Basin.

Description. Large wasp with a wing span ca. 27 mm and body length as preserved about 14.42 mm long and about 2.52 mm wide (measure at the level of wing insertion). Surface sculpture of body not apparent. No distinctive color pattern; as preserved, body black- to brown-colored; forewings somewhat infuscate, fully corrugate with pterostigma and vein Sc darker than surrounding veins.

Head rounded, nearly as long as wide (1.89 mm long, 1.95 mm wide with eyes included); eyes occupying most of head lateral surface, ca. 1.10 mm long; antenna inserted anteriorly on head with at least 10 preserved segments; vertex convex; ocelli not preserved.

Thorax (in ventral view) ca. 2.52 mm wide; tergite and sternite not discernible; fore and mid legs partially preserved and apparently slender; hind femora ca. 2.70 mm long, hind tibia ca. 2.95 mm long slightly widening towards apex; hind tarsus at least 2.24 mm long, tarsi not measurable.

Forewing ca. 12.30 mm long, ca. 4.30 mm wide (measure in apical third). Membrane covered with corrugations; both forewings almost complete with costa not perfectly preserved; costal space narrow, slightly enlarged medially (maybe due to preservation); C darkened, not fully visible; R straight; M+Cu and 1-A slightly curved basally; pterostigma broad and sclerotized; first abscissa of Rs (1-Rs) nearly straight, originating after Sc+R mid-length, 0.84 times as long as 1-M; 1-M shorter than Rs+M and 1-Cu veins; 1r-rs inclined and subequal to 1r-m, about twice as long as 2r-rs, cell 2R1 small; 2r-rs straight and directed towards wing apex; 3r-m straight, slightly inclined, and separated from 2r-rs by a length nearly equal to 1.7 of length of 3r-m, posteriorly located after 2M cell; 1m-cu vein nearly straight, shorter than 1-Rs and separating 1M and 2M cells; 1M cell rectangular with parallel sides; 1cu-a straight, located at base of cell 1M, nearly aligned to slightly postfurcal to 1M; 2M cell trapezoidal and elongate, 1.52 times longer than cell 1M, closed by a straight 2m-cu vein slightly inclined toward wing apex; 2m-cu situate in apical third of 1+2Rs cell, at a distance longer than its length from 1m-cu; 1Cu cell elongate, basally narrowing with M+Cu and 1-A veins approaching at base (maybe with a short vein stub emerging from 1-A in its distal part, only visible on right wing), separated from 2Cu cell by 1cu-a vein; 2Cu broadly triangular, elongate, tapering toward wing apex; 1A vein long, anal loop incomplete and not well-marked; 2+3A long, straight meeting 1A apically with a least one crossvein a; anal cells not visible (preservation incomplete or leg obscuring view). Hind wings partially preserved.

Abdomen incomplete with preserved part at least 8.20 mm long and 2.95 mm wide, slightly tapering toward apex, with at least eight segments.

Sex: female due to the presence of a medial carina on the last abdominal segments that received the ovipositor.

Remark. There is an important difference in the coloration of the forewing veins C and R between *P. gouleti* and *P. sennlaubi* sp. nov., viz. the former has both C and R dark while *P. sennlaubi* (Fig. 4) has C dark and R pale. But in the case of *P. gouleti*, the original colors are no longer present as the organic matter was replaced by iron oxide.

The forewing length of *Prosyntexis sennlaubi* sp. nov. is equal to 14.42 mm while the maximal length of the forewing of *Prosyntexis gouleti* is equal to 11.5 mm (average length near 9.66 mm measured on known specimens).

Discussion

The forewing venation of the fossil specimens described and figured above are nearly identical to those of the known representatives of the genus *Prosyntexis* (Fig. 6), currently included in the sepulcid subfamily Trematothoracinae. However, the body, the head and the antennae are poorly preserved in *Prosyntexis sennlaubi* sp. nov., a similar preservation is recorded in numerous specimens of *P. gouleti* including the one shown here.

Sharkey (in Darling & Sharkey, 1990) proposed the following diagnosis for the genus *Prosyntexis*: 2r-m crossvein of forewing absent; 2R1 cell of forewing wider basally than apically; 1Rs+M of forewing reaching 1m-cu crossvein; 3R1 cell closed; 1M cell long and four-sided; cu-a crossvein only slightly postfurcal (Fig. 6). All these character states are found in our new species supporting its attribution to the genus *Prosyntexis*. However, the character 'Rs+M of forewing reaching 1m-cu crossvein' is not recorded in our specimen of *P. gouleti* since 1Rs+M forks slightly

basal of 1m-cu. This state was also mentioned and similar in another specimen of *P. gouleti*, ensuring our placement (see Jattiot et al., 2011: figs 1– 10).

Prosyntexis sennlaubi sp. nov. differs from *P. gouleti* in having longer and broader forewings (ca. 12.30 mm long vs. 9.66 mm long on average in *P. gouleti*); smaller cell 2R1; thinner cell 3R1; shorter 2M cell and 1A cell closed basally by vein a directed toward wing apex (vs. directed toward wing base). Additionally, the wing venation analysis under GMA indicates that *Prosyntexis sennlaubi* sp. nov. occupies a morphospace separate from *P. gouleti*.

Prosyntexis sennlaubi sp. nov. differs from *Prosyntexis gobiensis* (Rasnitsyn, 1993) in having the veins 3r-m and 2m-cu not aligned and the cell 2R1 longer than wide (Rasnitsyn, 1993: fig. 28). It differs from *Prosyntexis okhotensis* (Rasnitsyn, 1993) in having a more elongate cell 1+2Rs and a cell 1M longer than wide (Rasnitsyn, 1993: fig. 27). The forewing venation of *Prosyntexis montsecensis* Rasnitsyn and Ansoerge, 2000 is very incompletely preserved; nevertheless its cell 3R1 is narrower than in *Prosyntexis sennlaubi* sp. nov., compared to its length (Rasnitsyn & Ansoerge, 2000: fig. 1b).

Conclusion

The species of the genus *Prosyntexis* differ in few characters, mainly in the proportions and shapes of the forewing cells and veins. Nevertheless, we could demonstrate that the use of the phenetic Geometric Morphometric Analysis tools can be efficient to detect a new, ‘cryptic’ species among these wasps. It is remarkable that so similar species were present in very distant places during the Barremian to Aptian of Mongolia, Spain, and Brazil. During all the Early Cretaceous, South America was still connected to Africa but separated from Spain (an island close to Europe) by the Tethys Ocean, while Mongolia, in Eastern Asia, was more or less connected to North America by a ‘Beringian’ bridge, while North and South America were separated (Scotese, 2014a, b). It is only during the Latest Jurassic (around 145.5 Ma) that all these regions was better connected, allowing

faunal exchanges, suggesting a Latest Jurassic origin and a remarkable morphological stability during ca. 30 Ma for the genus *Prosynthexis*.

Acknowledgements

We thank a lot Prof. A.P. Rasnitsyn, an anonymous referee, and Dr. Neal Evenhuis for their useful remarks on the first version of the paper. We particularly thank Mr. Markus Sennlaub who allowed us to study the holotype specimen.

References

- Barling, N., Martill, D.M., Heads, S.W. & Gallien, F. (2015) High fidelity preservation of fossil insects from the Crato Formation (Lower Cretaceous) of Brazil. *Cretaceous Research*, 52, 605–622. <https://doi.org/10.1016/j.cretres.2014.05.007>
- Darling, D.C. & Sharkey, M.J. (1990) Hymenoptera. pp. 123–153. *In*: Grimaldi, D.A. (Ed.). Insects from the Santana formation, Lower Cretaceous, of Brazil. *Bulletin of the American Museum of Natural History*, 195, 1–191. <http://hdl.handle.net/2246/943>
- Freitas, L.C.B., Rasnitsyn, A.P., Moura, G.J.B. & Mendes, M. (2020) New species of *Myrmicium* Westwood (Pseudosiricidae = Myrmiciidae: Hymenoptera, Insecta) from the Early Cretaceous (Aptian) of the Araripe Basin, Brazil. *Anais da Academia Brasileira de Ciências*, 92, e20200479. <https://doi.org/10.1590/0001-3765202020200479>
- Gerstaecker, C.E.A. (1867) Über die Gattung *Oxybelus* Latr. und die bei Berlin vorkommenden Arten derselben. *Zeitschrift für die Gesamten Naturwissenschaft*, 30, 1–96.
- Jattiot, R., Krogmann, L. & Nel, A. (2011) Revision of *Prosynthexis* from the Lower Cretaceous Crato Formation of Brazil (Hymenoptera: Sepulcidae: Trematothoracinae). *Zootaxa*, 3058, 55–62. <https://doi.org/10.11646/zootaxa.3058.1.4>

- Jouault, C., Pouillon, J-M. & Nel, A. (2020) The first fossil horntail wasp (Hymenoptera: Siricidae) from Lower Cretaceous Crato Formation in Brazil. *Palaeoentomology*, 3, 382–389. <https://doi.org/10.11646/palaeoentomology.3.4.10>
- Kopylov, D.S. & Rasnitsyn, A.P. (2014) New Trematothoracinae (Hymenoptera: Sepulcidae) from the Lower Cretaceous of Transbaikalia. *Proceedings of the Russian Entomological Society*, 85, 199–206.
- Kopylov, D.S. & Rasnitsyn, A.P. (2017a) New sepulcids (Hymenoptera: Sepulcidae) from the Lower Cretaceous of Asia. I. Parapamphiliinae and Xyelulinae. *Paleontological Journal*, 51, 69–76. <https://doi.org/10.1134/S0031030117010087>
- Kopylov, D.S. & Rasnitsyn, A.P. (2017b) New sepulcids (Hymenoptera: Sepulcidae) from the Lower Cretaceous of Asia. II. Ghilarellinae and Trematothoracinae. *Paleontological Journal*, 51, 291–303. <https://doi.org/10.1134/S0031030117030029>
- Hammer, Ø., Harper, D.A.T. & Ryan, P.D. (2001) PAST: Paleontological statistics software package for education and data analysis. *Palaeontologia Electronica*, 4, 9. http://palaeo-electronica.org/2001_1/past/issue1_01.htm
- Linnaeus, C. von (1758) *Systema Naturae per regna tria naturae secundum classes, ordines, genera, species cum characteribus, differentiis, synonymis, locis*. Ed. decima reformata. Holmiae, Laur. Salvii, 1, 1–823.
- Martins-Neto, R.G., Melo, A.C. & Prezoto, F. (2007) A new species of wasp (Symphyta, Sepulcidae) from the Santana Formation (Lower Cretaceous, Northeast Brazil). *Journal of the Entomological Research Society*, 9, 1–6.
- Newman, E. 1835. *The grammar of entomology*, London, Frederick Westley and A.H. Davis (Publ.), i–xvi + 1–304.
- Pons, D., Berthou, P.-Y. & Campos, D.A. (1991) Quelques observations sur la palynologie de l’Aptien supérieur et de l’Albien du bassin d’Araripe (N.E. du Brésil). *In*: Campos, D.A., Vianna,

- M.S.S., Brito, P.M. & Beurlen, G. (Eds), Atas do I simposio sobre a Bacia do Araripe e Bacias Interiores do Nordeste, Crato, pp. 241–252.
- Rasnitsyn, A.P. (1968) Noviye Mezozoyskiye Pilil'shchiki (Hymenoptera, Symphata) [New Mesozoic sawflies (Hymenoptera, Symphata)]. Yurskie Nasekomiye Karatau [Jurassic Insects of Karatau] 190–236.
- Rasnitsyn, A.P. (1988) Sepul'ki i proiskhozhdenie steblevykh pilil'shchikov (Hymenoptera: Cephidae, Sepulcidae). *Trudy Vsesoiuznogo Entomologicheskogo Obshchestva*, 70, 68–73.
- Rasnitsyn, A.P. (1993) Novye taksony sepulek (Vespida: Sepulcidae) [New taxa of Sepulcidae (Mesozoic Vespida from Asia).] pp. 80–99. In: Ponomarenko, A.G. (ed.). Mezozoyskie Nasekomye i Ostrakody Azii. *Trudy Paleontologicheskogo Instituta Akademii nauk SSSR*, 252, 1–160. (in Russian)
- Rasnitsyn, A.P. & Ansorge, J. (2000) New Early Cretaceous hymenopterous insects (Insecta: Hymenoptera) from Sierra del Montsec (Spain). *Palaeontologische Zeitschrift*, 74, 335–341. <https://doi.org/10.1007/BF02988105>
- Rasnitsyn, A.P. & Martínez-Delclòs, X. (2000) Wasps (Insecta: Vespida = Hymenoptera) from the Early Cretaceous of Spain. *Acta Geologica Hispanica*, 35, 65–95.
- Ribeiro A.C., Ribeiro, G.C., Varejão, F.G., Battirola, L.D., Pessoa, E.M., Simões, M.G., Warren, L.V., Riccomini, C. & Poyato-Ariza, F.C. (2021) Towards an actualistic view of the Crato Konservat-Lagerstätte paleoenvironment: A new hypothesis as an Early Cretaceous (Aptian) equatorial and semi-arid wetland. *Earth-Science Reviews*, 216, 103573. <https://doi.org/10.1016/j.earscirev.2021.103573>.
- Schneider, C.A., Rasband, W.S. & Eliceiri, K.W. (2012) NIH Image to ImageJ: 25 years of image analysis. *Nature Methods*, 9, 671675. <https://doi.org/10.1038/nmeth.2089>

Scotese, C.R. (2014a) Atlas of Early Cretaceous Paleogeographic Maps, PALEOMAP Atlas for ArcGIS, volume 2, The Cretaceous, Maps 23–31, Mollweide Projection, PALEOMAP Project, Evanston, IL.

Scotese, C.R. (2014b) Atlas of Jurassic Paleogeographic Maps, PALEOMAP Atlas for ArcGIS, volume 4, The Jurassic and Triassic, Maps 32-42, Mollweide Projection, PALEOMAP Project, Evanston, IL.

Varejão, F.G., Warren, L.V., Simões, M.G., Buatois, L.A., Mángano, M.G., Bahniuk, A.M.R. & Assine, M.L. (2021) Mixed siliciclastic-carbonate sedimentation in an evolving epicontinental sea: Aptian record of marginal marine settings in the interior basins of north-eastern Brazil. *Sedimentology*, (online) <https://doi.org/10.1111/sed.12846>

Zhang, H.-C., Zhang, J-F. & Wei, D.-T. (2001) Discovery of Trematothoracinae (Insecta) in the Upper Jurassic of W. Liaoning, China with a discussion of its phylogeny. *Acta Palaeontologica Sinica*, 40, 224–228.

FIGURE 1. *Prosyntexis sennlaubi* sp. nov., holotype 18.036, forewing with landmarks used in GMA analysis. Scale bar = 2 mm.

FIGURE 2. Results of the GMA analysis. **A**, Percentage of variance related to the principal component. **B**, Graph showing principal components 1 and 2. **C**, Tree showing phenetic relationships among studied specimens and obtained using UPGMA analysis.

FIGURE 3. *Prosyntexis gouleti* Sharkey, 1990 Specimen 18.022. **A**, Photograph. **B**, Interpretative line drawing of wing venation (hind wing veins in red). Scale bars = 2 mm.

FIGURE 4. *Prosyntexis sennlaubi* sp. nov. holotype 18.036, photograph of habitus. Scale bar = 2mm.

FIGURE 5. Interpretative line drawing of wing venation (hind wing veins in red). Scale bar = 2 mm.

FIGURE 6. Interpretative line drawing of forewing of *Prosyntexis* spp. from Crato formation. **A**, *P. gouleti* Sharkey, 1990, specimen 18022. **B**, *Prosyntexis sennlaubi* **sp. nov.**, holotype 18.036. Scale bars = 2 mm.

Table 1. Material used in the GMA analysis.

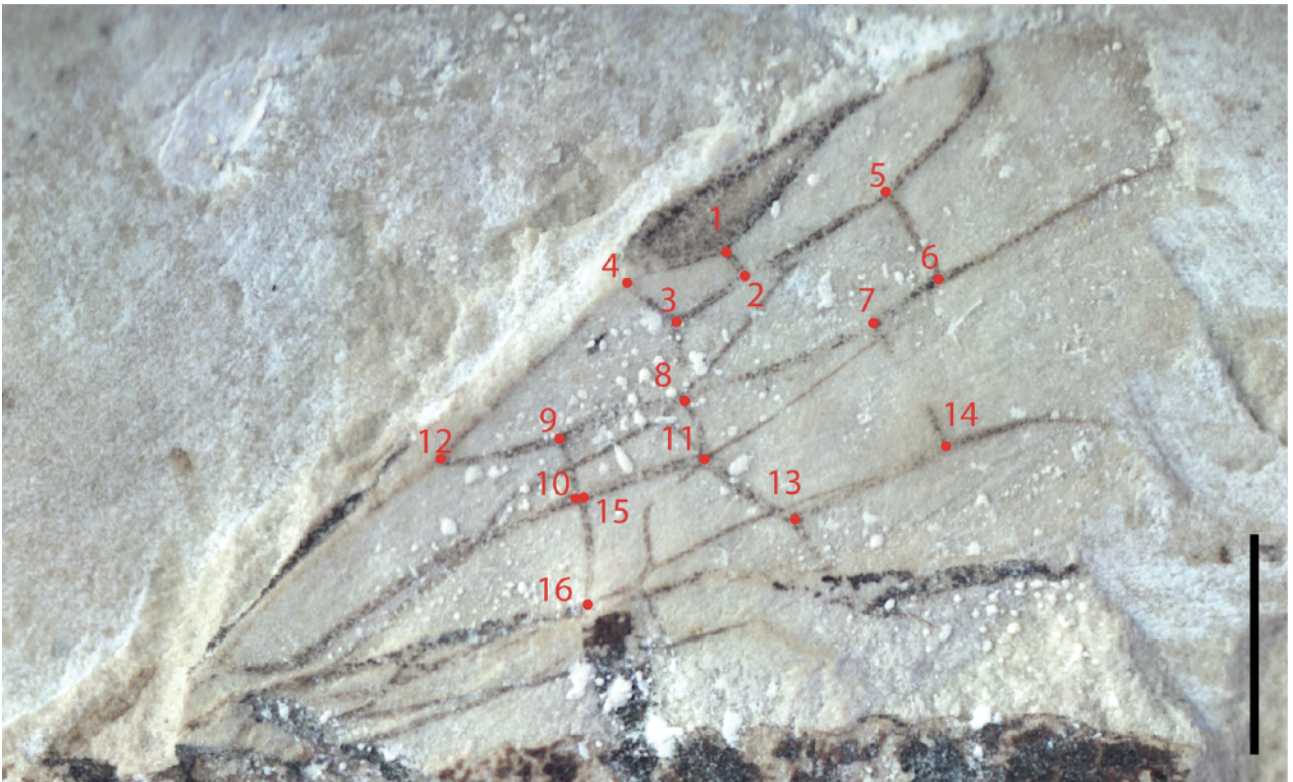

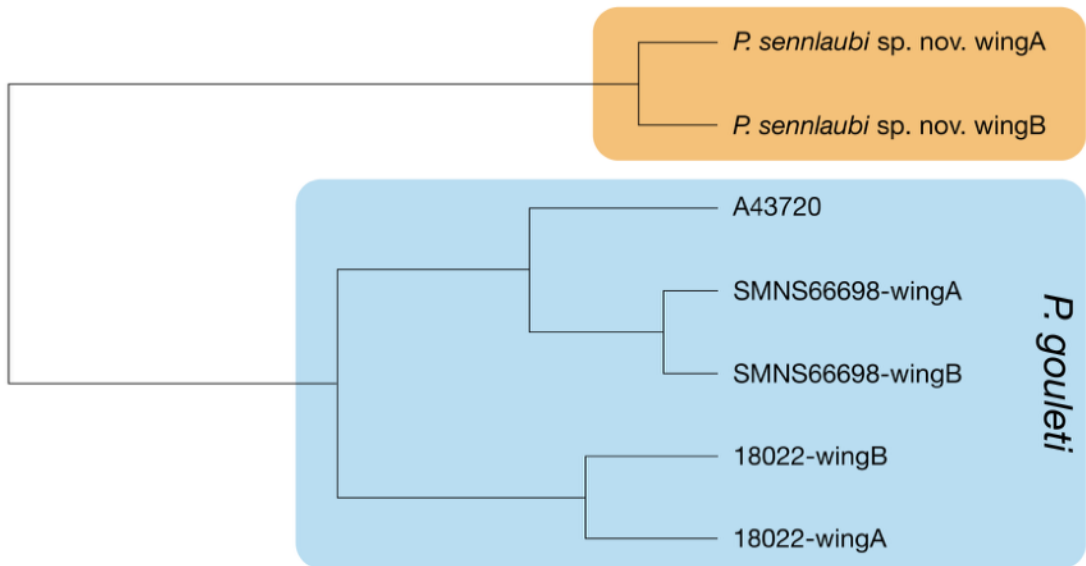
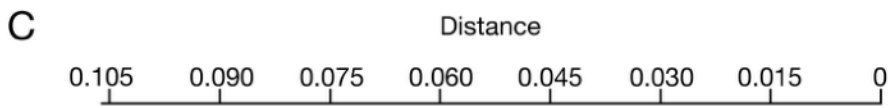
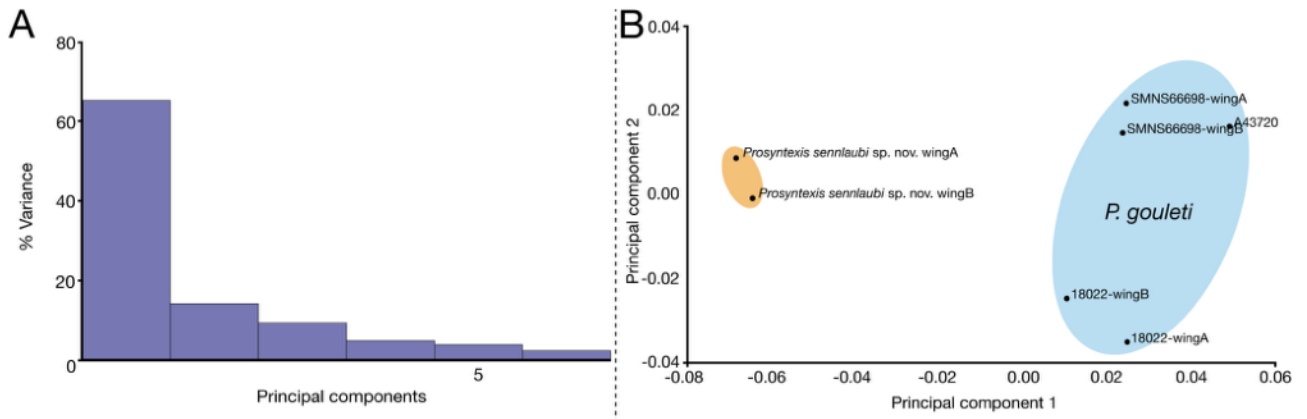

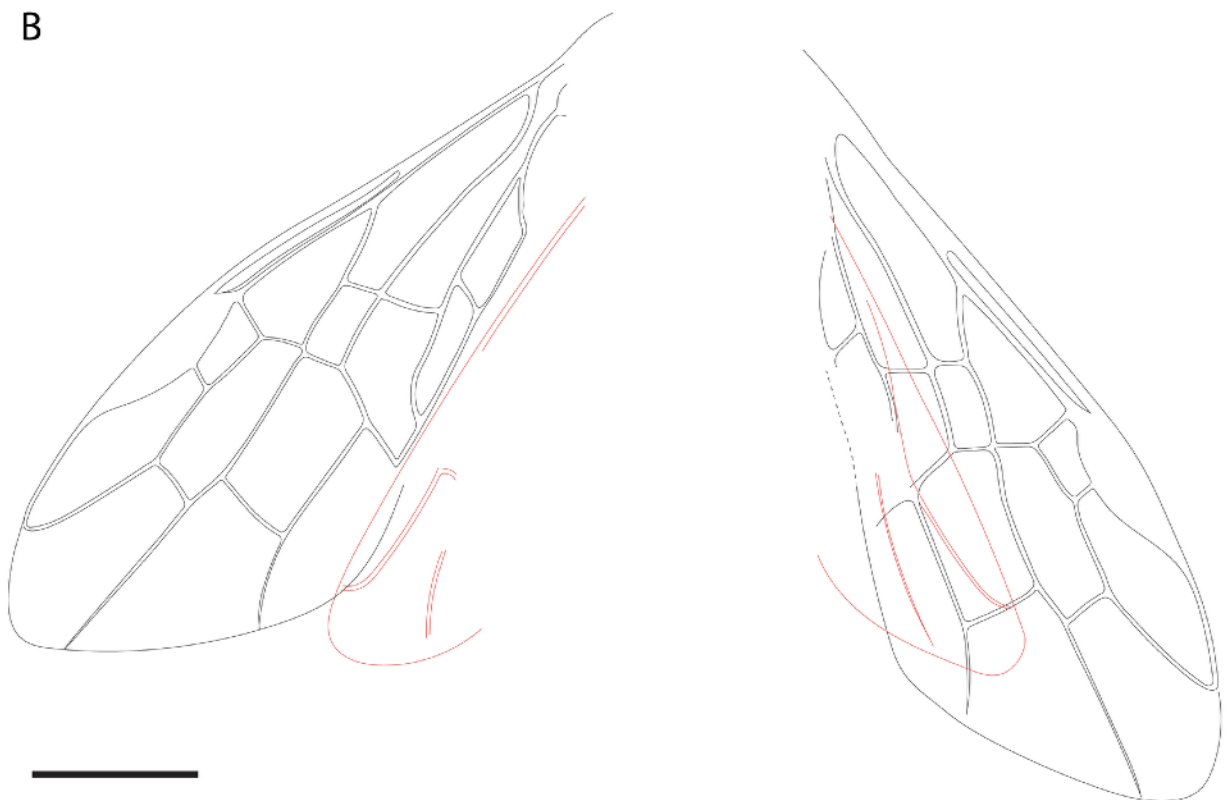

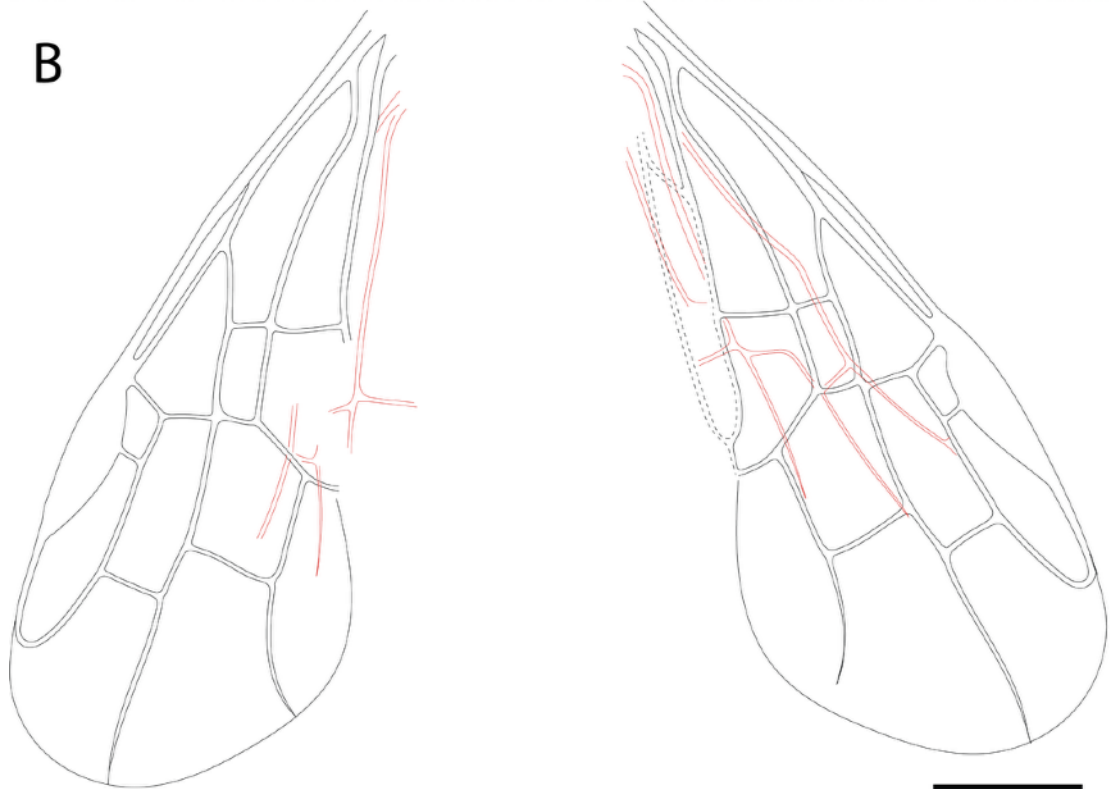
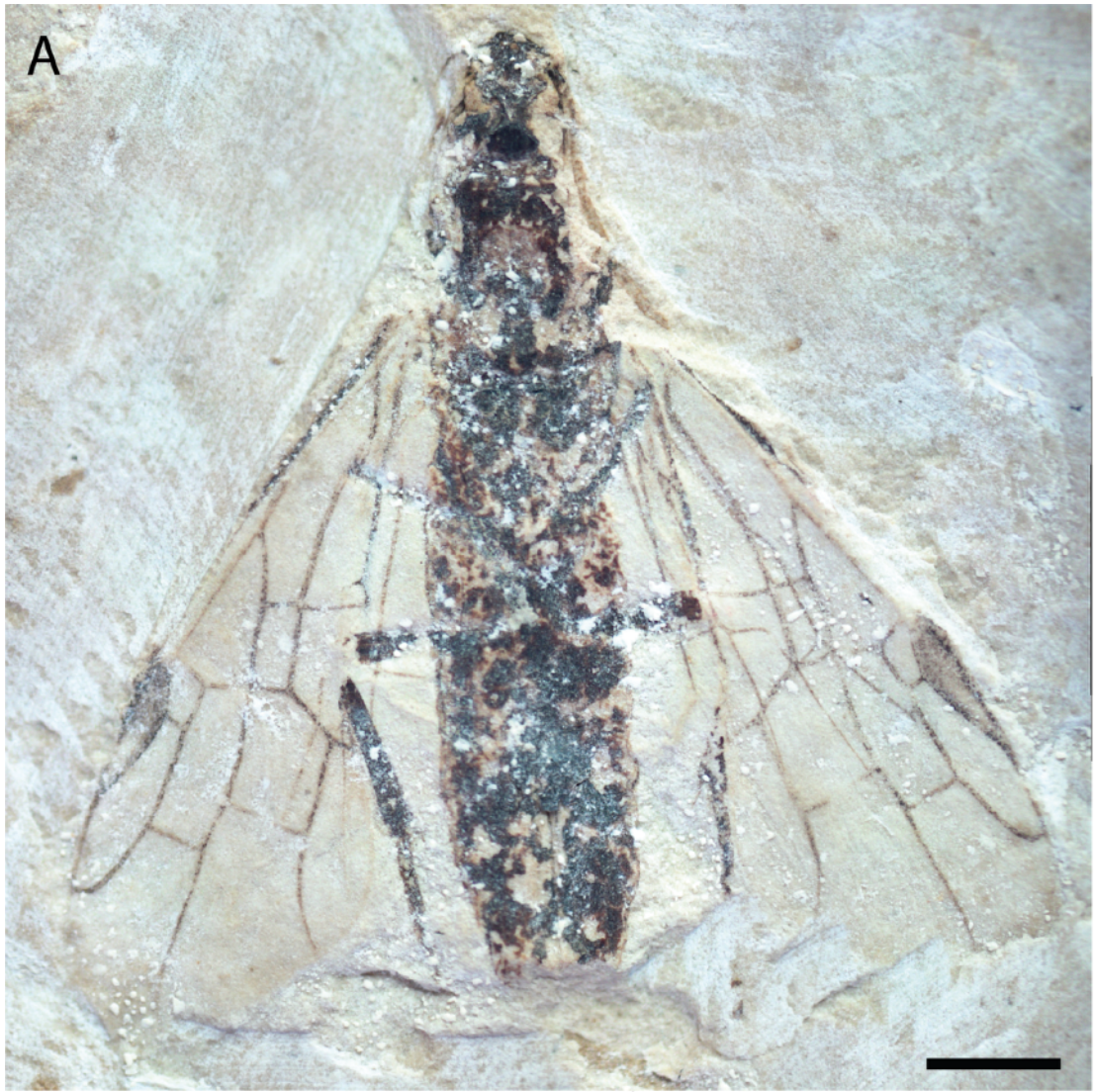

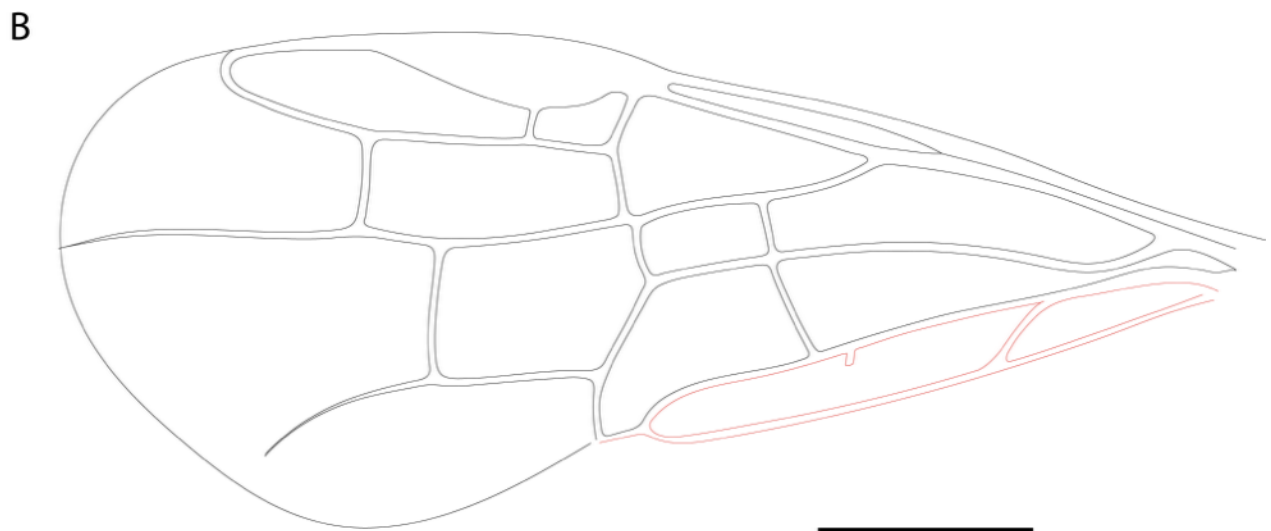
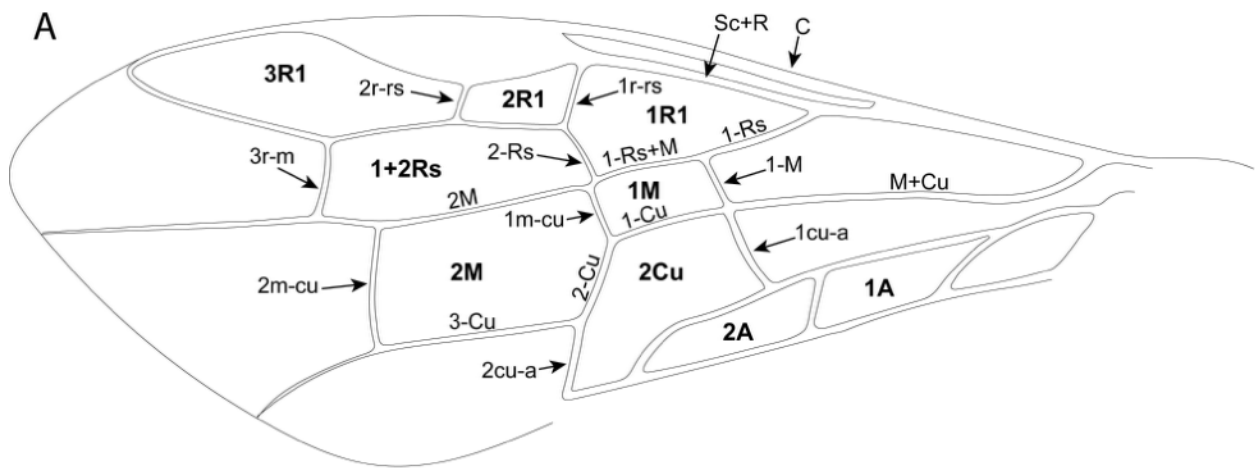

Species	Specimen number	Reference
<i>P. gouleti</i> (wing A)	18.022	This study
<i>P. gouleti</i> (wing B)	18.022	This study
<i>P. gouleti</i>	A43720	Jattiot et al., 2011
<i>P. gouleti</i> (wing A)	SMNS66697	Jattiot et al., 2011
<i>P. gouleti</i> (wing B)	SMNS66698	Jattiot et al., 2011
<i>Prosyntexis sennlaubi</i> sp. nov. (wing A)	18.036	This study
<i>Prosyntexis sennlaubi</i> sp. nov. (wing B)	18.036	This study