



HAL
open science

Parasitic hump-backed flies (Diptera: Phoridae) from Middle Miocene ambers

Mónica M Solórzano-Kraemer, Clément Bourdeau, Simon Rosse-Guillevic, Jörg U Hammel, Chunpeng Xu, Brian V Brown

► **To cite this version:**

Mónica M Solórzano-Kraemer, Clément Bourdeau, Simon Rosse-Guillevic, Jörg U Hammel, Chunpeng Xu, et al.. Parasitic hump-backed flies (Diptera: Phoridae) from Middle Miocene ambers. *Palaeoworld*, 2024, 32 (4), pp.669-685. 10.1016/j.palwor.2021.11.002 . insu-03431983

HAL Id: insu-03431983

<https://insu.hal.science/insu-03431983>

Submitted on 17 Nov 2021

HAL is a multi-disciplinary open access archive for the deposit and dissemination of scientific research documents, whether they are published or not. The documents may come from teaching and research institutions in France or abroad, or from public or private research centers.

L'archive ouverte pluridisciplinaire **HAL**, est destinée au dépôt et à la diffusion de documents scientifiques de niveau recherche, publiés ou non, émanant des établissements d'enseignement et de recherche français ou étrangers, des laboratoires publics ou privés.

Journal Pre-proofs

Parasitic hump-backed flies (Diptera: Phoridae) from Middle Miocene ambers

Mónica M. Solórzano-Kraemer, Clément Bourdeau, Simon Rosse-Guillevic,
Jörg U. Hammel, Chunpeng Xu, Brian V. Brown

PII: S1871-174X(21)00091-3
DOI: <https://doi.org/10.1016/j.palwor.2021.11.002>
Reference: PALWOR 658

To appear in: *Palaeoworld*

Received Date: 6 July 2021
Revised Date: 28 September 2021
Accepted Date: 3 November 2021

Please cite this article as: M.M. Solórzano-Kraemer, C. Bourdeau, S. Rosse-Guillevic, J.U. Hammel, C. Xu, B.V. Brown, Parasitic hump-backed flies (Diptera: Phoridae) from Middle Miocene ambers, *Palaeoworld* (2021), doi: <https://doi.org/10.1016/j.palwor.2021.11.002>

This is a PDF file of an article that has undergone enhancements after acceptance, such as the addition of a cover page and metadata, and formatting for readability, but it is not yet the definitive version of record. This version will undergo additional copyediting, typesetting and review before it is published in its final form, but we are providing this version to give early visibility of the article. Please note that, during the production process, errors may be discovered which could affect the content, and all legal disclaimers that apply to the journal pertain.

© 2021 Elsevier B.V. and Nanjing Institute of Geology and Palaeontology, CAS.

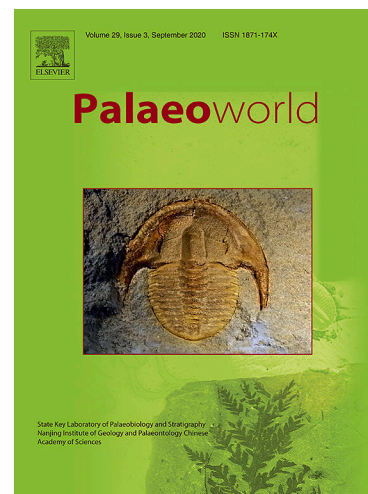

Parasitic hump-backed flies (Diptera: Phoridae) from Middle Miocene ambers

Mónica M. Solórzano-Kraemer¹, Clément Bourdeau², Simon Rosse-Guillevic³, Jörg U. Hammel⁴, Chunpeng Xu^{5,6} & Brian V. Brown⁷

¹Senckenberg Research Institute, D-60325 Frankfurt am Main, Germany

²Laboratoire des Bio-Indicateurs Actuels et Fossiles (BIAF) UPRES EA 2644, Université d'Angers, 2, Boulevard Lavoisier, F-49045 Angers Cedex, France

³Univ Rennes, CNRS, Géosciences Rennes, UMR 6118, F-35000 Rennes, France

⁴Institute of Materials Physics, Helmholtz-Zentrum Hereon, Max-Planck-Straße 1, D-21502, Geesthacht, Germany

⁵State Key Laboratory of Palaeobiology and Stratigraphy, Nanjing Institute of Geology and Palaeontology and Center for Excellence in Life and Paleoenvironment, Chinese Academy of Sciences, Nanjing 210008, China

⁶University of Chinese Academy of Sciences, Beijing 100049, China

⁷Entomology Section, Natural History Museum of Los Angeles County, 900 Exposition Boulevard, Los Angeles, CA 90007, USA

Abstract: Phorid flies are an abundant and diverse dipteran family in modern faunas, yet poorly represented in the fossil record. Here, we describe the first fossil species of the millipede parasitizing genus *Myriophora*, *M. asiatica* n. sp., and three new fossil species of the ant parasitizing genus *Apocephalus*, *A. miocenus* n. sp., *A. dominicanus* n. sp., and *A. chiapanecus* n. sp. discovered in Miocene amber deposits from China, Dominican Republic, and Mexico. Moreover, we add details on the previously described species *Apocephalus succineus* Brown, previously described in Dominican amber, with the description of a new specimen. We also include a dichotomous key for all *Apocephalus* species described in the fossil record.

Abstract: Phorid flies are an abundant and diverse dipteran family in modern faunas, yet poorly represented in the fossil record. Here, we describe the first fossil species of the millipede parasitizing genus *Myriophora*, *M. asiatica* n. sp., and three new fossil species of the ant parasitizing genus *Apocephalus*, *A. miocenus* n. sp., *A. dominicanus* n. sp., and *A. chiapanecus* n. sp. discovered in Miocene amber deposits from China, Dominican Republic, and Mexico. Moreover, we add details on the previously described species *Apocephalus succineus* Brown, previously described in Dominican amber, with the description of a new specimen. We also include a dichotomous key for all *Apocephalus* species described in the fossil record.

Parasitic hump-backed flies (Diptera: Phoridae) from Middle Miocene ambers

Mónica M. Solórzano-Kraemer¹, Clément Bourdeau², Simon Rosse-Guillevic³, Jörg U. Hammel⁴, Chunpeng Xu^{5,6} & Brian V. Brown⁷

¹Senckenberg Research Institute, D-60325 Frankfurt am Main, Germany

²Laboratoire des Bio-Indicateurs Actuels et Fossiles (BIAF) UPRES EA 2644, Université d'Angers, 2, Boulevard Lavoisier, F-49045 Angers Cedex, France

³Univ Rennes, CNRS, Géosciences Rennes, UMR 6118, F-35000 Rennes, France

⁴Institute of Materials Physics, Helmholtz-Zentrum Hereon, Max-Planck-Straße 1, D-21502, Geesthacht, Germany

⁵State Key Laboratory of Palaeobiology and Stratigraphy, Nanjing Institute of Geology and Palaeontology and Center for Excellence in Life and Palaeoenvironment, Chinese Academy of Sciences, Nanjing 210008, China

⁶University of Chinese Academy of Sciences, Beijing 100049, China

⁷Entomology Section, Natural History Museum of Los Angeles County, 900 Exposition Boulevard, Los Angeles, CA 90007, USA

Parasitic hump-backed flies (Diptera: Phoridae) from Middle Miocene ambers

Mónica M. Solórzano-Kraemer ^{a *}, Clément Bourdeau ^b, Simon Rosse-Guillevic ^c, Jörg U. Hammel ^d, Chun-Peng Xu ^{e, f}, Brian V. Brown ^g

^a Senckenberg Research Institute and Natural History Museum, Senckenberganlage 25, D-60325, Frankfurt am Main, Germany

^b Laboratoire des Bio-Indicateurs Actuels et Fossiles (BIAF) UPRES EA 2644, Université d'Angers, 2, Boulevard Lavoisier, F-49045 Angers Cedex, France

^c Univ Rennes, CNRS, Géosciences Rennes, UMR 6118, F-35000 Rennes, France

^d Institute of Materials Physics, Helmholtz-Zentrum Hereon, Max-Planck-Straße 1, D-21502 Geesthacht, Germany

^e State Key Laboratory of Palaeobiology and Stratigraphy, Nanjing Institute of Geology and Palaeontology and Center for Excellence in Life and Palaeoenvironment, Chinese Academy of Sciences, Nanjing 210008, China

^f University of Chinese Academy of Sciences, Beijing 100049, China

^g Entomology Section, Natural History Museum of Los Angeles County, 900 Exposition Boulevard, Los Angeles, CA 90007, USA

* Corresponding author. *E-mail address*: monica.solorzano-kraemer@senckenberg.de

Abstract

Phorid flies are an abundant and diverse dipteran family in modern faunas, yet poorly represented in the fossil record. Here, we describe the first fossil species of the millipede

parasitizing genus *Myriophora*, *M. asiatica* n. sp., and three new fossil species of the ant parasitizing genus *Apocephalus*, *A. miocenens* n. sp., *A. dominicanus* n. sp., and *A. chiapanecus* n. sp. discovered in Miocene amber deposits from China, Dominican Republic, and Mexico, respectively. Moreover, we add details on the species *Apocephalus succineus* Brown, previously described in Dominican amber, with the observation of a new specimen. We also include a dichotomous key for all *Apocephalus* species described in the fossil record.

Keywords: Phoridae; Miocene; Amber; Zhangpu; Mexico; Dominican Republic

1. Introduction

The family Phoridae contains more than 4400 described species within about 250 genera (www.phorid.net/pcat/ visited in April 2021), probably representing only a small fraction of its true diversity (Gaston, 1991; Heraty, 2009; Srivathsan et al., 2019). They are a cosmopolitan group and are among the most diversified families of Diptera in terms of morphology, dietary resources, and hosts (Disney, 1994). The group comprises tiny flies from 0.4 mm to 6 mm, characterized by a humped thorax that gave them the nickname of “Humpbacked flies”. Some of them also have the habit of fleeing by running instead of flying. This behavior gave them the other nickname of “scuttle flies”.

The most ancient fossils of the family belong to the genus *Prioriphora* McAlpine and Martin, 1966, and are found in the Cedar Lake amber in Canada (Brown and Pike, 1990), the Albian amber deposits of Archingeay in France (Perrichot, 2004; Solórzano Kraemer et al., 2011), and from the lower Cretaceous amber deposits of Álava in Spain (Arillo and Mostovski, 1999). They are also found in Paleogene compression deposits, but they are mostly found in fossil resin deposits (Evenhuis, 1994; Brown, 1999) being one of the most abundant insects in fossil and Recent resins (Solórzano Kraemer et al., 2018).

Among the numerous described species, at least 611 are parasitoids. Parasitoid species are found mostly in four genera: *Pseudacteon* Coquillett, 1907, *Melaloncha* Brues, 1904, *Apocephalus* Coquillett, 1901, and *Myriophora* Brown, 1992. The specimens described in this work belong to the last two.

The genus *Apocephalus* contains 343 described species classified in subgenera and species groups, based principally on abdominal and ovipositor characters (Brown, 2012, 2014; Brown et al., 2018a). They are found in both the Nearctic and Neotropical regions in the New World (Disney, 1994; Brown et al., 2018a, 2018b). The genus is also known by the nickname “Ant-decapitating flies” because many species are parasitoids of ants, within which

the larva develops and eventually makes the head of the host fall off (Brown et al., 2018a). However, *Apocephalus* species also parasitize stingless bees, carpenter bees, cantharoid beetles, and honey bees (Brown, 1996a, 1996b; Core et al., 2012). The fossil record is limited to the Miocene Dominican amber. It is only represented by the species *A. succineus* Brown, 2000, which belongs to the *A. miricauda* species group (Brown, 2000) and several non-described specimens found also in the Dominican amber (Brown, 1992, 2000).

A. succineus was described together with living *Apocephalus* of the *miricauda*-group. However, the diversity within the genus during the Miocene appears to be higher than expected. In order to differentiate the previously described *A. succineus* from new species, we add here a more detailed description, pictures, and drawings that can help future works.

Many *Myriophora* species were previously described in the genus *Plastophora* Brues, 1905 (Hash and Brown, 2015). The type-species of the genus *Plastophora* was *P. beirne* Brues, 1905; however, the holotype was lost during the Hungarian revolution (Borgmeier, 1963). The genus diagnosis has also been greatly widened since 1905 and the genus was eventually synonymized with *Megaselia* Rondani, 1856 (Disney, 1978). Then, Brown (1992) defined the genus *Myriophora* using *P. aequaliseta* Borgmeier, 1963 as the type-species and included some other species formerly classified in *Plastophora* in the newly created genus. The genus is cosmopolitan and contains 65 described species (Hash and Brown, 2015) and an estimated diversity of about 200 extant species (Hash et al., 2018). Extant species of *Myriophora* are parasitoids of polydesmidan and juliform millipedes (Hash et al., 2018). In the fossil record, the genus has only been reported in the Early Miocene Dominican amber (Brown, 1999). Thus, the specimen described here is the first report from the Miocene of another locality. No older specimen has been found until today (Hash et al., 2018).

2. Geological setting

The specimen of *Myriophora* described here comes from the Zhangpu amber deposits of the Fotan group in the Fujian Province, China, dated from Middle Miocene to Late Miocene (Zheng et al., 2019) and reconstructed as a megathermal seasonal rainforest (Wang et al., 2021). No radiological dating has been performed yet on rocks of the Fotan group, but the studies of Ho et al. (2003) on basalts from nearby localities showed an age of 14.8 ± 0.6 Ma. Later, Wang et al. (2021) confirmed an age between 14.8 ± 0.6 Ma and 14.7 ± 0.4 Ma. The study of the terpenoids composition in Zhangpu amber showed that the resin must have been produced by trees from the family Dipterocarpaceae Blume, 1825. These results were

supported by the co-occurring fruits belonging to this family (Shi et al., 2014a, 2014b; Jacques et al., 2015).

Four specimens of *Apocephalus* are also described, three of them found in amber from the Dominican Republic, which is located in the eastern Greater Antilles archipelago, in the Hispaniola Island. These deposits date from the Early Miocene to the early Middle Miocene (~16 Ma) and are principally found in La Toca and Yanigua formations (Iturralde-Vinent and McPhee, 1996). The resin-producing tree is a Fabaceae Lindley, 1836 described under the species name *Hymenaea protera* Poinar, 1991. The fourth specimen is included in Mexican amber from La Quinta Formation, Simojovel, Chiapas. The age of Mexican amber has been argued similar to Dominican amber (Solórzano Kraemer, 2007). However, Perrilliat et al. (2010) and Serrano-Sánchez et al. (2015) argued an age of 22.8 Ma for La Quinta Formation based on the biostratigraphy of corals, molluscs, microfossils, and strontium. Both ambers come from similar environments. The amber-producing tree species of the Mexican amber also belongs to the genus *Hymenaea* Linnæus, 1753, with *H. mexicana* Poinar and Brown, 2002 and *H. allendis* Calvillo-Canadell et al., 2010.

3. Material and methods

The described specimens comprise three phorids contained in pieces of amber coming from La Toca Formation in Dominican Republic. Collection numbers Do-369-K and Do-1059-K, and one phorid in Mexican amber from Simojovel, Chiapas with the collection number Mx-443 are housed at the amber collection of the Stuttgart State Museum of Natural History (SMNS). The Dominican amber piece MNHNSD FOS 17.02 was donated by Jorge Caridad to the Museo Nacional de Historia Natural “Prof. Eugenio de Jesús Marcano”, Santo Domingo (MNHNSD), Dominican Republic. One phorid contained in amber is from the Fotan group in Zhangpu County, Fujian Province, under the collection number NIGP177329. This piece is housed at Nanjing Institute of Geology and Palaeontology, Chinese Academy of Sciences (NIGPAS).

All the amber pieces have been prepared (cut and polished) in order to get the best view of each inclusion. The Zhangpu amber piece NIGP177329 has been embedded in clear resin to avoid the stickiness of the amber that could have troubled the observations by catching dusts and debris, which would have required re-polishing.

The specimens were observed under a stereomicroscope Leica MZ12 with cold light, and the drawings were produced using a camera lucida (Leica 1446193) and the software Adobe Illustrator. The photographs and Z-stacks images were performed under a Nikon SMZ25

microscope, using Nikon SHR Plan Apo 0.5x and SHR Plan Apo 2x objectives with a microscope camera Nikon DS-Ri2 and the NIS-Element software.

Specimen MNHNSD FOS 17.02 was analysed using synchrotron-radiation based X-ray microtomography (SR μ CT). The imaging was performed at the Imaging Beamline – IBL P05 – PETRA III at Deutsches Elektronen Synchrotron (DESY) in Hamburg, Germany operated by the Helmholtz-Zentrum Hereon (Greving et al., 2014; Wilde et al., 2016), with a photon energy of 18 keV, and a sample to detector distance of 0.3 m. X-ray projections were recorded using a custom developed 20 MP CMOS camera system (Lytaev et al., 2014) with an effective pixel size of 0.64 μ m. Three thousand six hundred one equally spaced projections between 0 and π were recorded for a tomographic scan. Tomographic reconstruction has been done by applying a transport of intensity phase retrieval approach and using the filtered back projection algorithm (FBP) implemented in a custom reconstruction pipeline (Moosmann et al., 2014) using Matlab (Math-Works) and the Astra Toolbox (Palenstijn et al., 2011; van Aarle et al., 2015, 2016). For the processing raw projections were binned for further processing two times resulting in an effective pixel size of the reconstructed volume of 1.28 μ m. The specimens were segmented in three dimensions using region-growing techniques in VGStudioMax (Volume Graphics, Heidelberg, Germany).

Morphological nomenclature follows the Manual of Central American Diptera (Brown et al., 2010), Brown and Kung (2007, 2010), and Cumming and Wood (2017).

4. Systematic palaeontology

Order Diptera Linnæus, 1758

Family Phoridae Curtis, 1833

Genus *Myriophora* Brown, 1992

Type species: *Myriophora aequaliseta* (Borgmeier, 1963).

The following species described here belongs to the genus *Myriophora* based on the following characters in the single female specimen, following Brown (1992) and Hash and Brown (2015):

Frons with 4-4-4 arrangement of setae; wings present; vein R₂₊₃ present. Segment 7 with extremely elongate tergite and sternite, downturned at tip; sternite 8 elongated; elongate ovipositor markedly shaped and compressed; oviscape with strongly sclerotized sternite and

tergite; oviscape membrane longitudinally striated; cerci large, pointed ventrally, cercal setae significantly reduced.

Myriophora asiatica Solórzano-Kraemer, Bourdeau and Brown, n. sp.

(Figs. 1, 2)

LSID: urn:lsid:zoobank.org:act:E7BDE3FE-6F7A-44D3-A2D7-BEEFAF20F825.

Etymology: The specific epithet *asiatica* refers to the ancient origin in the Asian continent.

Holotype: NIGP177329, housed in the collection of the NIGPAS, adult female in Zhangpu amber, without syninclusions.

Diagnosis (female): Anepisternum bare, lateral margin of tergite 2 without large setae, short anterior scutellar setae, long tubular oviscape with large cercus and tubular hypoproct bearing long thin setae on its apex.

Description:

Female. (Fig. 1A, B). Head: setae in 4-4-4 pattern (Fig. 2G); broad frons with 2 pairs of supra-antennal setae; lower supra-antennal setae less than 1/2 the length of upper pair; supra-antennal setae proclinate and almost parallel (Figs. 1C, D, 2G); 1 pair of post-ocellar setae, 1 pair of outer vertical setae; ~25–30 ommatidia aligned in eye maximum length; flagellomere rounded; sensilla of flagellomeres uniformly distributed; 5 strong setae on palpus. Thorax: anepimeron-katepisternum suture roughly linear; anepisternum bare; posterior anepisternal crest wide; 3 pairs of notopleural setae; 1 pair of supra-alar setae; 1 pair of post-alar setae; 2 pairs of setae on the scutellum; anterior scutellar setae less than 1/2 the length of posterior pair (Fig. 1E, F); base of halter close to the wing base; halter large. Wings: 2 strong setae on the basicosta; 3 strong setae on the tegula (Fig. 2B); costal vein less than half of the wing length; costa with short, thick, spine-like setae; costa extends to R_{4+5} ; R_1 reaches proximal third of the wing; R_{2+3} present (Fig. 2A, H); vein M_1 attached to $R_{2+3} - R_{4+5}$ junction; vein A_1 seem to reach distal part of wing. Legs: midtibia bare; hind coxa with scattered setae on ventral half; hind coxa with 2 setae on lateral part; hind femur with 5 strong setae on proximal half of posterior face; hind tibia with 1 setae palisade; hind tibia with 1 spur on distal end; hind tarsomere 2 with 1 spur on distal end. Abdomen: no seta on lateral margin of tergite 2 (Figs. 1E, 2C); membrane of segments of terminalia with longitudinal striation; dorsal surface of tergite 3 without dots; lateral margin of segments 3–5 bare; lateral face of segments 5–6 membranous; posterior margin of tergite 5 flat and bare; tergite 6 entire without setae. Genitalia: oviscape elongated and tube-like (Fig. 2D–F); sclerites of oviscape greatly fused;

membrane of ov scape with parallel longitudinal striation; cercus covered with short setae; hypoproct elongated and bearing long thin setae on distal end (Fig. 2F).

Male unknown.

Measurements: Body length (head to end of terminalia) 2.2 mm. Head: length (dorsoventrally) 0.31 mm, width 0.42 mm. Scutum: length 0.34 mm, width 0.36 mm. Wing: length 1.25 mm, costal length 0.44 mm, costal index 0.35, costal sector ratio 8:2:1. Oviscape: length 0.58 mm.

Remarks: Following the species key provided by Hash and Brown (2015), *M. asiatica* n. sp. can be differentiated from other species with similar morphology. There are no setae on lateral margin of tergite 2, like *M. alienipennis* Hash and Brown, 2015 and *M. pectinata* Hash and Brown, 2015. However, *M. asiatica* n. sp. differs from *M. alienipennis* by having a significantly longer terminalia compared to the body length. *M. asiatica* n. sp. also differs from *M. pectinata* by having a bare anepisternum and lacking strong, long setae on the posterior margin of tergite 6. According to the key to the New World female *Myriophora* published in Hash and Brown (2015), *M. asiatica* n. sp. is anatomically close to the extant species *M. sinesplendida* Hash and Brown, 2015. However, the two species differ from each other by several characters. *M. sinesplendida* bears strong setae on the lateral margin of tergite 2, absent in *M. asiatica* n. sp.; its terminalia are smaller compared to the body length, contrary to *M. asiatica* n. sp.; and the end of its ov scape is thinner than in the species described here.

Occurrence: Langhian; Fotan group, Zhangpu County, Fujian Province, China. The ages of basalt samples underlying and overlying the fossil layers are 14.8 ± 0.6 Ma and 14.7 ± 0.4 Ma, respectively (Wang et al., 2021).

Genus *Apocephalus* Coquillett, 1901

Type species: *A. pergandei* Coquillett, 1901.

All the following species belong to the genus *Apocephalus* based on the following characters mentioned by Brown (1993, 1994, 1996a): Lower interfrontal setae divergent or parallel, close to midline. Notopleural cleft absent. Anepisternum divided, without setae. Distinctive ovipositor present; anterior margin of ovipositor usually with dark periphery in dorsal view; species with a uniformly darker ovipositor lack middle and lower frontal orbital setae. Segments posterior to segment 7 withdrawn inside segment 7 at rest in female.

The various species groups of *Apocephalus* are being revised by Brown (summarized by Brown, 2012, 2014; Brown et al., 2018a).

Apocephalus miocenus Solórzano-Kraemer, Bourdeau and Brown, n. sp.

(Fig. 3)

LSID: urn:lsid:zoobank.org:act:0B52913F-4FED-4F97-9FD7-F28933B71104.

Etymology: the specific epithet *miocenus* refers to the geological epoch in which the amber piece originated.

Holotype: Do-369-K, housed in the collection of the SMNS, adult female included in Dominican amber, 4 syninclusions (3 Chalcidoidea Latreille, 1817, 1 Thysanoptera Haliday, 1836).

Diagnosis (female): One pair of supra-antennal setae, narrower oviscape that flaring out in a rounded lobe posteriorly.

Description:

Female. (Fig. 3A). Head: frontal setae in 4-4-4 pattern; 1 pair of proclinate supra-antennal setae; fronto orbital and ventral interfrontal setae divergent; dorsal interfrontal reclinate (Fig. 3B, F); ~18–20 ommatidia aligned in eye maximum length; first flagellomere roughly rounded; sensilla of 1st flagellomere uniformly distributed. Thorax: suture dividing anepimeron and katapisternum roughly linear; surface of anepisternum bare; anterodorsal extension of anepimeron flat; 1 postpronotal setae; 1 strong notopleural setae; 1 long, strong supra-alar setae; scutellum with 2 pairs of setae; median scutellar setae less than 1/2 length of lateral scutellar setae. Wings (Fig. 3C, G): 2 strong setae on the distal margin of the tegula; costal vein not inflated; costal setae short, thick and spine-like; costa extends to R₄₊₅; Sc not visible; R₁ reaching most proximal third of the wing; R₂₊₃ present; R₄₊₅ not connected to costal vein and ending before the distal third of the wing length; M₁ appearing to be attached to R₄₊₅; M₂ roughly linear; A₁ not visible (Fig. 3G). Legs: hind coxa with scattered setae on the ventral half; distal portion of anterior face of hind femur with a distinct brown patch. Abdomen: dorsal surface of tergite 3 without spot; posteroventral margins of abdominal segments bare, with striation; no seta visible on lateral margin of the tergites; abdominal segment 6 elongated (Fig. 3D). Genitalia: oviscape elongated and dorsoventrally curved, strongly sclerotized; with posteriorly pointed anterior section, darkened lateral margin, and rounded posterior lobe.

Male unknown.

Measurements: Body length 2.6 mm. Head: length 0.38 mm, width 0.52 mm. Scutum: length 0.44 mm, width 0.40 mm. Wing: length 1.66 mm, width 0.7 mm, costal length 0.8 mm, costal index 0.46, costal ratio 5.5:2:1. Oviscape: length 0.28 mm.

Remarks: *Apocephalus miocenus* n. sp. differs from *A. succineus* by having only one pair of supra-antennal setae, and a narrower oviscape that flares out in a rounded lobe posteriorly. Based on the shape of the oviscape, it belongs to the *A. miricauda* group (revised by Brown, 2000) but to a different subgroup than that to which *A. succineus* belongs. Based on the shape of the oviscape, it is especially similar to *A. annulatus* Brown, 2000, which belong to an unknown subgroup (Brown, 2000).

Occurrence: Burdigalian–Langhian; La Toca Formation, Dominican Republic. The age is considered 20 Ma to 15 Ma (Iturralde-Vinent and MacPhee, 1996, 2019; Iturralde-Vinent, 2001).

Apocephalus succineus Brown, 2000

(Figs. 4, 5)

Type: Holotype LACM-IP 12785, female, included in Dominican amber from Santiago/Puerto Plata area. The holotype is deposited in The Natural History Museum of Los Angeles County's Invertebrate Paleontology collection (LACMIP) (Brown, 2000, pp. 17–18). Do-1059-K is presented here as an additional specimen to *Apocephalus succineus* Brown, 2000, adult female included in Dominican amber (Fig. 4A, B), two syninclusions (1 Lepidoptera Linnaeus, 1758, 1 Formicidae Latreille, 1809).

The assignment to the species is based on the following characters mentioned by Brown (2000): Two pairs of supra-antennal setae (Figs. 4C, E, 5D); palpus regular and small; anterior scutellar setae enlarged, longer than 1/2 posterior setae; mean costal length 0.44 to 0.45 wing length (Figs. 4D, 5C); abdomen without dense lateral setae; ovipositor broad.

Additional description to Brown (2000): With a new, well preserved, female exemplar (Do-1059-K) of the species *A. succineus* (holotype LACMIP) we add the following characters to the original description by Brown (2000). Head: broad frons; anterior supra-antennal setae close to posterior supra-antennal setae; 1 pair of post-ocellar setae; ~25–30 ommatidia aligned in eye maximum length; first flagellomere rounded; 4 strong setae on the palpus (Fig. 5D). Thorax: 1 pair of strong, long anterior post-pronotal setae; 1 pair of strong, long notopleural setae; 1 pair of strong, long supra-alar setae; 1 pair of strong, long post-alar setae; 2 strong anterior tegular setae; posterior part of the tegula with a row of strong setae. Wing: 3 strong

alular setae. Legs: hind tibia with one setal palisade. Abdomen: 3 pairs of setae on lateral margin of tergite 2; venter of segment 6 with long, scattered setae absence of long, scattered setae on the venter of the lateral margin of tergite 5. Genitalia: ovipositor dorsoventrally flat; sclerites clearly visible (Fig. 5A, B).

Measurements: Body length 2.8 mm. Head: length 0.36 mm, width 0.55 mm. Scutum: length 0.5 mm, width 0.55 mm. Wing: length 1.4 mm, costal length 0.57 mm, costal index 0.4, costal ratio 5:3:1. Oviscape: length 0.6 mm.

Remarks: The specimen from Do-1059-K does not have long, scattered setae on the venter of the lateral margin of tergite 5, contrary to the holotype of *A. succineus*. However, this could only be a variation within the species. Do-1059-K contains an unidentified Formicidae belonging to the subfamily Formicinae Latreille, 1809; however not in the same layer of resin as the *A. succineus*. Thus, it can not a priori be considered as a host for the phorid. Moreover, *A. miricauda* Borgmeier, 1971 group members, which *A. succineus* belongs to, are parasitoids of injured ants from the subfamily Ponerinae Lepeletier de Saint-Fargeau, 1835. Therefore, inferring a host-parasite relationship would be speculative. Also, 3 Chalcidoidea have been found in the piece of amber Do-369-K and may be interesting for further studies, as well as the Formicidae.

Occurrence: Burdigalian–Langhian; La Toca Formation, Dominican Republic. The age is considered 20 Ma to 15 Ma (Iturralde-Vinent and MacPhee, 1996, 2019; Iturralde-Vinent, 2001).

Apocephalus dominicanus Solórzano-Kraemer, Rosse-Guillevic and Brown, n. sp.
(Figs. 6, 7)

LSID: urn:lsid:zoobank.org:act:23827544-EAAF-4AB0-9992-C8D447EF5DAC.

Etymology: The specific epithet *dominicanus* refers to the origin of the amber piece in the Dominican Republic.

Holotype: MNHNSD FOS 17.02, housed in the collection of the MNHNSD, adult female included in Dominican amber, 4 syninclusions (1 Pseudomyrmecinae Smith, 1952, genus *Pseudomyrmex* Lund, 1831 – worker; 2 Myrmicinae Lepeletier de Saint-Fargeau, 1835, genus *Carebara* Westwood, 1840 – both males; 1 Araneae Clerck, 1757).

Diagnosis (female): Strong and invaginated abdominal constriction after segment 6, parasitic-type terminalia, segment 7 (oviscape) tubular, broadening posteriorly and folding above

ovipositor, pulvillus bearing long tenent hairs with sole like spatulate tips visible on mid- and hind leg.

Description:

Female. (Figs. 6A, 7A, B, D, E). Head: frons broad, interorbital distance subequal to total face length (Fig. 6B, G); 4-4-4 frontal setae pattern, reclinate; ventral interfrontal setae slightly convergent, situated midway between eye margin and midline; 1 pair of supra-antennal setae, proclinate; ~20–21 ommatidia aligned in eye maximum length; all ommatidia subequal in size and shape; flagellomere 1 globular; arista thin, longer than flagellomere 1; proboscis short. Thorax: anepisternal furrow present (proepimeron greatly expanded); anepisternum bare; 1 strong seta on postpronotum; 1 seta on paratergite; 2 long setae on ventral side of proepisternum; 2 pairs of strong scutal setae; scutellum with 2 pairs of setae, subequal in size. Wings: membranous, well-developed (Fig. 6C, H); R_1 reaching proximal third of wing; R_s forked ($R_{2+3} + R_{4+5}$); R_{4+5} and C joining just before respective apices, ending at same level; R_1 and R_{4+5} posteriorly divergent; M_1 attached to R_{4+5} ; A_1+CuA reaching distal part of the wing; 1 long alular seta. Legs: one dorsal setal palisade on hind tibia (Fig. 7C), posterodorsal row of setulae present (Fig. 6D); foretibia without dorsal setal palisade; distitarsus of every leg subequal in thickness to other tarsomeres; dorsal longitudinal row of 3 spinelike setae along each hind leg tarsomeres, with the exception of basitarsus bearing more than 3 spinelike setae; hind femur without dark spot; ventral isolated spinelike setae at distal apex of hind leg tarsomeres; pulvillus bearing long tenent hairs with solelike spatulate tips on mid- and hind leg (Fig. 6E). Abdomen: tergite 2 anterodorsally elongated; sternites inconspicuous; lateral side of segment 5 (continuing until segment 2, decreasing gradually) bearing deep longitudinal striations; strong constriction after segment 6; end of segment 6 invaginated (Fig. 7). Genitalia: segment 7 (oviscape) of parasitic-type, broad, tubular, posteriorly enlarged and folded (Fig. 6F); segment 6 proximal part setulose, ending inside segment 5; ovipositor sharp, stylet-shaped, postero-dorsally pointed, emerging from under the oviscape posterior fold; 1 pair of minute sclerites under the ovipositor (ventral side).

Male unknown.

Measurements: Body length (head to end of terminalia) 1.3 mm. Head: length 0.22 mm, width 0.35 mm. Scutum: length 0.28 mm, width 0.3 mm. Wing: length 1 mm, width 0.37 mm, costal length 0.45 mm, costal index 0.45, costal ratio 6:1.5:1. Oviscape: length 0.28 mm.

Remarks: The combination of characters showed here does not allow to assign the species to a specific subgroup. With the study of new specimens, this open question could be resolved. The Pseudomyrmecinae and Myrmicinae syninclusions could involve a parasitic relationship

with *Apocephalus dominicanus* n. sp. However, as the specimens are not being displayed interacting closely in the amber piece, the hypothesis remains speculative.

Occurrence: Burdigalian–Langhian; La Toca Formation, Dominican Republic. The age is considered 20 Ma to 15 Ma (Iturralde-Vinent and MacPhee, 1996, 2019; Iturralde-Vinent, 2001).

Apocephalus chiapanecus Solórzano-Kraemer and Brown, n. sp.

(Fig. 8)

LSID: urn:lsid:zoobank.org:act:716CC25F-8EFE-4848-BBAB-22DDC1708CB2.

Etymology: The specific epithet *chiapanecus* refers to the origin of the amber piece in Chiapas, Mexico.

Holotype: Mx-443, housed in the collection of the SMNS, adult female included in Mexican amber, with 19 identified insect syninclusions + dematiaceous hyphomycetes and plant remains: holotype of *Mastigolejeunea extincta* Heinrichs et al., 2015; holotype of *Ceratolejeunea sublaetefusca* Heinrichs et al., 2015; 17 insects [13 Diptera: 10 phorids of the genus *Megaselia* (males and females), 1 *Puliciphora* Dahl, 1897 (male), 1 Cecidomyiidae Newman, 1834 (male), 1 Psychodidae Newman, 1834 (female, probably of the genus *Psychoda* Latreille, 1796); 4 Hymenoptera Linnæus, 1758, of which one is a male representative of Mymaridae Haliday, 1833, genus *Alaptus* Westwood, 1839].

Diagnosis (female): Costa short, wing vein R_{2+3} extremely weak, anepisternum bare. Female abdominal segments one and two constricted, tergite 5 short. Sternite 6 bearing ventral setae.

Description:

Female. (Fig. 8A). Head: 2 pair of proclinate supra-antennal setae; first flagellomere roughly rounded; sensilla of 1st flagellomere uniformly distributed; arista thin, longer than flagellomere 1; proboscis short. Wing: membranous, well-developed; short costa; costal setae thick and spine-like, about 10 pairs (Fig. 8C); R_{2+3} extremely weak. M_1 not attached to R_{4+5} ; A_1+CuA reaching distal part of the wing. Legs: one dorsal setal palisade on hind tibia, posterodorsal row of setulae present; foretibia without dorsal setal palisade. Abdomen: female abdomen with tergite 5 shorter than tergite 4; sternite 6 with more than 10 ventral setae. Genitalia: ovipositor depressed, parasitic type.

Male unknown.

Measurements: Body length 0.96 mm. Wing: length 0.75 mm, costal length 0.2 mm, costal index 0.26, costal ratio 3.5:2:1.

Remarks: The state of conservation does not allow an exhaustive description of the specimen, but some characters can be used for its identification. Though it was deformed during the fossilization process the diagnosis characters on the abdominal segments and the ovipositor are well visible. It has been included in the *Apocephalus grandipalpis*-group Borgmeier, 1925 group because of the short ovipositor (Fig. 8E) — whose dorsal sclerite is narrower than the ventral sclerite (e.g., Borgmeier, 1969, fig. 39) (Fig. 8F) — the frontal setal pattern (Fig. 8B) (e.g., Borgmeier, 1925, fig. 22) (Fig. 8D), the beaklike oviscape, and the bowed anterior processes of the stylet (Brown, 1997). The *A. grandipalpis*-group was hypothesized to be monophyletic (Brown, 1997) and later confirmed as a strongly supported clade (Brown et al., 2018a). Most species have been found to be parasitoids of the enormous ant genus *Pheidole* Westwood, 1839, including some that are parasitoids of ant larvae or pupae (Brown et al., 2017). Besides the type species of the group (*A. grandipalpis* Borgmeier), some species are known from South America and the USA. The group is in need of revision, however, and there are numerous, perhaps hundreds of undescribed species. We doubt that any of them could be conspecific with *A. chiapanecus*, however, given the great period of time that has elapsed since this specimen was alive.

Occurrence: Aquitanian; La Quinta Formation, Simojovel, Mexico. The age is considered 22.8 Ma (Perrilliat et al., 2010; Serrano-Sánchez et al., 2015).

Key to described *Apocephalus* fossil species (female):

1. Two pairs of supra-antennal setae 2
 - One pair of supra-antennal setae 3
2. Oviscape broad, straight, tubular (Fig. 5A, B) ... *Apocephalus succineus* Brown, 2000
 - Oviscape narrow, depressed, short (Fig. 8E) ... *Apocephalus chiapanecus* Solórzano-Kraemer and Brown, n. sp.
3. Strong invaginated constriction after abdominal segment 5; ovipositor straight, narrow, stylet-shaped (Fig. 6F) *Apocephalus dominicanus* Solórzano-Kraemer, Rosse-Guillevic and Brown, n. sp.
 - No such abdominal constriction after segment 5; ovipositor dorsoventrally curved, not stylet-shaped (Fig. 3E) *Apocephalus miocenus* Solórzano-Kraemer, Bourdeau and Brown, n. sp.

5. Discussion

In amber, Phoridae are among the most common inclusions in Mexican and Dominican ambers (Solórzano Kraemer et al., 2015). However, parasitic phorids are not as abundant as groups that have many scavengers like *Megaselia*, *Dohrniphora* Dahl, 1898, or *Puliciphora* (Solórzano Kraemer and Brown, 2018; Solórzano Kraemer et al., 2018). Nowadays, in tropical forests, *Megaselia* is the most abundant and diverse phorid genus (Brown et al., 2018a), and Miocene amber forests do not seem to be any different. Parasitic phorids have specific hosts such as bees, wasps, or millipedes. All known hosts are well represented in fossil resins; thus, it is probably only a matter of time before finding more parasitic phorids in amber deposits. For example, the females of the *Apocephalus miricauda* group are attracted to injured hosts (Brown, 2000), so it is not surprising that the majority of the fossil species belong to this group. Trapped hosts would emit alarm pheromones, which would be highly attractive to these flies (Feener et al., 1996).

Hash et al. (2018) raised the hypothesis that the Asian *Myriophora* should have originated from a single dispersal event during the Miocene, coming from the Nearctic region. This hypothesis was strongly supported by their work on the molecular-only phylogenetic tree for the genus. The discovery of *M. asiatica* n. sp. in the Miocene of China supports this dispersal scenario. *Myriophora* has also been recorded from Dominican amber (Brown, 1999), which is dated from Early Miocene (Iturralde-Vinent and MacPhee, 1996), hence strengthening the single dispersal from the New World hypothesis. Furthermore, those new occurrences in the fossil record bring new calibration points for future phylogenetic studies of the Phoridae family.

Acknowledgments

We thank Mr. Jorge Caridad (World Amber Museum, Santo Domingo) and his family for the loan of the piece MNHNSD FOS 17.02 for studying purposes, and for its donation to the Museo Nacional de Historia Natural “Prof. Eugenio de Jesús Marcano”, Santo Domingo. We thank Carlos Suriel (Museo Nacional de Historia Natural “Prof. Eugenio de Jesús Marcano”) for including it in the collection, Bo Wang (Chinese Academy of Sciences, Nanjing) for the loan of the piece NIGP177329, Michael W. Rasser (Staatliches Museum für Naturkunde Stuttgart) for the loan of the pieces Do-369-K, Do-1059-K, and Mx-443. We thank Xavier Delclòs (University of Barcelona) and Enrique Peñalver (Geominero Museum, IGME) for the important discussion during the revision of the Dominican amber collection. The authors are grateful to Robin Kunz (Senckenberg Research Institute and Natural History Museum Frankfurt) for the technical support to prepare the amber material, taking photographs and

segmentation. Part of the work resulted from an Internship of C.B. and S.R.-G. in the Senckenberg Research Institute during the beginning of 2019 and 2021. We thank the German VolkswagenStiftung (Project N. 90946), the Strategic Priority Research Program of the Chinese Academy of Sciences (XDB26000000), National Natural Science Foundation of China (41688103), and the Deutsches Elektronen Synchrotron (DESY) in Hamburg [BAG-20210019] for financial support and beamline time. This is a contribution to DFG Project SO 894/6-1. The comments of Enrique Peñalver and Corentin Jouault also improved the manuscript.

References

- Arillo, A., Mostovski, M.B., 1999. A new genus of *Prioriphorinae* (Diptera, Phoridae) from the Lower Cretaceous amber of Alava (Spain). *Studia dipterologica* 6 (2), 251–255.
- Blume, C.L. von, 1825. *Bijdragen tot de flora van Nederlandsch Indië. 1ste Stuck, Batavia, Ter Lands Drukkerij, 284 pp.*
- Borgmeier, T., 1925. *Novos subsidios para o conhecimento da familia Phoridae (Dipt.)*. *Arquivos do Museu Nacional do Rio de Janeiro* 25, 85–281.
- Borgmeier, T., 1963. *Revision of the North American phorid flies. Part I. The Phorinae, Aenigmatinae and Metopininae, except Megaselia (Diptera, Phoridae)*. *Studia Entomologica* 6, 1–256.
- Borgmeier, T., 1969. *New or little-known phorid flies, mainly of the Neotropical region (Diptera: Phoridae)*. *Studia Entomologica* 12, 33–132.
- Borgmeier, T., 1971. *Further studies on phorid flies, mainly of the Neotropical Region (Diptera, Phoridae)*. *Studia Entomologica* 14, 1–172.
- Brown, B.V., 1992. *Generic revision of Phoridae of the Nearctic Region and phylogenetic classification of Phoridae, Sciadoceridae, and Ironomyiidae (Diptera: Phoridae)*. *The Memoirs of the Entomological Society of Canada* 124 (S164), 3–144.
- Brown, B.V., 1993. Taxonomy and preliminary phylogeny of the parasitic genus *Apocephalus*, subgenus *Mesophora* (Diptera: Phoridae). *Systematic Entomology* 18, 191–230.
- Brown, B.V., 1994. Revision and new species of the *Apocephalus* (*Mesophora*) *truncaticercus*-infragroup (Diptera: Phoridae). *Contributions in Science (Los Angeles)* 449, 1–7.

- Brown, B.V., 1996a. Preliminary analysis of a host shift: revision of the Neotropical species of *Apocephalus*, subgenus *Mesophora* (Diptera: Phoridae). *Contributions in Science (Los Angeles)* 462, 1–36.
- Brown, B.V., 1996b. A further species of *Apocephalus*, subgenus *Mesophora* (Diptera: Phoridae) parasitic on stingless bees (Hymenoptera: Apidae: Meliponinae). *Studia dipterologica* 3, 231–235.
- Brown, B.V., 1997. Revisión del grupo *attophilus* del género *Apocephalus* de moscas decapitadoras de hormigas (Diptera: Phoridae) [Revision of the *Apocephalus attophilus*-group of ant-decapitating flies (Diptera: Phoridae)]. *Contributions in Science (Los Angeles)* 468, 1–60.
- Brown, B.V., 1999. Re-evaluation of the fossil Phoridae (Diptera). *Journal of Natural History* 33 (10), 1561–1573.
- Brown, B. V., 2000. Revisión del grupo “*Apocephalus miricauda*” de moscas parasitoides de hormigas (Diptera: Phoridae) [Revision of the “*Apocephalus miricauda*-Group” of ant-parasitizing flies (Diptera: Phoridae)]. *Contributions in Science (Los Angeles)* 482, 1–62.
- Brown, B.V., 2012. Revision of the *Apocephalus mucronatus* group of ant decapitating flies (Diptera: Phoridae). *Zootaxa* 3413, 19–28.
- Brown, B.V., 2014. Revision of the *Apocephalus analis* group of ant-decapitating flies (Diptera: Phoridae). *Zootaxa* 3857, 551–570.
- Brown, B.V., Kung, G., 2007. Revision of the New World *Dohniphora* Dahl species with hind tibial setae (Diptera: Phoridae). *Arthropod Systematics & Phylogeny* 65 (2), 157–237.
- Brown, B.V., Kung, G., 2010. Revision of the New World *Dohniphora* Dahl species lacking large hind tibial setae (Diptera: Phoridae). *Zootaxa* 2699 (1), 1–142.
- Brown, B.V., Pike, E.M., 1990. Three new fossil phorid flies (Diptera: Phoridae) from Canadian Late Cretaceous amber. *Canadian Journal of Earth Sciences* 27 (6), 845–848.
- Brown, B.V., Borkent, A., Cumming, J.M., Wood, D.M., Woodley, N.E., Zumbado, M., 2010. *Manual of Central American Diptera, Vol. 2*. NRC Research Press, Ottawa, 728 pp.
- Brown, B.V., Hash, J.M., Hartop, E.A., Porras, W., De Souza Amorim, D., 2017. Baby killers: documentation and evolution of scuttle fly (Diptera: Phoridae) parasitism of ant (Hymenoptera: Formicidae) brood. *Biodiversity Data Journal* 5, e11277, doi: 10.3897/BDJ.5.e11277.

- Brown, B.V., Hayes, C., Hash, J.M., Smith, P.T., 2018a. Molecular phylogeny of the ant-decapitating flies, genus *Apocephalus* Coquillett (Diptera: Phoridae). *Insect Systematics and Diversity* 2 (4), 1–8.
- Brown, B.V., Borkent, A., Adler, P.H., de Souza Amorim, D., Barber, K., Bickel, D., Boucher, S., Brooks, S.E., Burger, J., Burington, Z.L., Capellari, R.S., Costa, D.N.R., Cumming, J.M., Curler, G., Dick, C.W., Epler, J.H., Fisher, E., Gaimari, S.D., Gelhaus, J., Grimaldi, D.A., Hash, J., Hauser, M., Hippa, H., Ibáñez-Bernal, S., Jaschhof, M., Kameneva, E.P., Kerr, P.H., Korneyev, V., Korytkowski, C.A., Kung, G.-A., Mikalsen Kvifte, G., Lonsdale, O., Marshall, S.A., Mathis, W., Michelsen, V., Naglis, S., Norrbom, A.L., Paiero, S., Pape, T., Pereira-Colavite, A., Pollet, M., Rochefort, S., Rung, A., Runyon, J.B., Savage, J., Silva, V.C., Sinclair, B.J., Skevington, J.H., Stireman III, J.O., Swann, J., Thompson, F.C., Vilkkamaa, P., Wheeler, T., Whitworth, T., Wong, M., Wood, D.M., Woodley, N., Yau, T., Zavortink, T.J., Zumbado, M.A., 2018b. Comprehensive inventory of true flies (Diptera) at a tropical site. *Communications Biology* 1, Article number 21, doi: 10.1038/s42003-018-0022-x.
- Brues, C.T., 1904. A monograph of the North American Phoridae. *Transactions of the American Entomological Society* 29, 369–404.
- Brues, C.T., 1905. Phoridae from the Indo-Australian Region. *Annales Historico-Naturales Musei Nationalis Hungarici* 3, 541–555.
- Calvillo-Canadell, L., Cevallos-Ferriz, S.R., Rico-Arce, L., 2010. Miocene Hymenaea flowers preserved in amber from Simojovel de Allende, Chiapas, Mexico. *Review of Palaeobotany and Palynology* 160, 126–134.
- Clerck, C., 1757. *Aranei svecici, descriptionibus et figuris aeneis illustrati, ad genera subalterna redacti, speciebus ultra LX determinati, auspiciis regiae soci-etatis scientiarum Upsalensis*. Salvius, Stockholm, 154 pp.
- Coquillett, D.W., 1901. *Apocephalus* n. gen. In: Pergande, T. (Ed.), *The Ant Decapitating Fly*. *Proceedings of the Entomological Society of Washington* 4, 501.
- Coquillett, D.W., 1907. A new phorid genus with horny ovipositor. *The Canadian Entomologist* 39, 207–208.
- Core, A., Runckel, C., Ivers, J., Quock, C., Siapno, T., DeNault, S., Brown, B., DeRisi, J., Smith, C.D., Hafernik, J., 2012. A new threat to honey bees, the parasitic phorid fly *Apocephalus borealis*. *PLoS ONE* 7 (1), e29639, doi: 10.1371/journal.pone.0029639.

- Cumming, J.M., Wood, D.M., 2017. Adult morphology and terminology [chapter 3]. In: Kirk-Spriggs, A.H., Sinclair, B.J. (Eds.), *Manual of Afrotropical Diptera, Vol. 1, Suricata 4*. SANBI Publications, Pretoria, pp. 89–133.
- Curtis, J., 1833. *British entomology, being illustrations and descriptions of the genera of insects found in Great Britain and Ireland, Vol. 10*. Richard Taylor, London, 202 pp.
- Dahl, T., 1897. *Puliciphora, eine neue flohaenliche Fliegengattung*. *Zoologischer Anzeiger* 20, 405–412.
- Dahl, F., 1898. *Ueber den Floh and seine Stellung im System*. *Sitzungsbericht der Gesellschaft Naturforschende Freude zu Berlin* 10, 185–199.
- Disney, R.H.L., 1978. A new species of afrotropical *Megaselia* (Diptera: Phoridae), with a re-evaluation of the genus *Plastophora*. *Zeitschrift für angewandte Zoologie* 65, 313–319.
- Disney, R.H.L., 1994. *Scuttle Flies: the Phoridae*. Chapman and Hall, London, 467 pp.
- Evenhuis, N.L., 1994. *Catalogue of the Fossil Flies of the World (Insecta: Diptera)*. Backhuys Publishers, Leiden, 600 pp.
- Feener Jr., D.H., Jacobs, L.F., Schmidt, J.O., 1996. Specialized parasitoid attracted to a pheromone of ants. *Animal Behavior* 51, 61–66.
- Gaston, K.J., 1991. The magnitude of global insect species richness. *Conservation Biology* 5, 283–296.
- Greving, I., Wilde, F., Ogurreck, M., Herzen, J., Hammel, J.U., Hipp, A., Friedrich, F., Lottermoser, L., Dose, T., Burmester, H., Müller, M., Beckmann, F., 2014. P05 imaging beamline at PETRA III: first results. *Proceedings of SPIE* 9212, 921200.
- Haliday, A.H., 1833. An essay on the classification of the parasitic Hymenoptera of Britain, which correspond with the *Ichneumones minuti* of Linnaeus. *Entomological Magazine* 1, 259–276.
- Haliday, A.H., 1836. An epitome of the British genera, in the Order Thysanoptera, with indications of a few of the species. *Entomological Magazine* 3, 439–451.
- Hash, J.M., Brown, B.V., 2015. Revision of the New World species of the millipede-parasitic genus *Myriophora* Brown (Diptera: Phoridae). *Zootaxa* 4035 (1), 1–79.
- Hash, J.M., Heraty, J.M., Brown, B.V., 2018. Phylogeny, host association and biogeographical patterns in the diverse millipede-parasitoid genus *Myriophora* Brown (Diptera: Phoridae). *Cladistics* 34 (1), 93–112.
- Heinrichs, J., Kettunen, E., Lee, G.E., Marzaro, G., Pócs, T., Ragazzi, E., Renner, M., Rikkinen, J., Sass-Gyarmati, A., Schäfer-Verwimp, A., Scheben, A., Solórzano

- Kraemer, M.M., Svojtka, M., Schmidt, A.R., 2015. Lejeuneaceae (Marchantiophyta) from a species-rich taphocoenosis in Miocene Mexican amber, with a review of liverworts fossilised in amber. Review of Palaeobotany and Palynology 221, 59–70.*
- Heraty, J., 2009. Parasitoid biodiversity and insect pest management. In: Footitt, R.G., Adler, P.H. (Eds.), Insect Biodiversity, Vol. 1. Wiley-Blackwell, Hoboken, pp. 603–625.*
- [Ho, K., Chen, J., Lo, C., Zhao, H., 2003. ⁴⁰Ar–³⁹Ar dating and geochemical characteristics of late Cenozoic basaltic rocks from the Zhejiang-Fujian region, SE China: eruption ages, magma evolution and petrogenesis. Chemical Geology 197, 287–318.](#)
- [Iturralde-Vinent, M.A., 2001. Geology of the amber-bearing deposits of the Greater Antilles. Caribbean Journal of Science 37 \(3/4\), 141–167.](#)
- [Iturralde-Vinent, M.A., MacPhee, R.D., 1996. Age and paleogeographical origin of Dominican amber. Science 273 \(5283\), 1850–1852.](#)
- [Iturralde-Vinent, M.A., MacPhee, R.D., 2019. Remarks on the age of Dominican amber. Palaeoentomology 2 \(3\), 236–240.](#)
- [Jacques, F.M.B., Shi, G., Su, T., Zhou, Z., 2015. A tropical forest of the middle Miocene of Fujian \(SE China\) reveals Sino-Indian biogeographic affinities. Review of Palaeobotany and Palynology 216, 76–91.](#)
- [Latreille, P.A., 1796. Precis des caractères génériques des insectes, disposés dans un ordre naturel par le citoyen Latreille. Brive, Bordeaux, 210 pp.](#)
- [Latreille, P.A., 1809. Genera crustaceorum et insectorum secundum ordinem naturalem in familias disposita, iconibus exemplisque plurimis explicata, Vol. 4. A. Koenig, Paris and Strasbourg, 399 pp.](#)
- [Latreille, P.A., 1817. Les crustacés, les arachnides et les insectes. Le règne animal distribué d'après son organization: pour servir de base à l'histoire naturelle des animaux et d'introduction à anatomie comparée, Vol. 3. A. Belin, Paris, 653 pp.](#)
- [Lepeletier de Saint-Fargeau, A., 1835. Histoire naturelle des insectes. Hyménoptères, Vol. 1. Roret, Paris, 547 pp.](#)
- [Lindley, J., 1836. A Natural System of Botany, or, A systematic view of the organization, natural affinities, and geographical distribution, of the whole vegetable kingdom: together with the uses of the most important species in medicine, the arts, and rural or domestic economy. Longman, Rees, Orme, Brown, Green, and Longmans, London, 526 pp.](#)

- Linnæus, C., 1753. *Species plantarum: exhibentes plantas rite cognitatas, ad genera relatas, cum differentiis specificis, nominibus trivialibus, synonymis selectis, locis natalibus, secundum systema sexuale digestas*. Salvius, Stockholm, 1200 pp.
- Linnæus, C., 1758. *Systema naturæ per regna tria naturæ, secundum classes, ordines, genera, species, cum characteribus, differentiis, synonymis, locis, Vol. 1. Editio decima, reformata*. Salvius, Stockholm, 824 pp.
- Lund, P.W., 1831. *Ueber die Lebensweise einiger brasilianischer Ameisen. Notizen aus dem Gebiete der Natur- und Heilkunde* 32, 97–106.
- Lytaev, P., Hipp, A., Lottermoser, L., Herzen, J., Greving, I., Khokhriakov, I., Meyer-Loges, S., Plewka, J., Burmester, J., Caselle, M., Vogelgesang, M., Chilingaryan, S., Kopmann, A., Balzer, M., Schreyer, A., Beckmann, F., 2014. Characterization of the CCD and CMOS cameras for grating-based phase-contrast tomography. *SPIE Optical Engineering + Applications* 9212, 10.
- McAlpine, J.F., Martin, J.E.H., 1966. *Systematics of Sciadoceridae and relatives with descriptions of two new genera and species from Canadian amber and erection of family Ironomyiidae (Diptera: Phoroidea)*. *The Canadian Entomologist* 98, 527–544.
- Moosmann, J., Ershov, A., Weinhardt, V., Baumbach, T., Prasad, M.S., LaBonne, C., Xiao, X., Kashef, J., Hoffmann, R., 2014. Time-lapse X-ray phase-contrast microtomography for in vivo imaging and analysis of morphogenesis. *Nature Protocols* 9, 294–304.
- Newman, E., 1834. *Attempted division on British insects into natural orders*. *Entomologist's Magazine* 2, 195–227.
- Palenstijn, W.J., Batenburg, K.J., Sijbers, J., 2011. Performance improvements for iterative electron tomography reconstruction using graphics processing units (GPUs). *Journal of Structural Biology* 176 (2), 250–253.
- Perrilliat, M., Vega, F.J., Coutiño, M.A., 2010. *Miocene mollusks from the Simojovel area in Chiapas, southwestern Mexico*. *Journal of South American Earth Sciences* 30 (2), 111–119.
- Perrichot, V., 2004. *Early Cretaceous amber from south-western France: insight into the Mesozoic litter fauna*. *Geologica Acta* 2 (1), 9–22.
- Poinar Jr., G.O., 1991. *Hymenaea protera sp. n. (Leguminosae, Caesalpinioideae) from Dominican amber has African affinities*. *Experientia* 47 (10), 1075–1082.

- Poinar Jr., G.O., Brown, A.E., 2002. *Hymenaea mexicana* sp. nov. (Leguminosae: Caesalpinioideae) from Mexican amber indicates Old World connections. *Botanical Journal of the Linnean Society* 139 (2), 125–132.
- Rondani, C., 1856. *Dipterologiae Italicae Prodromus. Genera italica ordinis Diptero-
ordinatim disposita et distincta et in familias et stirpes aggregata, Vol. 1. A. Stocchi,
Parma, 226 pp.*
- Serrano-Sánchez, M.L., Hegna, T.A., Schaaf, P., Pérez, L., Centeno-García, E., Vega, F.J., 2015. The aquatic and semiaquatic biota in Miocene amber from the Campo La Granja mine (Chiapas, Mexico): Paleoenvironmental implications. *Journal of South American Earth Sciences* 62, 243–256.
- Shi, G., Dutta, S., Paul, S., Wang, B., Jacques, F.M.B., 2014a. Terpenoid compositions and botanical origins of Late Cretaceous and Miocene amber from China. *PloS ONE* 9 (10), e111303, doi: 10.1371/journal.pone.0111303.
- Shi, G., Jacques, F.M.B., Li, H., 2014b. Winged fruits of *Shorea* (Dipterocarpaceae) from the Miocene of southeast China: evidence for the northward extension of dipterocarps during the Mid-Miocene Climatic Optimum. *Review of Palaeobotany and Palynology* 200, 97–107.
- Smith, M.R., 1952. The correct name for the group of ants formerly known as *Pseudomyrma* (Hymenoptera). *Proceedings of the Entomological Society of Washington* 54, 97–98.
- Solórzano Kraemer, M.M., 2007. Systematic, palaeoecology, and palaeobiogeography of the insect fauna from Mexican amber. *Palaeontographica Abteilung A* 282, 1–133.
- Solórzano Kraemer, M.M., Brown, B.V., 2018. *Dohrniphora* (Diptera: Phoridae) from the Miocene Mexican and Dominican ambers with a paleobiological reconstruction. *Insect Systematics & Evolution* 49 (3), 299–327.
- Solórzano Kraemer, M.M., Perrichot, V., Brown, B.V., Tafforeau, P., Soriano, C., 2011. A new species of the Cretaceous genus *Prioriphora* (Diptera: Phoridae) in French amber. *Systematic Entomology* 36 (3), 581–588.
- Solórzano Kraemer, M.M., Kraemer, A.S., Stebner, F., Bickel, D.J., Rust, J., 2015. Entrapment bias of arthropods in Miocene amber revealed by trapping experiments in a tropical forest in Chiapas, Mexico. *PloS ONE* 10 (3), e0118820, doi: 10.1371/journal.pone.0118820.
- Solórzano Kraemer, M.M., Delclòs, X., Clapham, M.E., Arillo, A., Peris, D., Jäger, P., Stebner, F., Peñalver, E., 2018. Arthropods in modern resins reveal if amber

- accurately recorded forest arthropod communities. Proceedings of the National Academy of Sciences of the United States of America* 115 (26), 6739–6744.
- Srivathsan, A., Hartop, E., Puniamoorthy, J., Lee, W.T., Kutty, S.N., Kurina, O., Meier, R., 2019. Rapid, large-scale species discovery in hyperdiverse taxa using 1D MinION sequencing. *BMC Biology* 17 (1), 1–20.
- van Aarle, W., Palenstijn, W.J., De Beenhouwer, J., Altantzis, T., Bals, S., Batenburg, K.J., Sijbers, J., 2015. The ASTRA Toolbox: A platform for advanced algorithm development in electron tomography. *Ultramicroscopy* 157, 3547.
- van Aarle, W., Palenstijn, W.J., Cant, J.J., Janssens, E., Bleichrodt, F., Dabrovolski, A., De Beenhouwer, J., Batenburg, K.J., Sijbers, J., 2016. Fast and flexible X-ray tomography using the ASTRA Toolbox. *Optics Express* 24 (22), 25129–25147
- Wang, B., Shi, G., Xu, C., Spicer, R., Perrichot, V., Schmidt, A.R., Feldberg, K., Heinrichs, J., Chény, C., Pang, H., Liu, X., Gao, T., Wang, X., Ślipiński, A., Solórzano-Kraemer, M.M., Heads, S., Sadowski, E.M., Szwedo, J., Azar, D., Nel, A., Liu, Y., Chen, J., Zhang, Q., Zhang, Q., Luo, C., Yu, T., Zheng, D., Zhang, H., Engel, M.S., 2021. Zhangpu biota reveals the richest Cenozoic rainforest biome. *Science Advances* 7 (18), eabg0625, doi: 10.1126/sciadv.abg0625.
- Westwood, J.O., 1839. *An introduction to the modern classification of insects; founded on the natural habits and corresponding organisation of the different families, Vol. 2, Part XI.* Longman, Orme, Brown, Green, and Longmans, London, 462 pp.
- Westwood, J.O., 1840. Observations on the genus *Typhlopone*, with descriptions of several exotic species of ants. *Annals and Magazine of Natural History* 6, 81–89.
- Wilde, F., Ogurreck, M., Greving, I., Schreyer, A., 2016. Micro-CT at the imaging beamline P05 at PETRA III. *AIP Conference Proceedings* 1741 (1), 030035.
- Zheng, D., Shi, G., Hemming, S.R., Zhang, H., Wang, W., Wang, B., Chang, S.C., 2019. Age constraints on a Neogene tropical rainforest in China and its relation to the Middle Miocene Climatic Optimum. *Palaeogeography, Palaeoclimatology, Palaeoecology* 518, 82–88.

Figures captions

Fig. 1. *Myriophora asiatica* n. sp., holotype NIGP177329 (♀) in Zhangpu amber. (A) Habitus, lateral right view. (B) Habitus, ventral view. (C) Head, frontal view. (D) Head, dorsal view. (E) Thorax, dorsal view. (F) Scutellum, dorsal view. Scale bar: 0.5 mm for (A, B); 0.1 mm for (C–F). Abbreviations: a sctl s = anterior scutellar seta; l infr s = lower interfrontal seta; p sctl s = posterior scutellar seta; o vt s = outer vertical seta; poc s = postocellar seta; spant s = supra-antennal seta.

Fig. 2. *Myriophora asiatica* n. sp., holotype NIGP177329 (♀) in Zhangpu amber. (A) Wing (right, basal part), dorsal view. (B) Wing (right, basal part), lateral view. (C) Habitus, dorsal view. (D) Genitalia, dorsal view. (E) Genitalia, ventral view. (F) Ovipositor (apex). (G) Head, latero-frontal view, line drawing. (H) Wing (right), dorsal view, line drawing. Scale bar: 0.1 mm for (A, B, E, F); 0.5 mm for (C, H); 0.2 mm for (D); 0.25 mm for (G). Abbreviations: ar = arista; b cost = basicosta; C = costal vein; flgm 1 = flagellomere 1; M = medial veins; ml = midline; om = ommatidium; R = radial veins; spant s = supra-antennal seta; teg = tegula.

Fig. 3. *Apocephalus miocenus* n. sp., holotype female Do-369-K (♀) in Dominican amber. (A) Habitus, lateral right view. (B) Head, latero-frontal view. (C) Wing (left), lateral view. (D) Abdomen, lateral view. (E) Abdomen, dorsal view. (F) Head, latero-frontal view, line drawing. (G) Wing (left), line drawing. Scale bar: 0.5 mm for (A–E, G); 0.2 mm for (F). Abbreviations: ar = arista; C = costal vein; flgm 1 = flagellomere 1; forb s = fronto orbital seta; h = humeral crossvein; M = medial veins; ml = midline; om = ommatidium; R = radial veins; spant s = supra-antennal seta; u infr s = upper interfrontal seta.

Fig. 4. *Apocephalus succineus* Brown, 2000, paratype Do-1059-K (♀) in Dominican amber. (A) Habitus, lateral right view. (B) Habitus, lateral left view. (C) Head, lateral view. (D) Wing (left). (E) Head, frontal view. Scale bar: 0.5 mm for (A, B, D, E); 0.1 mm for (C).

Fig. 5. *Apocephalus succineus* Brown, 2000, paratype Do-1059-K (♀) in Dominican amber. (A) Genitalia, lateral right view. (B) Oviscape, lateral left view. (C) Abdomen, dorsal view. (D) Head, frontal view, line drawing. (E) Wing (left), lateral view, line drawing. Scale bar: 0.5 mm for (A, C, D); 0.1 mm for (B); 0.2 mm for (E). Abbreviations: ar = arista; C = costal vein; flgm 1 = flagellomere 1; M = medial veins; ml = midline; om = ommatidium; R = radial veins; spant s = supra-antennal seta.

Fig. 6. *Apocephalus dominicanus* n. sp., holotype MNHNSD FOS 17.02 (♀) in Dominican amber. (A) Habitus, lateral left view. (B) Head, frontal view. (C) Wings, dorsal view. (D) Hind leg, lateral left view. (E) Tenent hairs, lateral left view. (F) Terminalia, lateral left view. (G) Head, frontal view, line drawing. (H) Wing (right), dorsal view, line drawing. Scale bar: 0.5 mm for (A, C, H); 0.1 mm for (B, G); 0.2 mm for (D); 0.02 mm for (E); 0.125 mm for (F). Abbreviations: A = anal vein; ar = arista; C = costal vein; CuA = anterior branch of cubital vein; dor s pal = dorsal setal palissade; flgm 1 = flagellomere 1; M = medial veins; ml = midline; om = ommatidium; ovp = ovipositor; ovscp = oviscapae; pdor spl s = posterodorsal spinelike seta; R = radial veins; spant s = supra-antennal seta; t h = tenent hairs.

Fig. 7. Virtual representation of *Apocephalus dominicanus* n. sp., holotype MNHNSD FOS 17.02 (♀) in Dominican amber. (A) Habitus, lateral right view. (B) Habitus, lateral left view. (C) Hind leg (left), lateral view. (D) Habitus, dorsal view. (E) Habitus, ventral view. Scale bar: 0.5 mm. Abbreviation: dor s pal = dorsal setal palisade.

Fig. 8. (A–C, E) *Apocephalus chiapanecus* n. sp., holotype Mx-443 (♀) in Mexican amber from Simojovel, Chiapas; (A) habitus, dorsal view; (B) head setae; (C) wing (right, basal parts); (E) terminalia, dorsal left view. (D) Head setae from *Apocephalus grandipalpis* Borgmeier, 1925, male, original description (Borgmeier, 1925, fig. 22). (F) Ovipositor of *Apocephalus mexicanus* Borgmeier, 1969 (Borgmeier, 1969, fig. 39) length 0.39 mm. Scale bar: 0.1 mm for (A, C); 0.05 mm for (B, E); without scale in the original figure for (D, F). Abbreviation: spant s = supra-antennal setae.

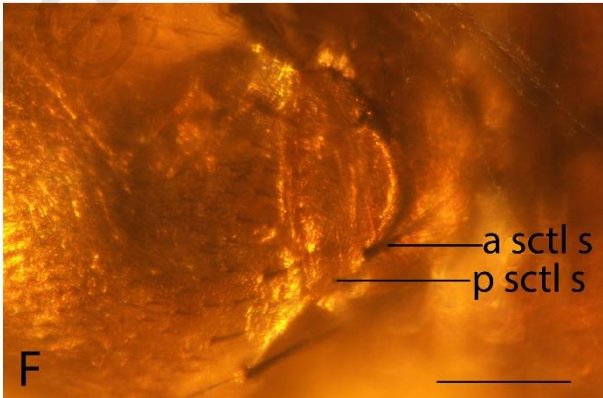
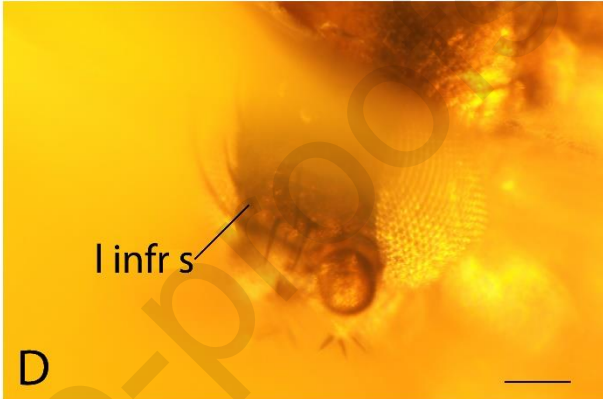

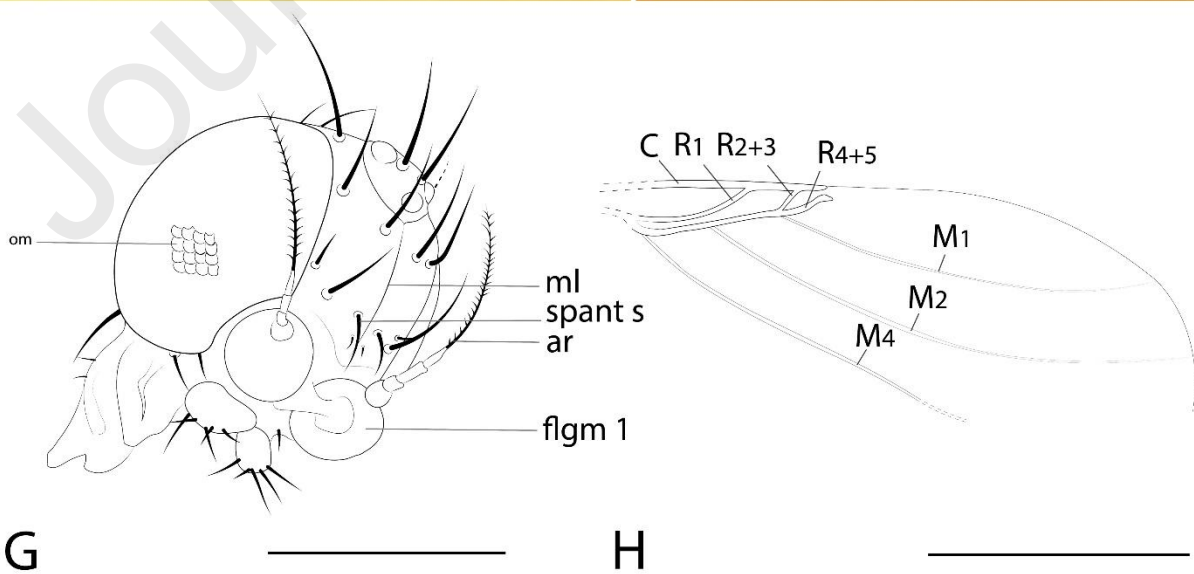
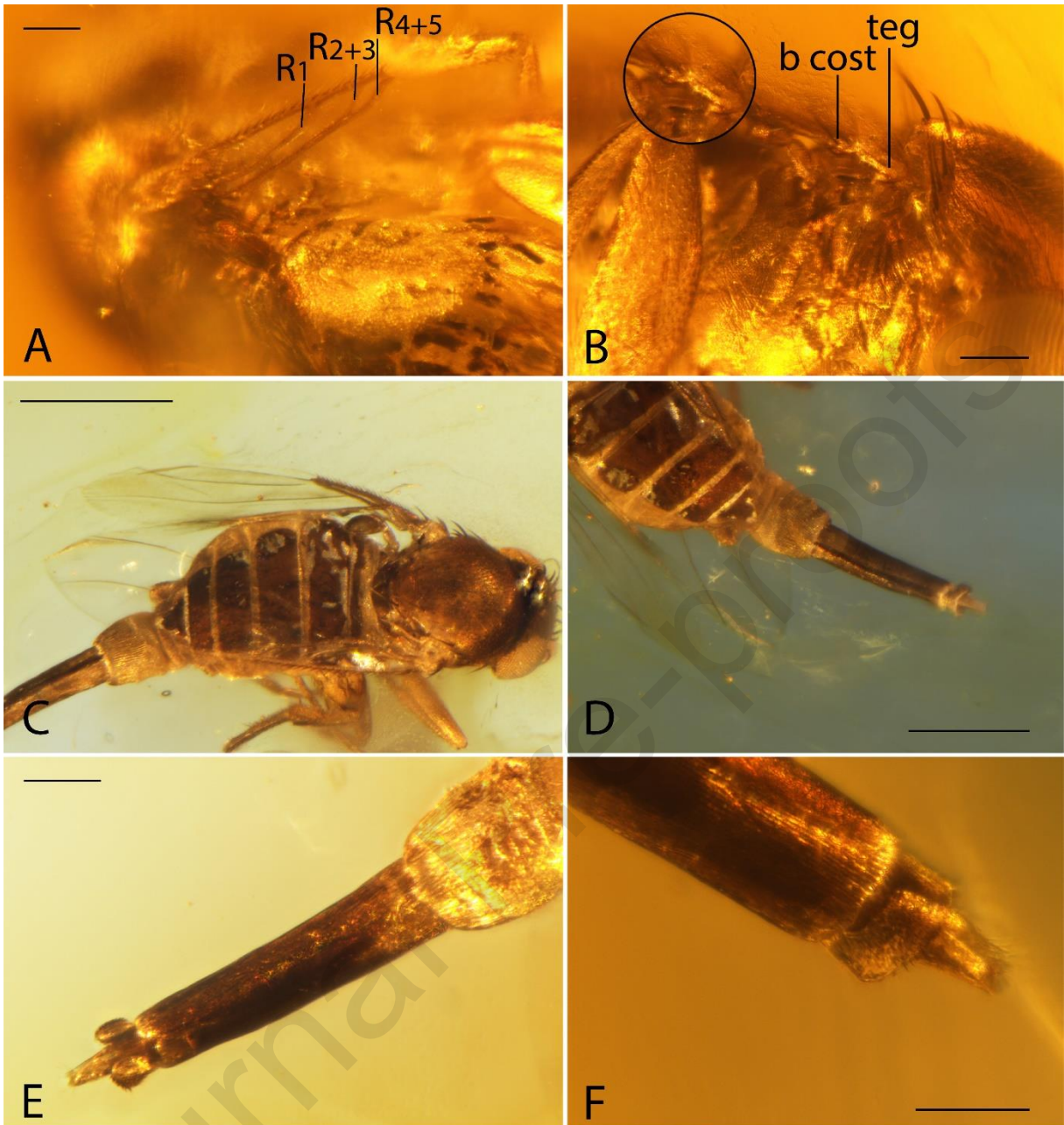

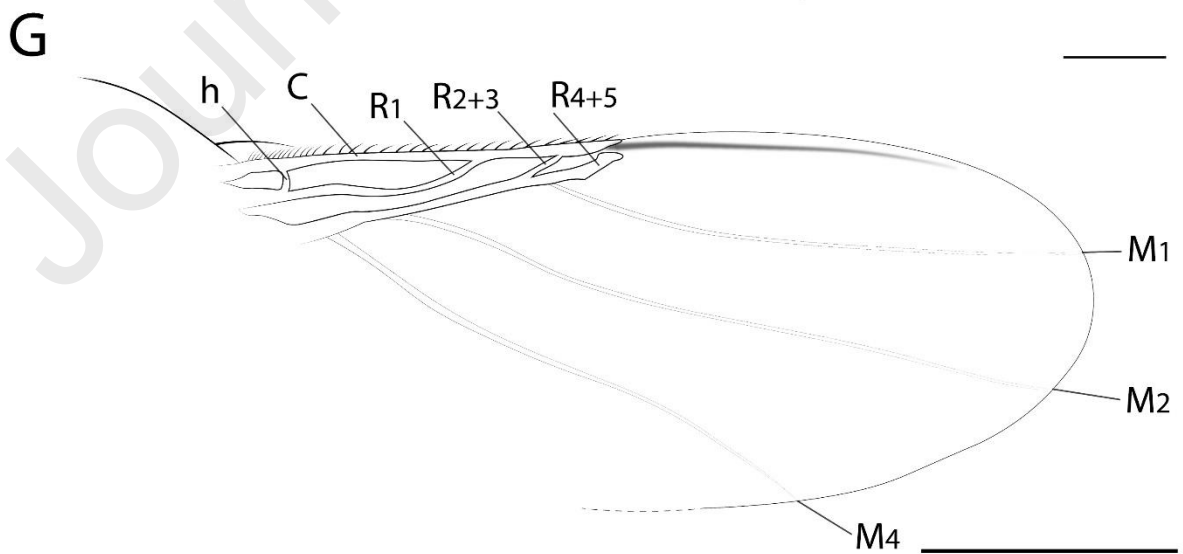
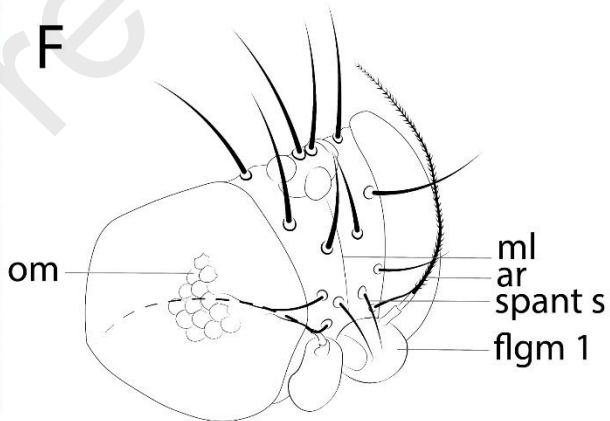
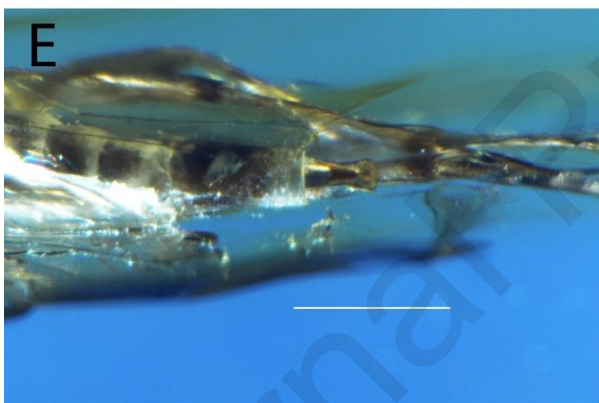
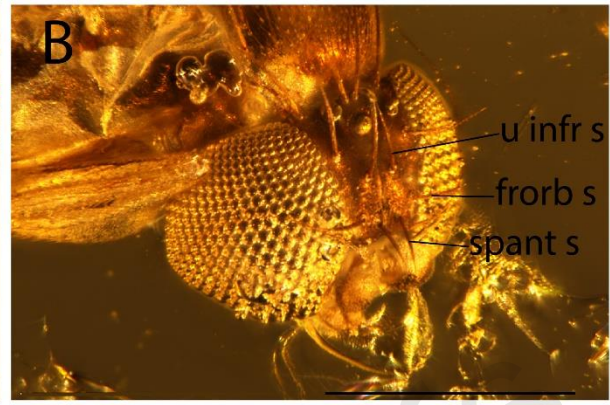

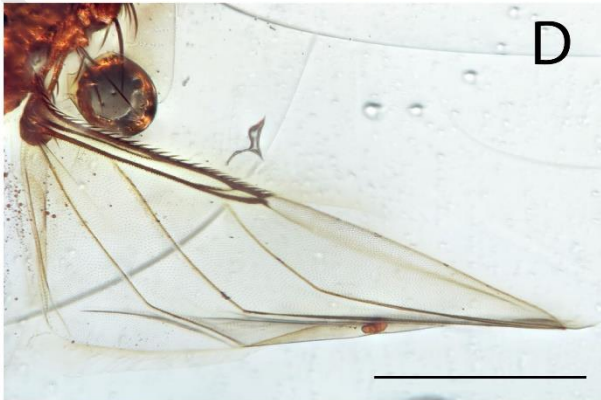

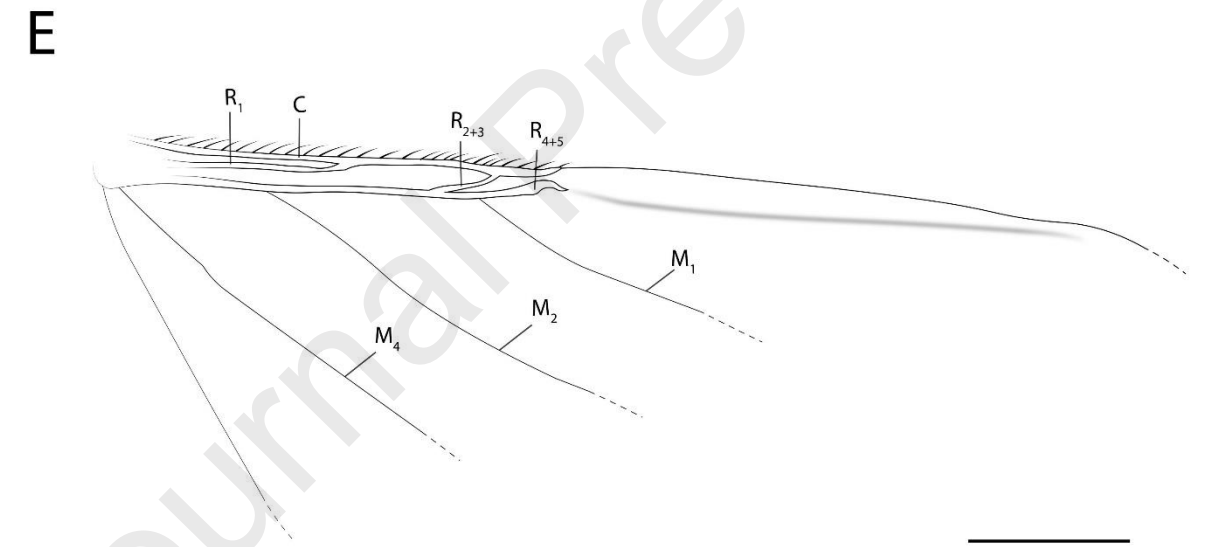
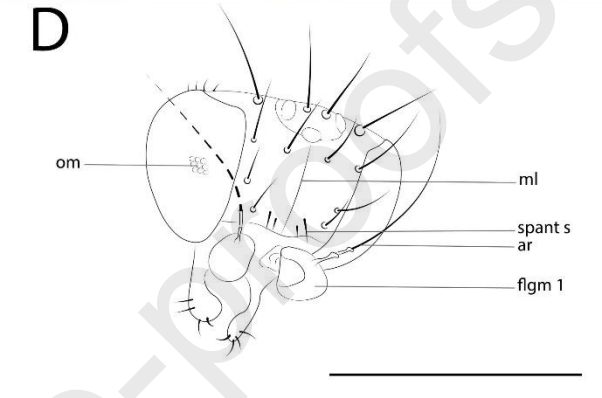
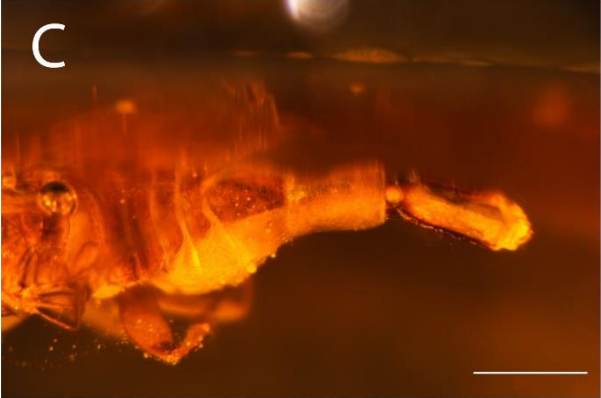
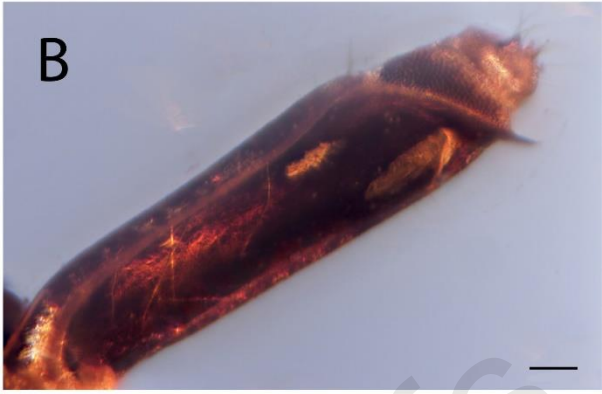

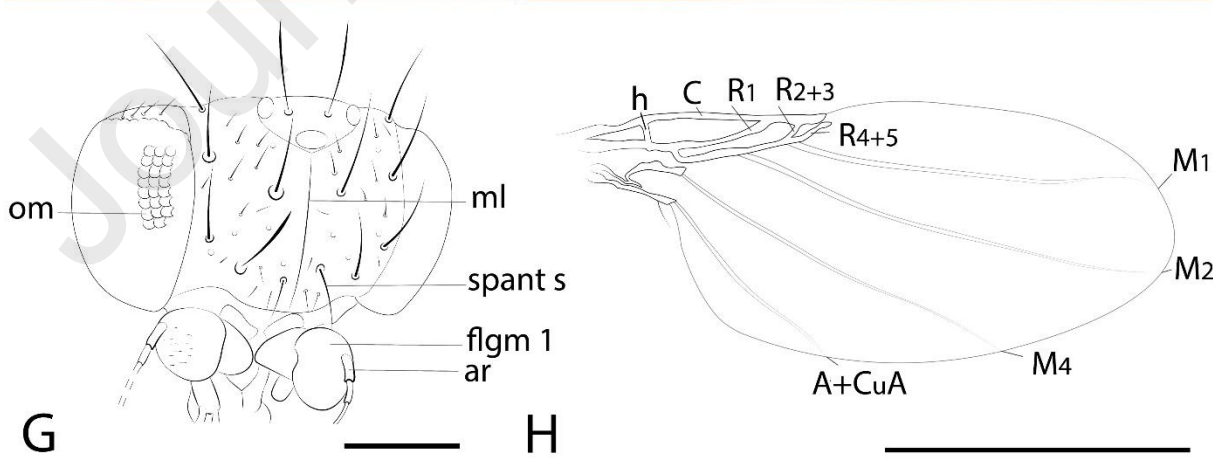
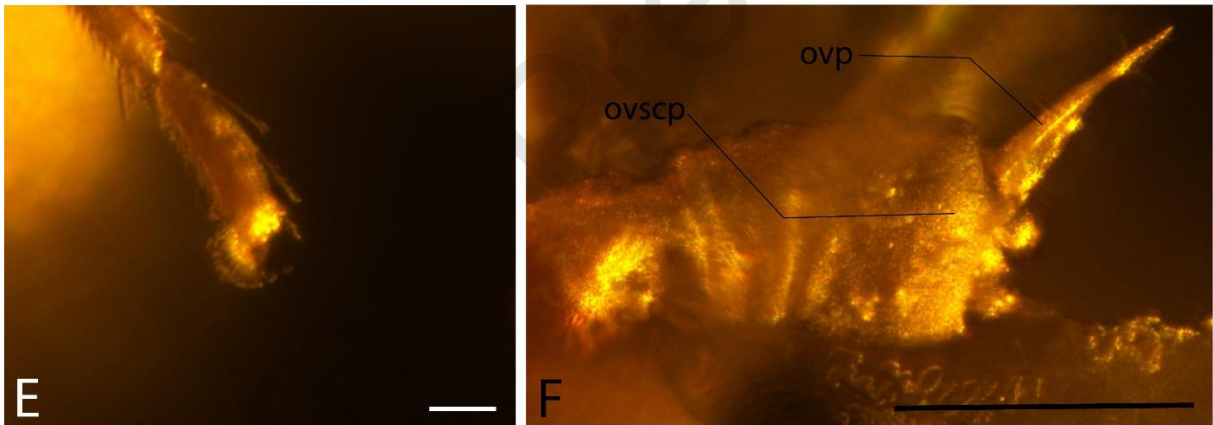
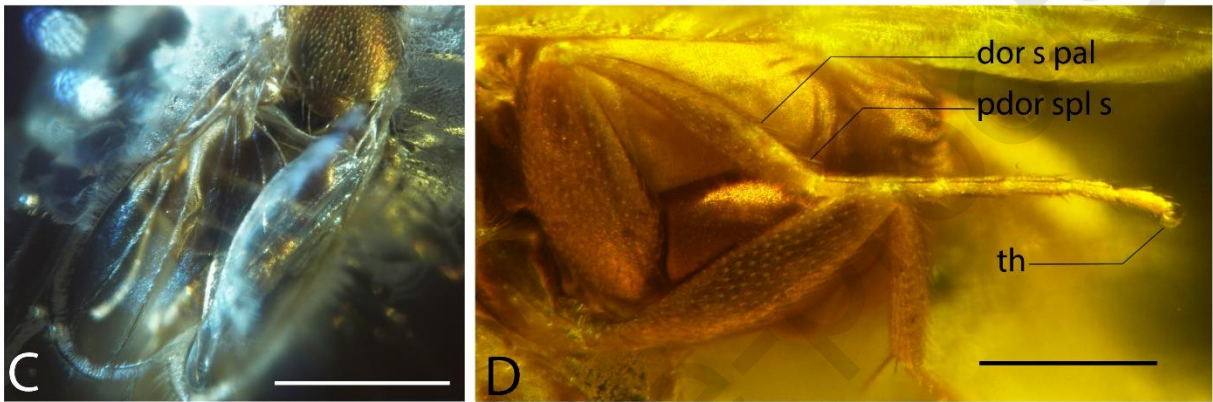
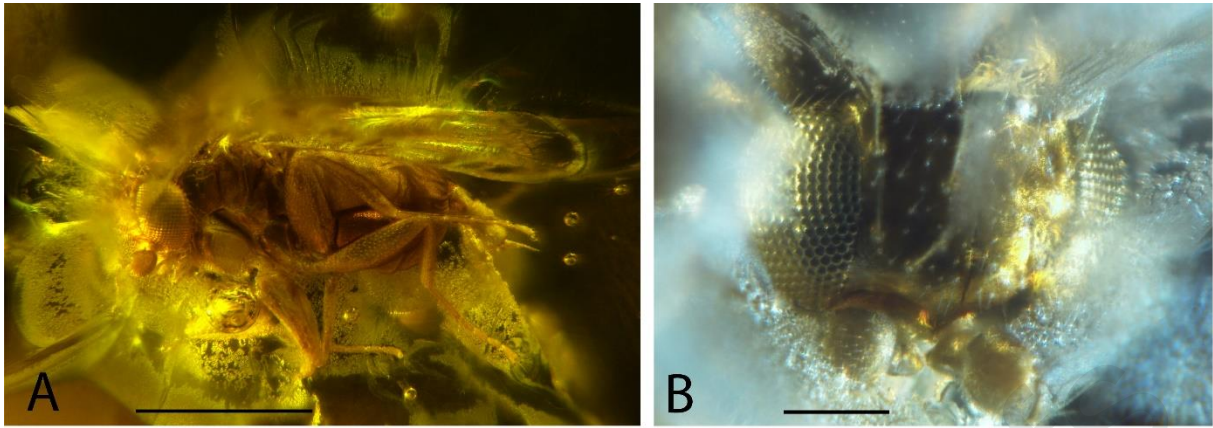

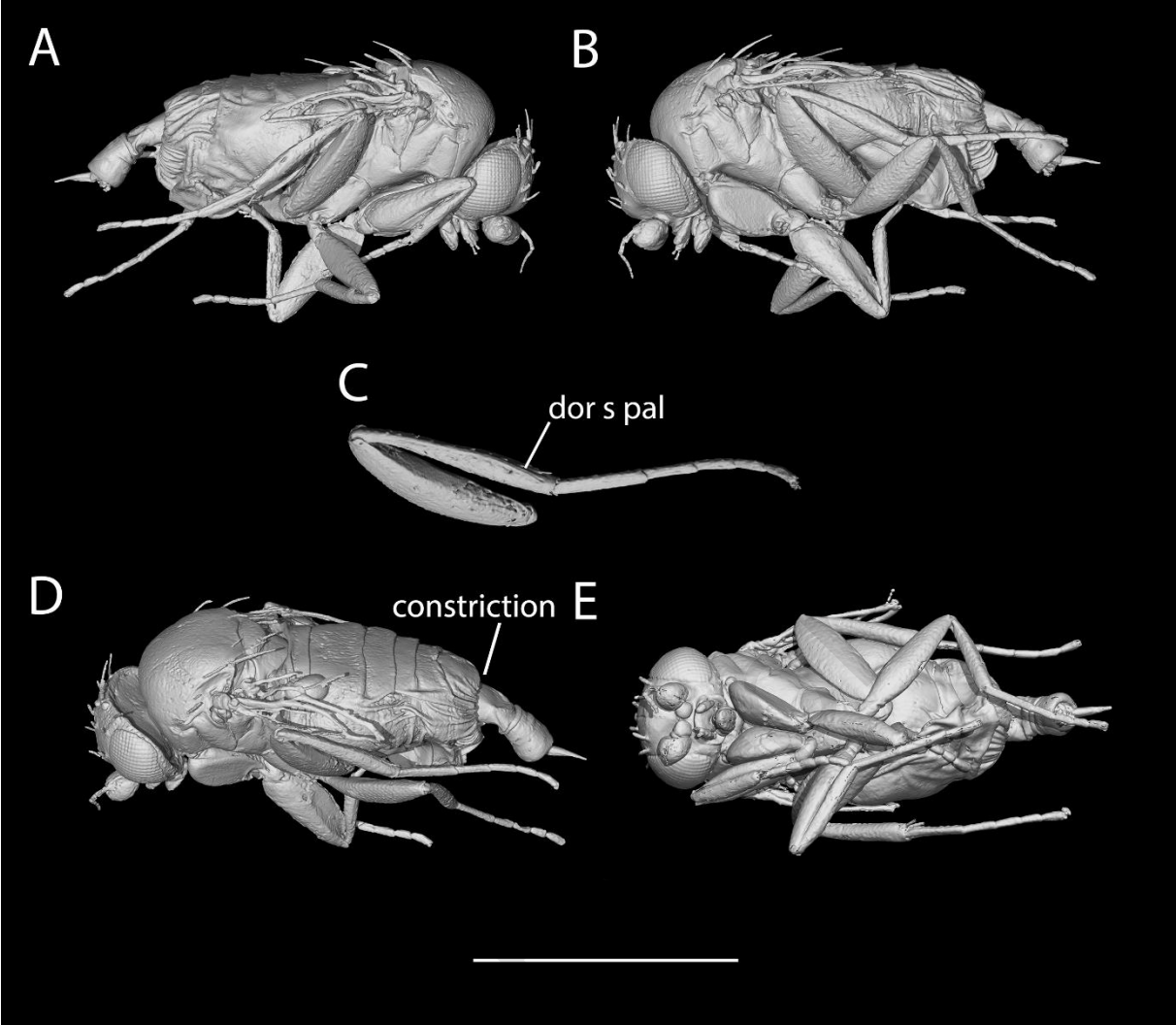

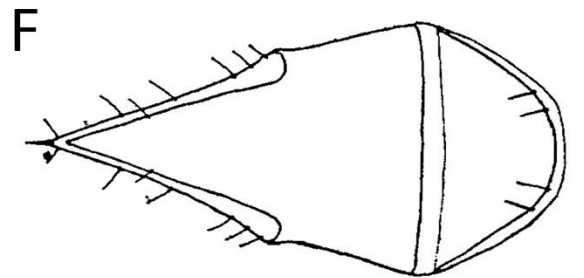
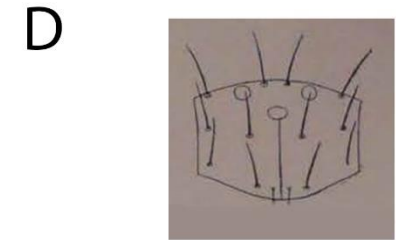
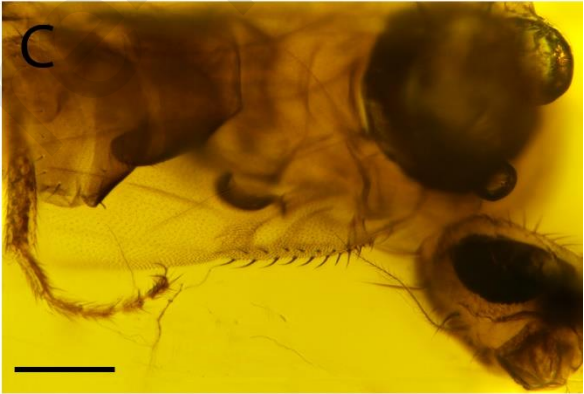
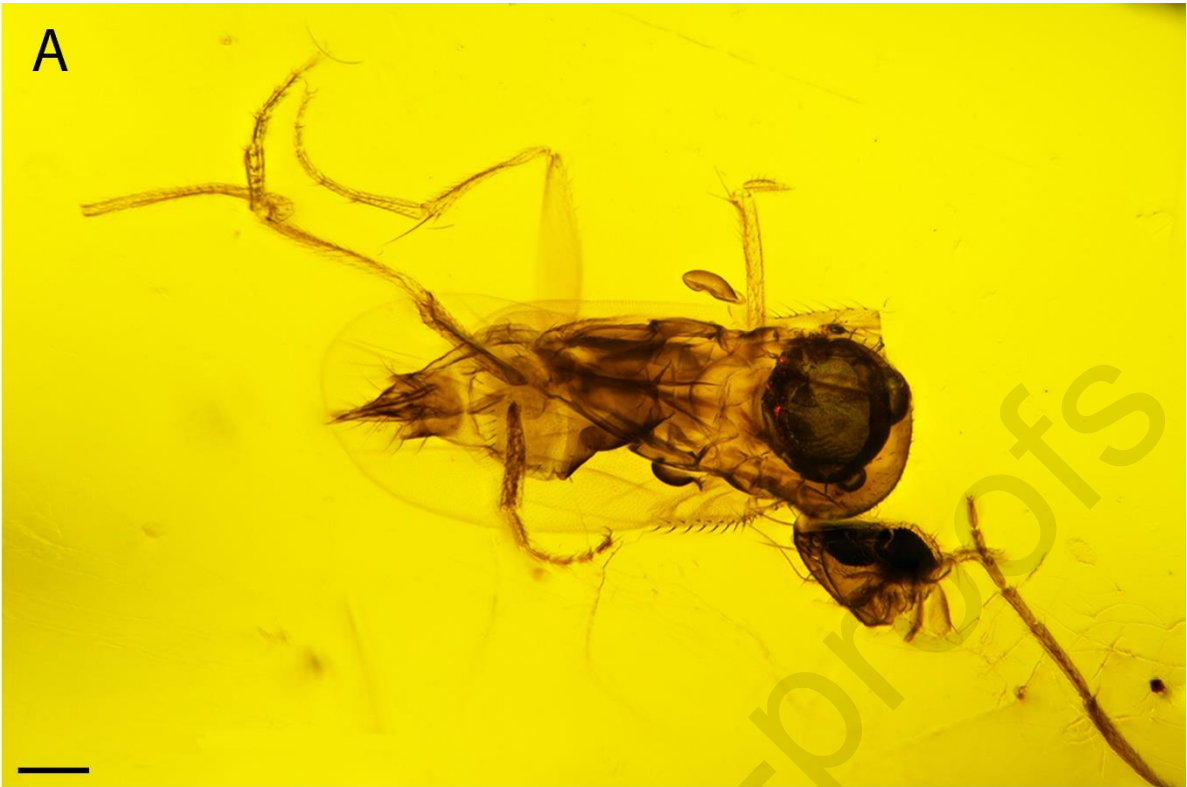

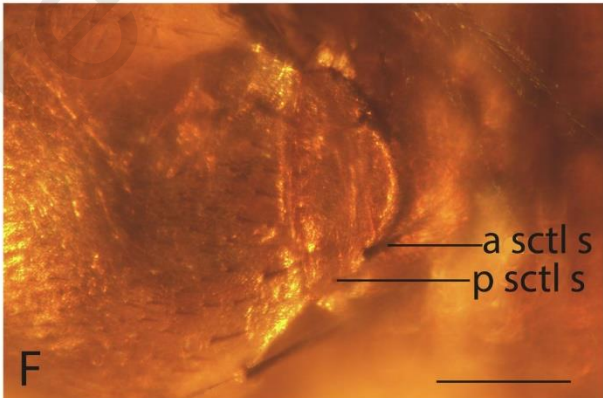
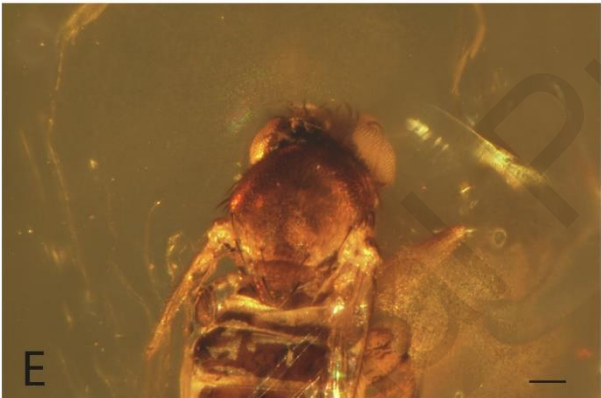
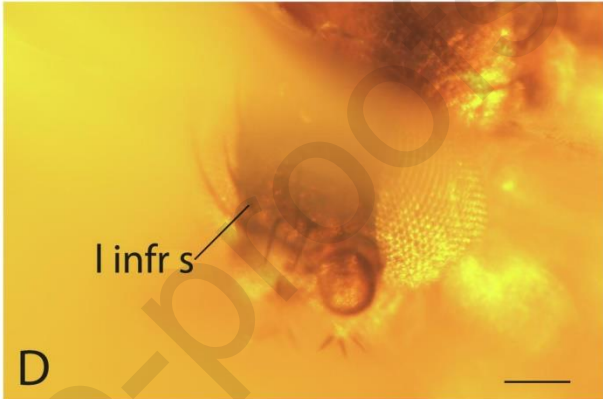
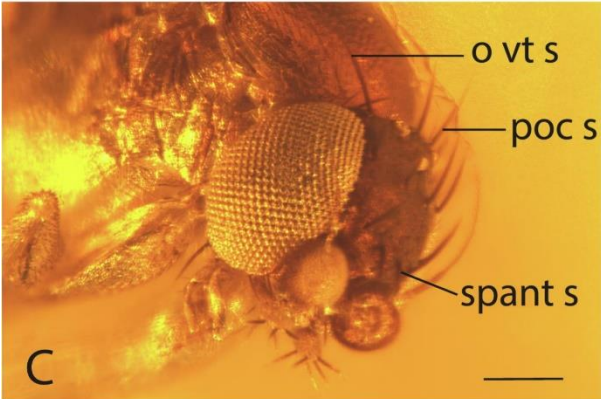

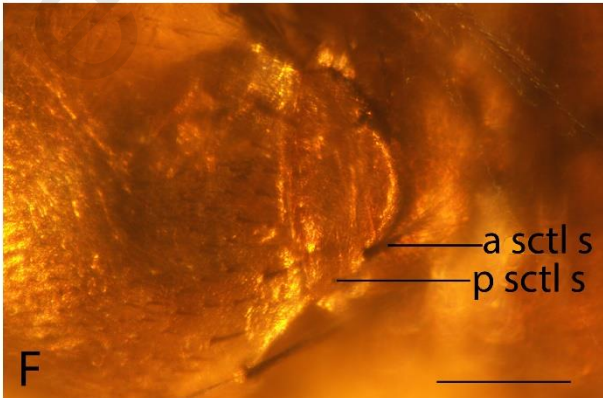
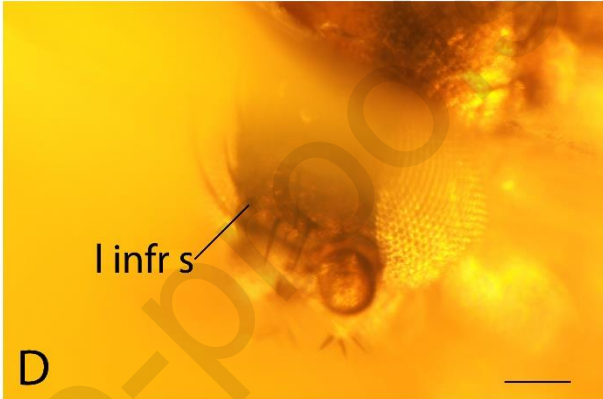

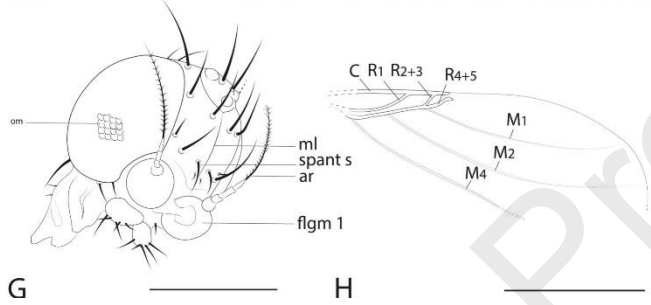
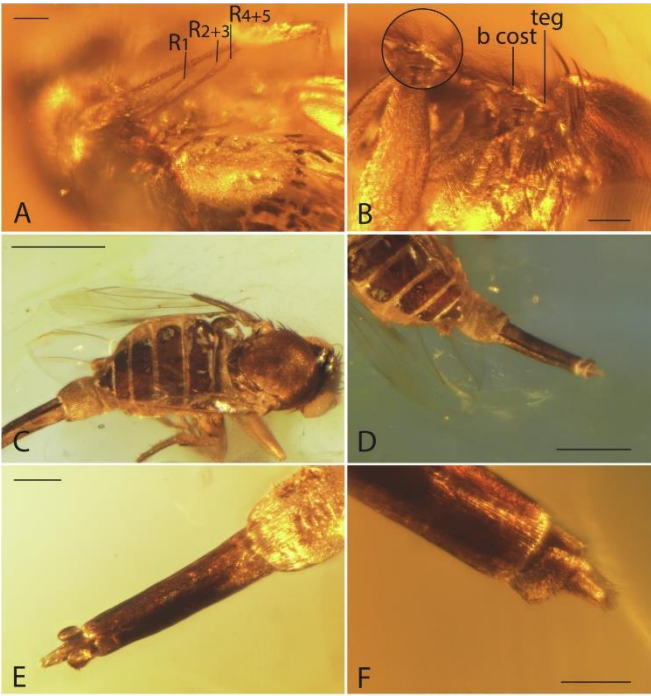

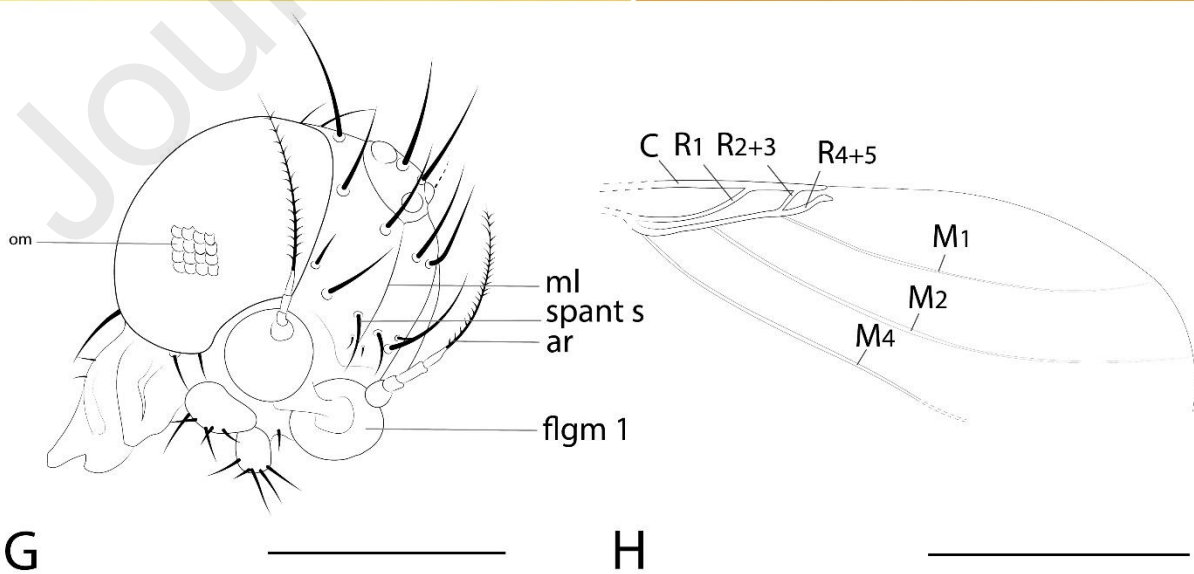
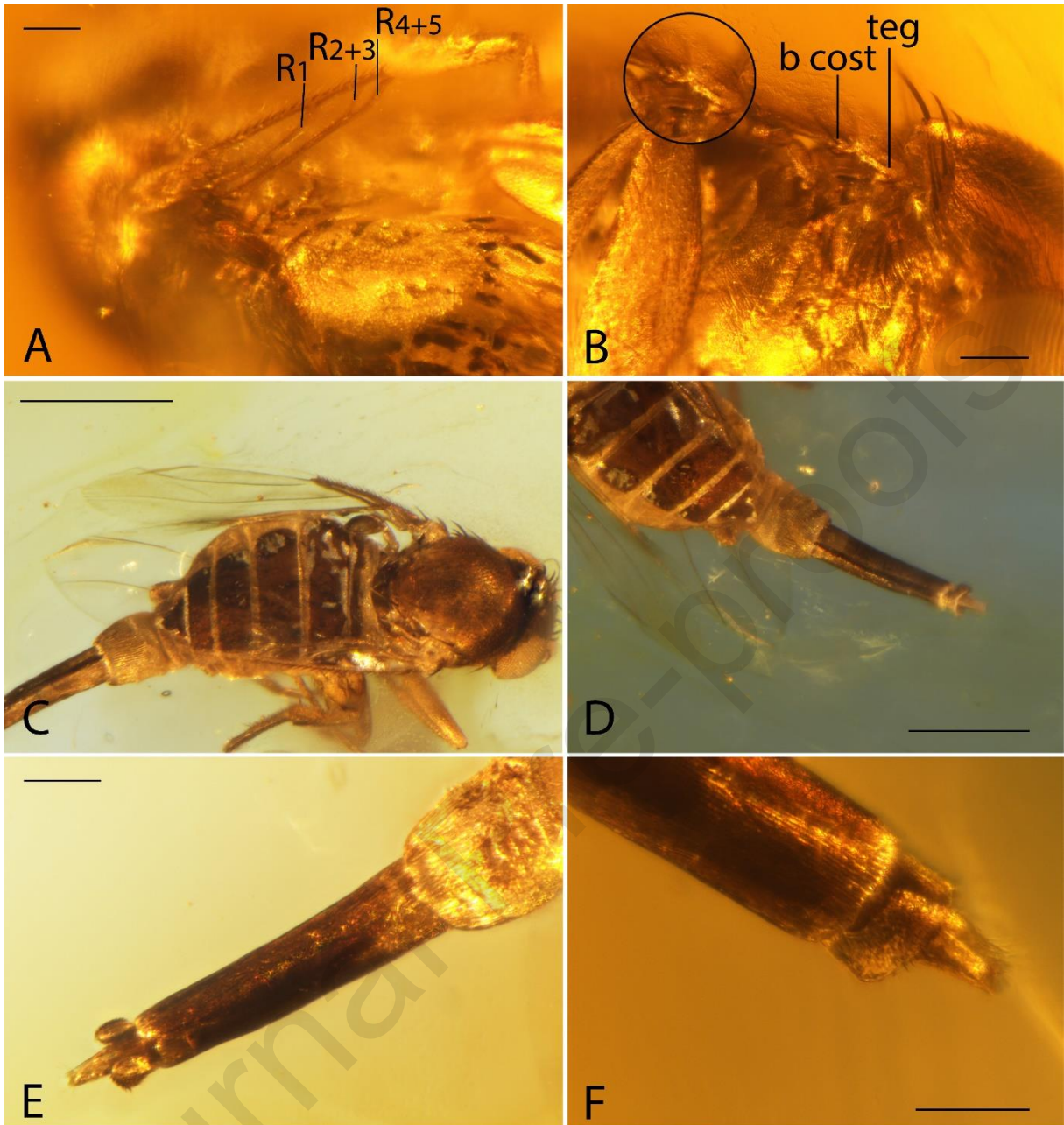

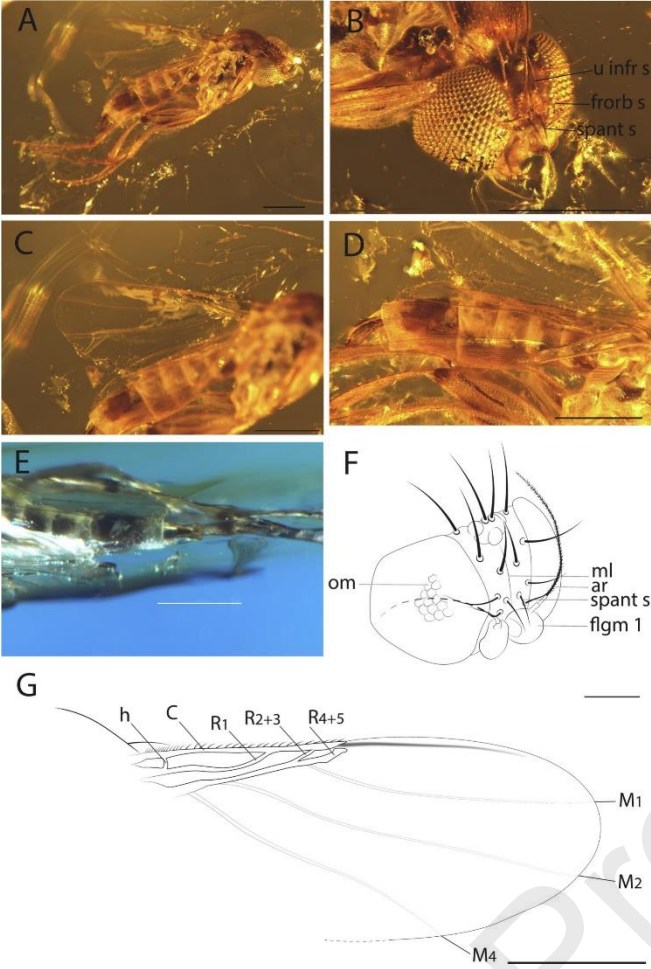

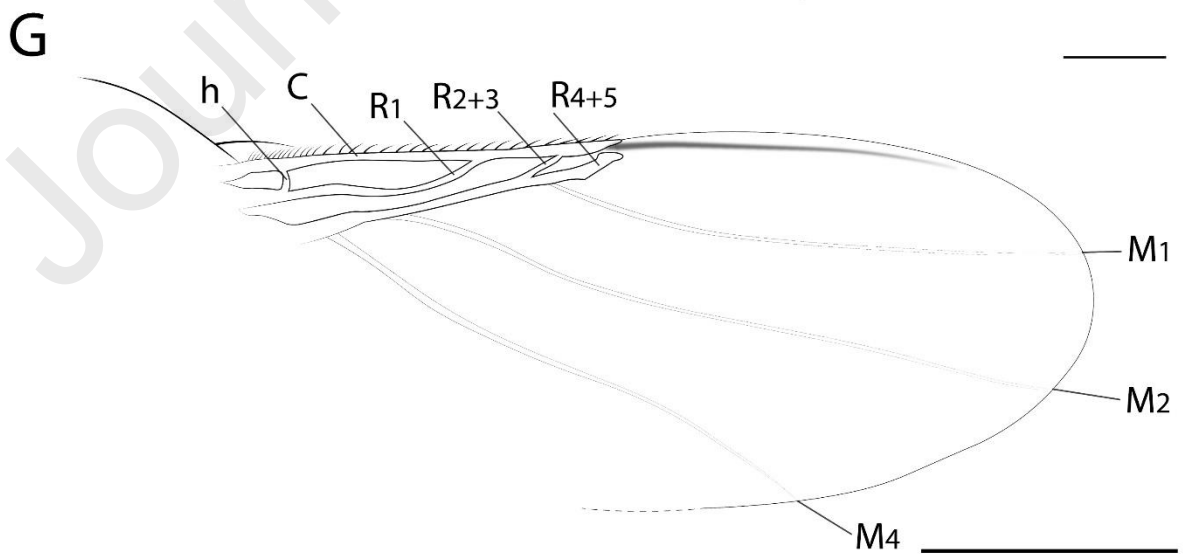
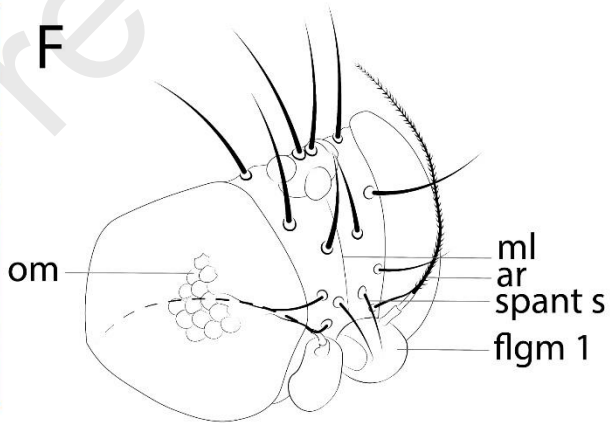
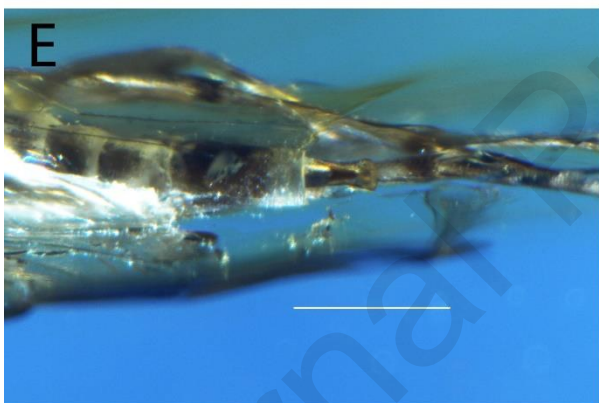
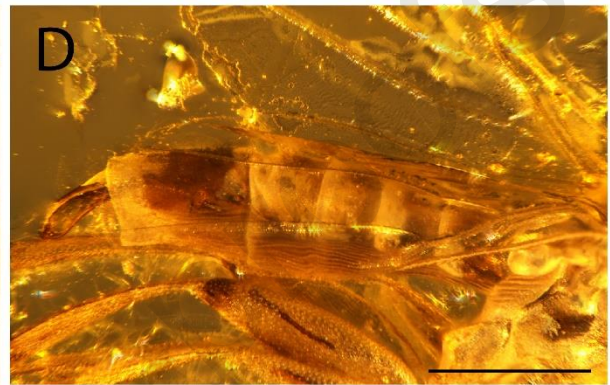
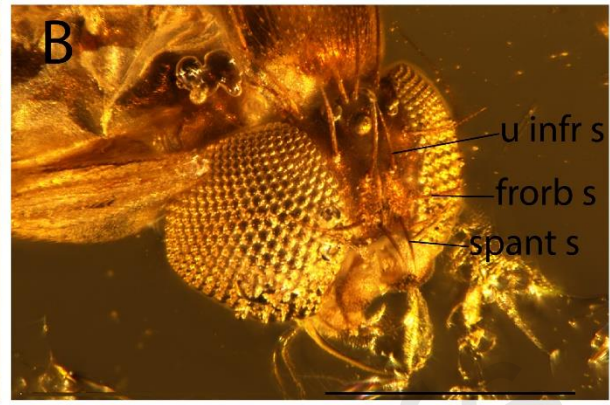

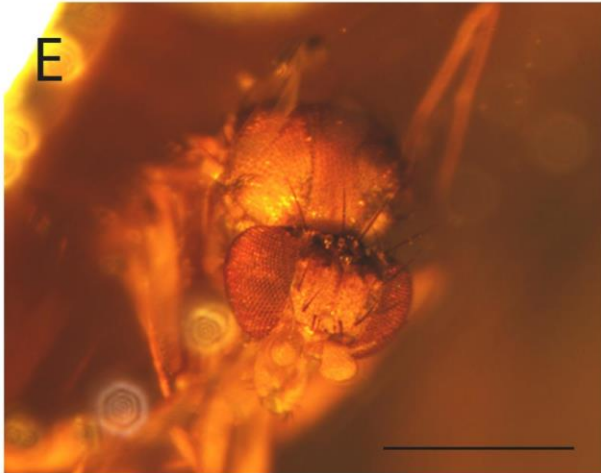
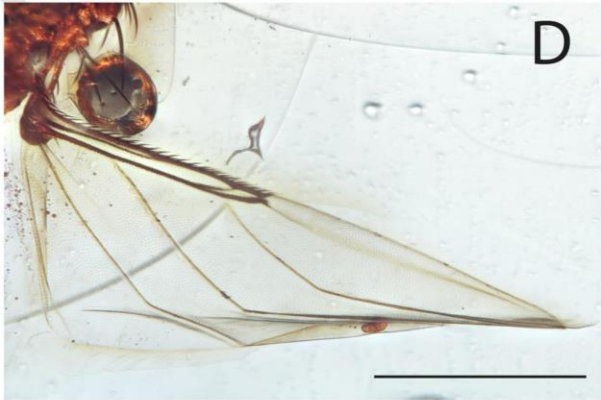

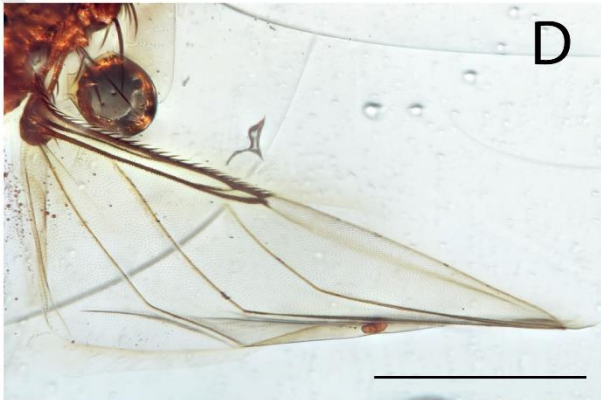

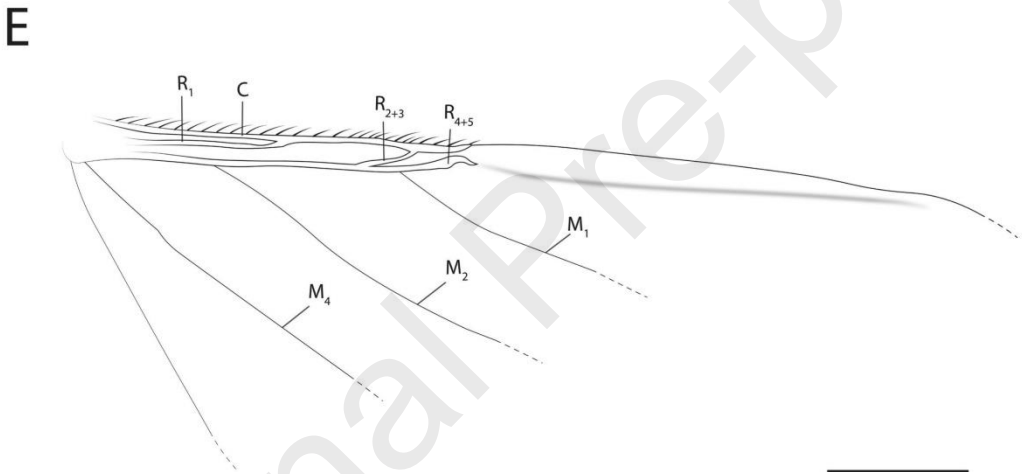
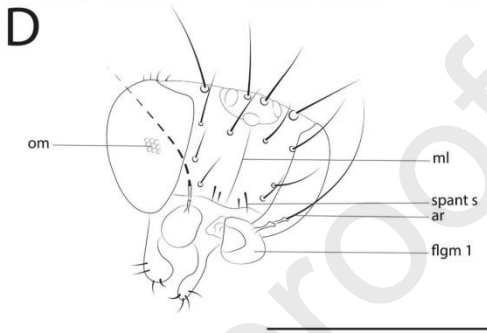
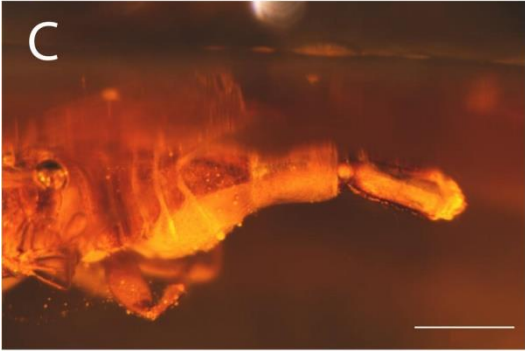
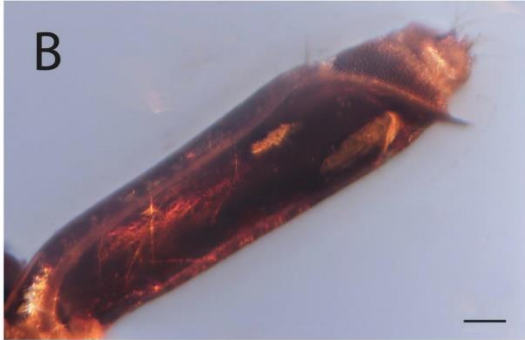

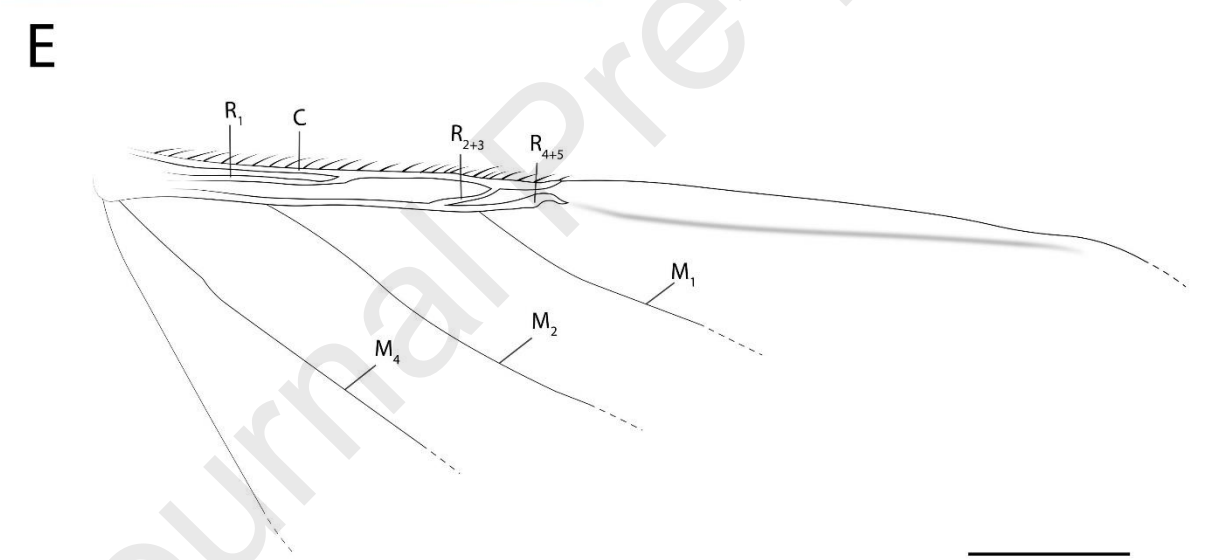
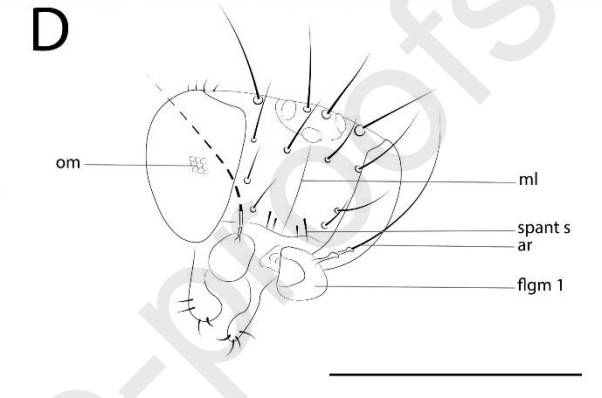
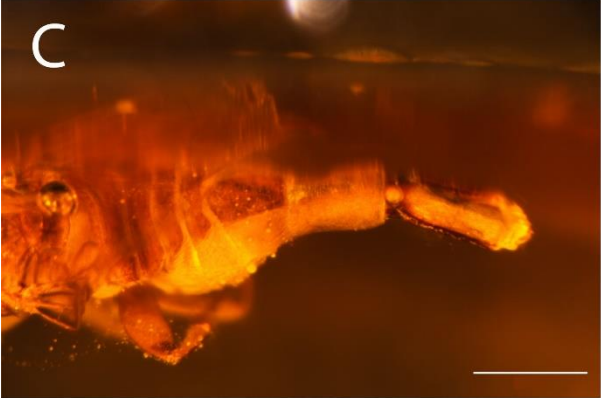
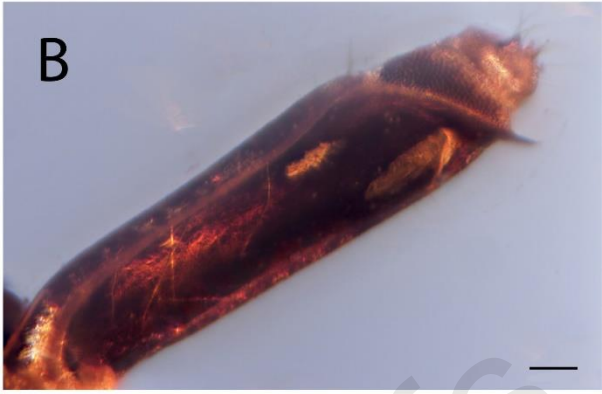

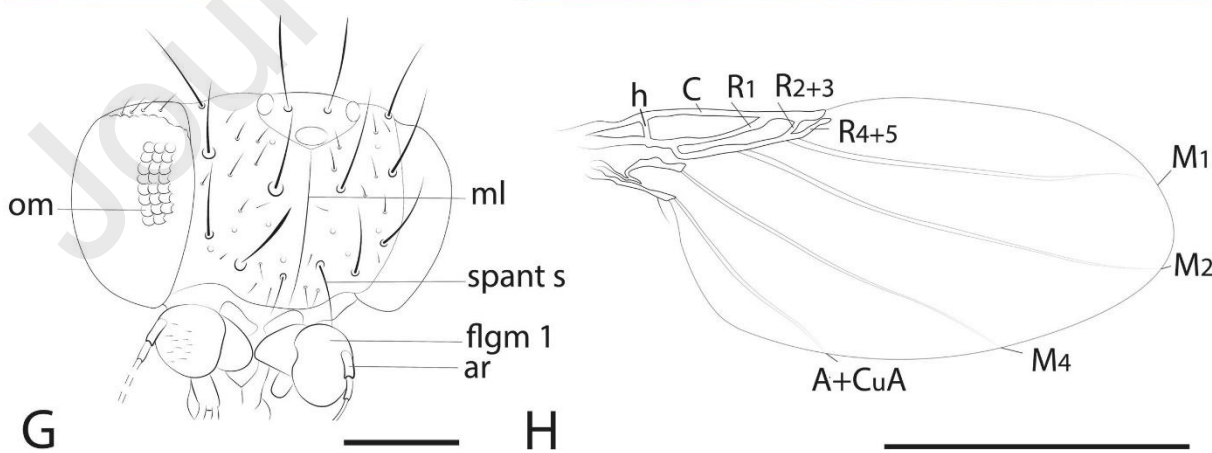
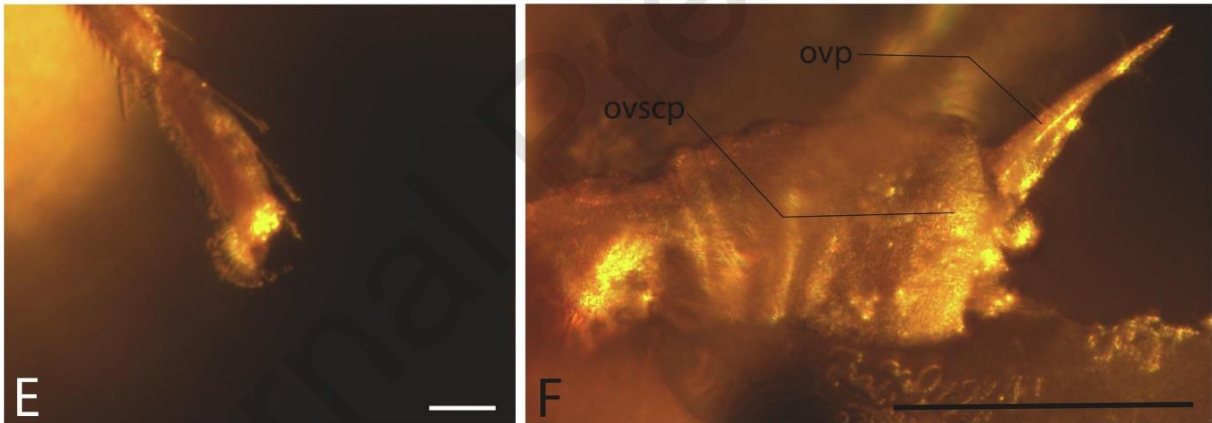
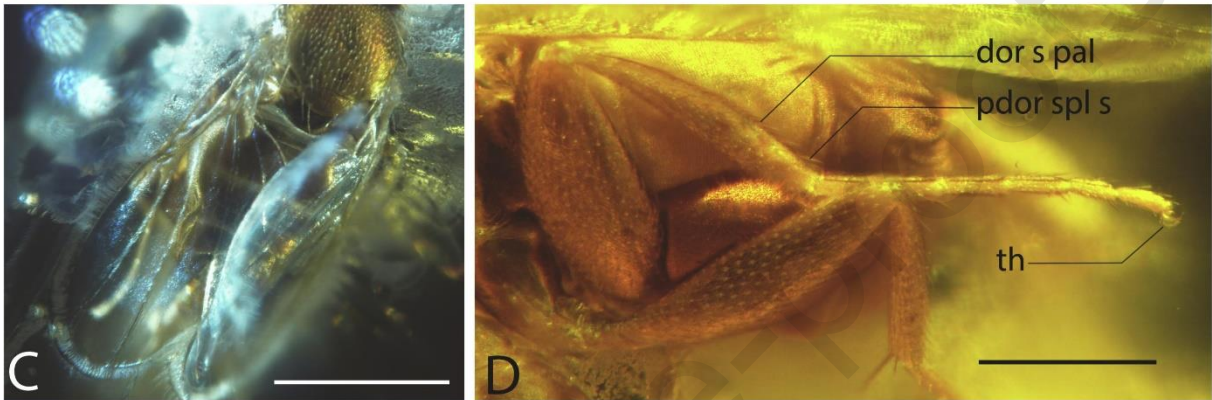
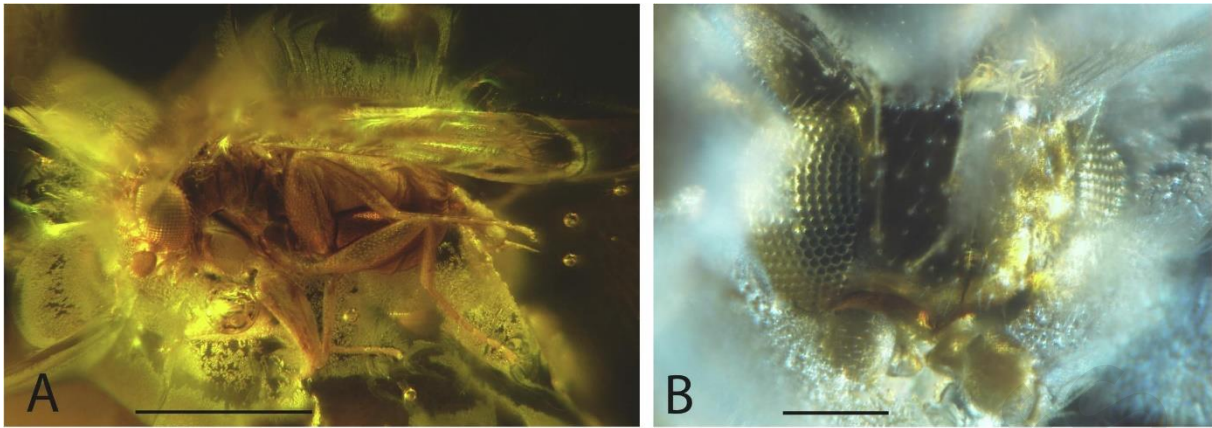

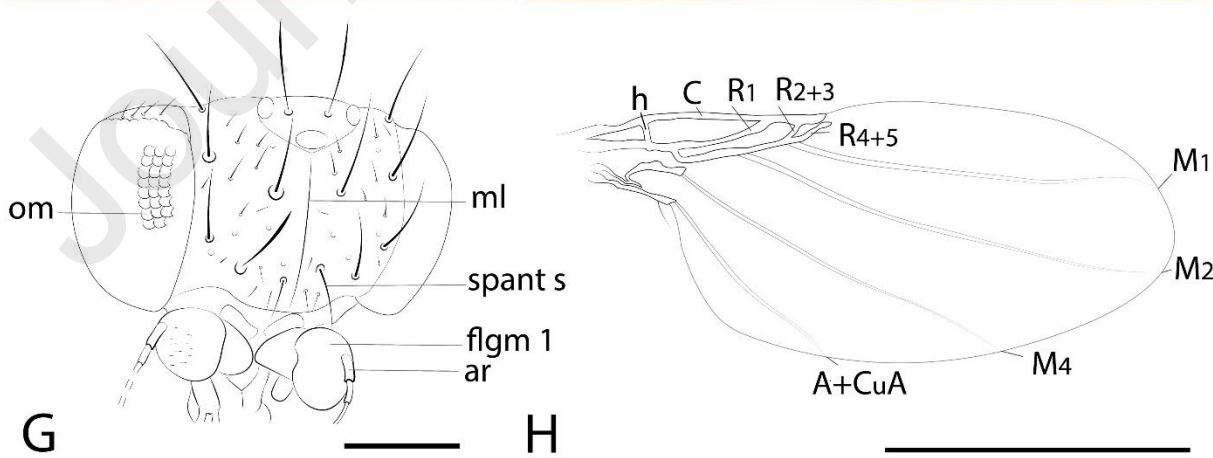
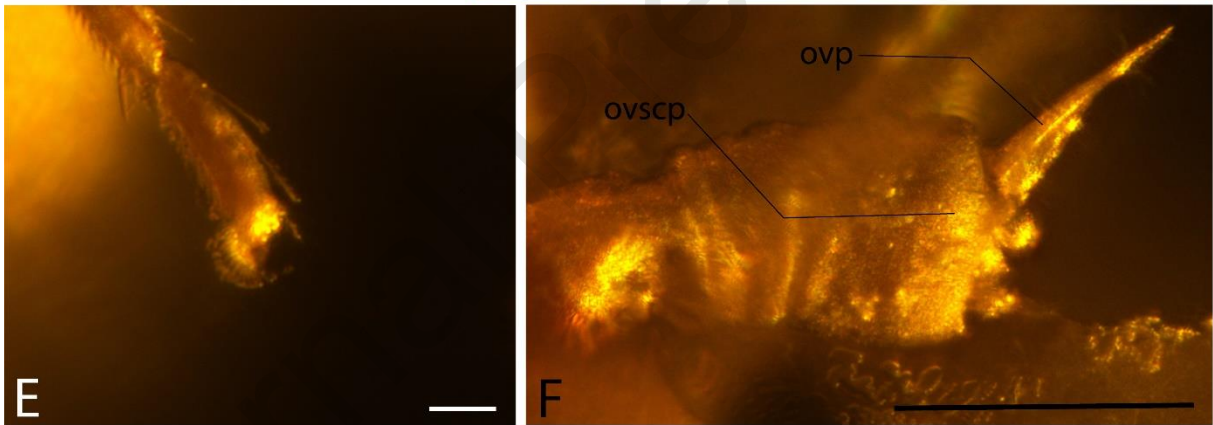
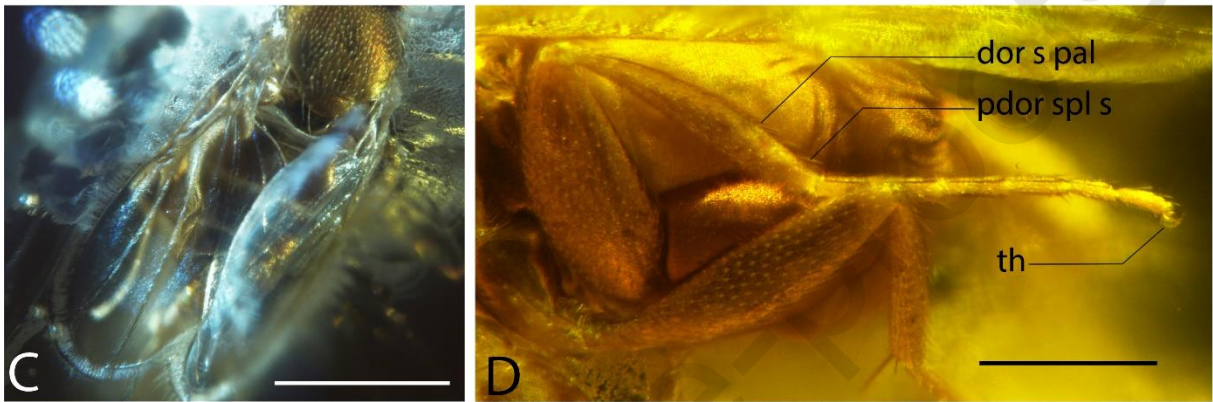
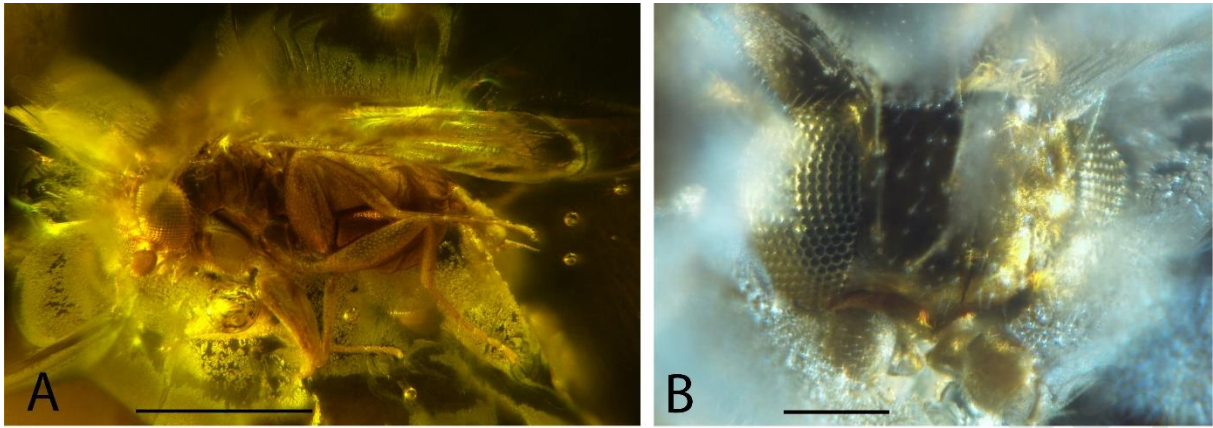

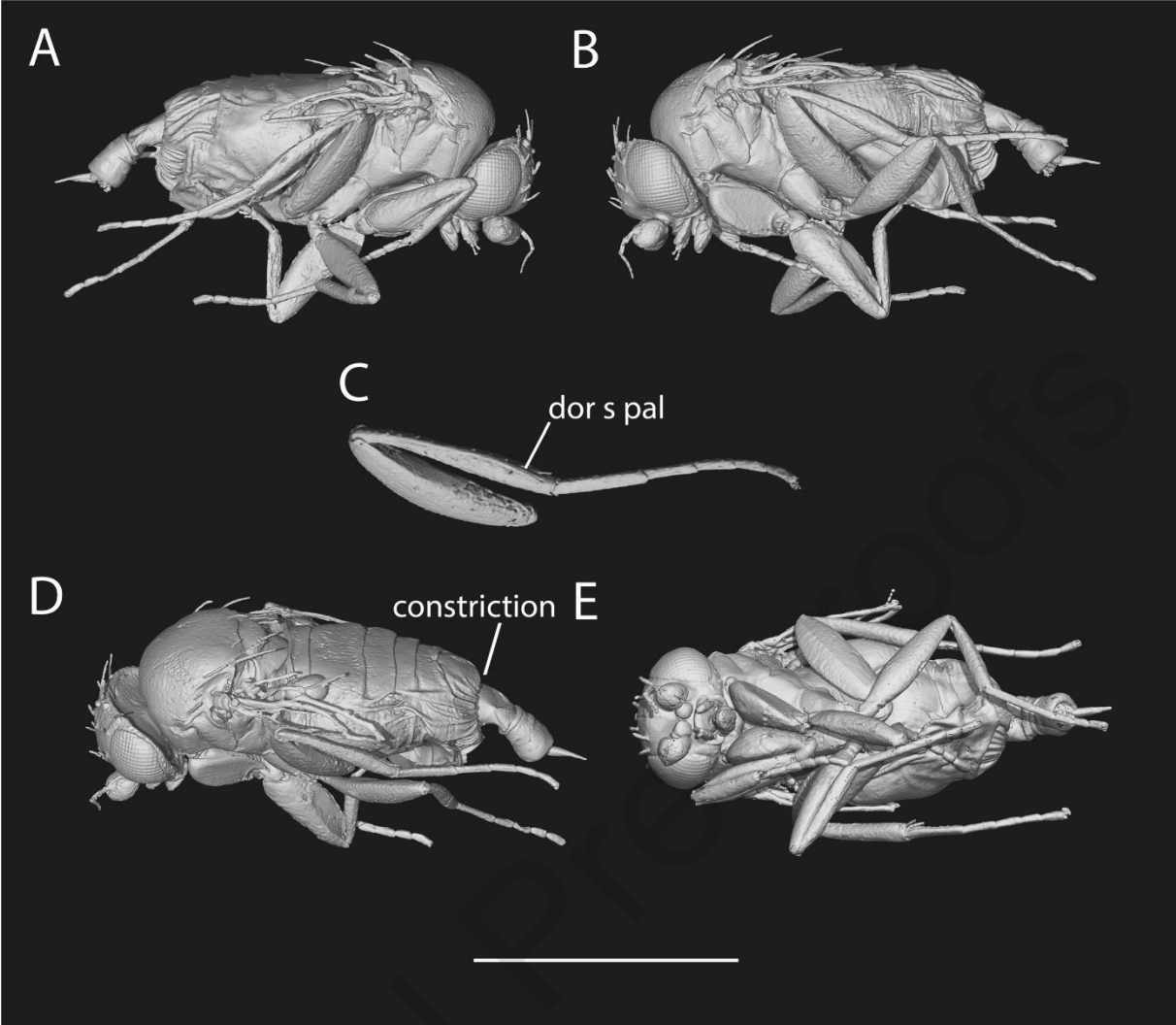

Journal

