



HAL
open science

Derivation of aerosol fluorescence and water vapor Raman depolarization ratios from lidar measurements

Igor Veselovskii, Qiaoyun Hu, Philippe Goloub, Thierry Podvin, William Boissiere, Mikhail Korenskiy, Nikita Kasianik, Sergey Khaykyn, Robin Miri

► To cite this version:

Igor Veselovskii, Qiaoyun Hu, Philippe Goloub, Thierry Podvin, William Boissiere, et al.. Derivation of aerosol fluorescence and water vapor Raman depolarization ratios from lidar measurements. Atmospheric Measurement Techniques Discussions, 2024, 10.5194/amt-2023-210 . insu-04255053v1

HAL Id: insu-04255053

<https://insu.hal.science/insu-04255053v1>

Submitted on 23 Oct 2023 (v1), last revised 13 Feb 2024 (v2)

HAL is a multi-disciplinary open access archive for the deposit and dissemination of scientific research documents, whether they are published or not. The documents may come from teaching and research institutions in France or abroad, or from public or private research centers.

L'archive ouverte pluridisciplinaire **HAL**, est destinée au dépôt et à la diffusion de documents scientifiques de niveau recherche, publiés ou non, émanant des établissements d'enseignement et de recherche français ou étrangers, des laboratoires publics ou privés.



Distributed under a Creative Commons Attribution 4.0 International License



1 **Derivation of aerosol fluorescence and water vapor Raman depolarization ratios from lidar**
2 **measurements**

3 Igor Veselovskii¹, Qiaoyun Hu², Philippe Goloub², Thierry Podvin², William Boissiere², Mikhail
4 Korenskiy¹, Nikita Kasianik¹, Sergey Khaykyn³, Robin Miri²

5
6 ¹*Prokhorov General Physics Institute of the Russian Academy of Sciences, Moscow, Russia.*

7 ²*Univ. Lille, CNRS, UMR 8518 - LOA - Laboratoire d'Optique Atmosphérique, F-59650 Lille,*
8 *France*

9 ³*Laboratoire Atmosphère Observations Spatiales, UVSQ, CNRS, Sorbonne University,*
10 *Guyancourt, France*

11 **Correspondence:** Qiaoyun Hu (qiaoyun.hu@univ-lille.fr)

12

13 **Abstract**

14 Polarization properties of the fluorescence induced by polarized laser radiation are widely
15 considered in laboratory studies. In lidar observations, however, only the total scattered power of
16 fluorescence is analyzed. In this paper we present results obtained with a modified Mie-Raman-
17 Fluorescence lidar operated at the ATOLL observatory, Laboratoire d'Optique Atmosphérique,
18 University of Lille, France, allowing to measure depolarization ratios of fluorescence at 466 nm
19 (δ_F) and of water vapor Raman backscatter. Measurements were performed in May-June 2023
20 during Alberta forest fires season when smoke plumes were almost continuously transported over
21 the Atlantic Ocean towards Europe. During the same period, smoke plumes from the same sources
22 were also detected and analyzed in Moscow, at General Physics Institute (GPI), with a 5-channel
23 fluorescence lidar able to measure fluorescence backscattering at 438, 472, 513, 560 and 614 nm.
24 Results demonstrate that, inside the boundary layer (BL), urban aerosol fluorescence is maximal
25 at 438 nm, then it gradually decreases with wavelength. Results also show that the maximum of
26 the smoke fluorescence spectrum shifted towards longer wavelengths. The smoke layers observed
27 within 4–6 km present a maximum of fluorescence at 513 nm while, in the upper troposphere (UT),
28 the maximum shifts to 560 nm. Regarding fluorescence depolarization, its value typically varies
29 inside the 45–55 % range, however several smoke plume layers detected above 10 km were
30 characterized by a δ_F increasing up to 70%. Inside the BL, the fluorescence depolarization ratio
31 was higher than that of smoke and varied inside the 50–70% range. Moreover, in the BL, δ_F appears



32 to vary with atmospheric relative humidity (RH) and, in contrast to the elastic scattering,
33 fluorescence depolarization increases with RH.

34 The depolarization ratio of the water vapor Raman backscattering is shown to be quite low
35 ($2\pm 0.5\%$) in the absence of fluorescence, because the narrowband interference filter in the water
36 vapor channel selects only strongest vibrational lines of the Raman spectrum. As a result,
37 depolarization of the water vapor Raman backscattering is sensitive to the presence of strongly
38 depolarized fluorescence backscattering. The fluorescence contamination into the water vapor
39 Raman channel can be calculated from the water vapor Raman depolarization ratio with the only
40 assumption that δ_F remains constant within the 408-466 nm range.

41

42 1. Introduction

43 Possibility to measure the laser induced fluorescence becomes an important added-value to
44 existing Mie-Raman lidars, because fluorescence measurements provide new independent
45 information about aerosol properties. Nowadays, the spectroscopic lidars based on 32-channel
46 PMT combined with spectrograph proved the ability to measure the fluorescence spectrum
47 (Sugimoto et al., 2012; Reichardt, 2014; Reichardt et al., 2018, 2023, Liu et al., 2022). On the
48 other hand, the lidars, with a single fluorescence channel can be widespread due to their simplicity
49 (Rao et al., 2018; Veselovskii et al., 2020). Such single channel fluorescence measurements
50 combined with depolarization measurements at elastic wavelength, provide new independent
51 information about aerosol type (Veselovskii et al., 2022; Wang et al., 2023). However, in all lidar
52 studies, only total scattered power was analyzed, while polarization properties of the fluorescence
53 were ignored. At the same time, fluorescence depolarization measurements are widely used in
54 laboratory research (Lakowicz, 2006). When polarized laser radiation is used for excitation, the
55 fluorescence emission is also partly polarized and degree of emission polarization (anisotropy)
56 depends on the fluorescence lifetime, on the angle between excitation and emission dipoles, and
57 on the rotational mobility of molecules (Lakowicz, 2006). In fluorescence spectroscopy the
58 anisotropy is introduced as given by Eq.1:

$$59 \quad r = \frac{P_F^{\parallel} - P_F^{\perp}}{P_F^{\parallel} + 2P_F^{\perp}} \quad (1)$$

60 Here P_F^{\parallel} and P_F^{\perp} are the powers of co- and cross-polarized fluorescence components. In lidar
61 measurements, however, a commonly used parameter is the depolarization ratio, δ_F .



62
$$\delta_F = \frac{P_F^\perp}{P_F^\parallel} \quad (2)$$

63 Anisotropy and depolarization ratio are two interconvertible parameters

64
$$r = \frac{1 - \delta_F}{1 + 2\delta_F} \quad (3)$$

65 For randomly oriented fluorophores with collinear absorption and emission dipoles, in the
66 absence of rotational motion, the anisotropy is $r=0.4$ (Lakowicz, 2006), which corresponds to
67 $\delta_F=33\%$. This is the minimal value one can expect in lidar measurements. Existence of the angle
68 between absorption and emission dipoles, as well as molecule rotation in the process of emission
69 will increase δ_F . Thus, measurement of fluorescence depolarization ratio may bring additional
70 information about atmospheric aerosol. Moreover, depolarization measurements help to analyze
71 the impact of fluorescence on water vapor Raman measurements.

72 Water vapor is a key atmospheric component playing essential role in the planet's radiative
73 balance, and Raman lidars today are widely used for vapor observations (Whiteman, 2003, Chouza
74 et al., 2022 and references therein). However, when the UV laser beam passes through a smoke
75 layer, the broadband fluorescence signal is induced and its spectrum includes the region of water
76 vapor Raman lines. Thus, the signal in the water vapor channel (around 407.5 nm, when 354.7 nm
77 radiation is used for stimulation) becomes contaminated by the fluorescence backscatter signal
78 (Immler et al., 2005; Immler and Schrems, 2005). This contamination can be reduced by
79 decreasing the width of the transmission band in the water vapor channel down to tenths of nm.
80 However, as it was shown recently, fluorescence still remains the issue, especially inside the smoke
81 layers in high troposphere (Chouza et al., 2022; Reichardt et al., 2023).

82 Depolarization measurements provide an opportunity to monitor the presence of
83 fluorescence signal in Raman channel. The Q-branch of water vapor Raman lines (near 407.5 nm)
84 provides a weakly depolarized backscatter, while fluorescence is strongly depolarized. Thus the
85 presence of fluorescence should increase the depolarization ratio of signal in the water vapor
86 channel. Moreover, if depolarization ratios of water vapor and fluorescence are known, the
87 contribution of fluorescence to the measured water vapor mixing ratio (WVMR) can be evaluated.

88 In this article, report and analyze, for the first time, depolarization ratio of aerosol
89 fluorescence and depolarization ratio of water vapor Raman backscatter from lidar observations
90 performed at the ATOLL observatory (ATmospheric Observation at liLLe), Laboratoire



91 d'Optique Atmosphérique, University of Lille, during dense smoke events that occurred in May -
92 June 2023. We start with a description of the experimental setup in Sect.2.1 and derive, in Sect.
93 2.2, the main equations for estimating the fluorescence contribution to the water vapor Raman
94 channel. In the first part of the results section (Sect.3.1), the fluorescence depolarization ratio over
95 ATOLL is analyzed for different aerosol types. The measurements of fluorescence spectra
96 performed with a new five-channel fluorescence lidar, operated in Moscow, are presented in
97 Sect.3.2. In Sect. 3.3, we analyze depolarization in the water vapor Raman channel and estimate
98 the contamination of fluorescence to the derived WVMR. The article ended with a conclusion.

99

100 **2. Experimental setup and data analysis**

101 **2.1 Lidar system**

102 In our study, two lidar systems were considered. The first one, LILAS ((Lille Lidar
103 AtmosphereS) is a multiwavelength Mie-Raman-Fluorescence lidar, whereas the second one is a
104 multiwavelength fluorescence lidar operated by General Physics Institute (GPI), Moscow (Veselovskii
105 et al., 2023). Both systems are based on a tripled Nd:YAG laser (Q-Smart 450) with a 20 Hz
106 repetition rate and pulse energy about 100 mJ at 355 nm. Backscattered light in both systems is
107 collected by a 40 cm aperture telescope and the lidar signals are digitized with Licel transient
108 recorders with 7.5 m range resolution, allowing simultaneous detection in the analog and photon
109 counting mode.

110 LILAS allows the so called $3\beta+2\alpha+3\delta$ configuration, including three particle
111 backscattering (β_{355} , β_{532} , β_{1064}), two extinction (α_{355} , α_{532}) coefficients along with three particle
112 depolarization ratios. The Raman channel with 407.54/0.3 nm interference filter allows also water
113 vapor profiling. At the end 2019, the lidar was modified to enable fluorescence measurements. A
114 part of the fluorescence spectrum is selected by a wideband interference filter of 44 nm width
115 centered at 466 nm (Veselovskii et al. 2020).

116 In the fluorescence lidar of GPI only 355 nm wavelength is emitted, while fluorescence is
117 measured in five spectral intervals. The central wavelengths and widths of transmission bands are:
118 438(29), 472(32), 513(29), 560(40) and 614(54) nm (Veselovskii et al., 2023). Thus, the
119 fluorescence spectrum could be sampled. At GPI, the measurements were performed at an angle
120 of 48 deg to the horizon. The strong sunlight background restricts the fluorescence observations
121 of both systems to nighttime hours.



122 Several properties can be derived from fluorescence. The fluorescence backscattering
123 coefficient, $\beta_{F\lambda}$, at wavelength λ_F , is calculated from the ratio of fluorescence and nitrogen Raman
124 backscattering signals, as described in Veselovskii et al. (2020). We remind that $\beta_{F\lambda}$ is related to
125 fluorescence signals integrated over the filter transmission band D_λ . In Moscow measurements are
126 performed at five wavelengths, and to compare $\beta_{F\lambda}$ between different channels one makes use of
127 the “fluorescence spectral backscattering coefficient” $B_\lambda = \frac{\beta_{F\lambda}}{D_\lambda}$ (fluorescence backscattering per
128 spectral interval). LILAS has only one single fluorescence channel, therefore, when presenting
129 data from LILAS, for the sake of simplicity, one uses notation $\beta_{F466} = \beta_F$. The intensive property
130 characterizing aerosol fluorescence is the fluorescence capacity $G_{F\lambda}$, which is the ratio of the
131 fluorescence backscattering at wavelength λ_F to backscattering coefficient at laser wavelength
132 $G_{F\lambda} = \frac{\beta_F}{\beta_\lambda}$. This ratio, in principle, can be calculated for any laser wavelength. For LILAS
133 observations $G_{F\lambda}$ is calculated with respect to β_{532} , because β_{532} is derived with rotational Raman
134 scattering and is considered to be the most reliable. And again, when presenting LILAS data, for
135 simplicity one will use notation $G_{F\lambda} = G_F$. In this work, all profiles of aerosol properties are
136 smoothed with the Savitzky – Golay method, using second order polynomials with 8 points in the
137 window.

138 Additional information about the atmospheric thermodynamic state was available from
139 radiosonde measurements performed at Herstmonceux (UK) and Beauvechain (Belgium) stations,
140 located 160 km and 80 km away from the ATOLL observatory respectively. When calculating the
141 relative humidity, one then used the water vapor profiles measured by Raman lidar and temperature
142 profiles provided by the radiosonde.

143 As discussed in the introduction, measurements of fluorescence depolarization ratio and
144 depolarization of water vapor Raman backscatter are expected to bring new information about
145 aerosol properties and fluorescence contamination in the water vapor Raman channel. In 2023,
146 LILAS was upgraded to allow depolarization measurements at both 466 nm and 408 nm.
147 Corresponding optical layout is shown in Fig.1. Dichroic mirrors DM separate 387, 408 and 466
148 nm components, while polarizing cubes split the components with polarizations oriented parallel
149 (s) and perpendicular (p) to the laser polarization. For both channels the polarizing cube PBS251
150 from ThorLabs was used. Fluorescence depolarization ratio, δ_F , and water vapor Raman scattering



151 depolarisation ratio, δ_w , are both defined and calculated as a ratio of the perpendicular to the
152 parallel respective components. Calibration was performed as described in Freudenthaler et al.
153 (2009). The uncertainty of calibration is estimated to be below 15% for both 466 and 408 nm
154 channels.

155

156 **2.2 Expressions for estimating fluorescence impact on water vapor measurements.**

157 As discussed in the recent work from Chouza et al. (2022) and Reichardt et al. (2023), the
158 broadband aerosol fluorescence is expected to contribute to the signal measured in water vapor
159 Raman channel. Below, one provides the basic equations for estimating this contribution, based
160 on the measurements of the depolarization ratio in the water vapor Raman channel. The
161 backscattered radiative power, at the laser wavelength λ_L , from distance z , can be modeled, after
162 background subtraction, by

$$163 \quad P_L = O(z) \frac{1}{z^2} C_L \beta T_L^2 \quad (4)$$

164 Here $O(z)$ is the geometrical overlap factor, which is assumed to be the same for all channels. C_L
165 is the range independent constant, including efficiency of the detection channel. T_L is one-way
166 transmission, describing light losses on the way from the lidar to distance z at wavelength λ_L .

$$167 \quad T_L = \exp \left\{ - \int_0^z [\alpha^a(\lambda_L, z') + \alpha^m(\lambda_L, z')] dz' \right\} \quad (5)$$

168 Backscattering and extinction coefficients contain aerosol (a) and molecular (m) contributions:

$$169 \quad \beta_{\lambda_L} = \beta_{\lambda_L}^a + \beta_{\lambda_L}^m \quad \text{and} \quad \alpha_{\lambda_L} = \alpha_{\lambda_L}^a + \alpha_{\lambda_L}^m.$$

170 Radiative power in nitrogen Raman, water vapor Raman, and fluorescence channels can be
171 written in a similar way.

$$172 \quad P_R = O(z) \frac{1}{z^2} C_R \sigma_R N_R T_L T_R \quad (6)$$

$$173 \quad P_W = O(z) \frac{1}{z^2} C_W N_W \sigma_W T_W T_L \quad (7)$$

$$174 \quad P_F = O(z) \frac{1}{z^2} C_F \beta_F T_F T_L \quad (8)$$

175 Here C_R , C_W , C_F are the corresponding range independent constants. Terms T_R , T_V , and T_F are one-
176 way transmissions at wavelengths λ_R , λ_W , λ_F , corresponding to the centers of transmission bands of



177 the channels. Terms N_R and N_W are the concentrations in nitrogen and water vapor molecules while
178 σ_R , σ_W are their Raman differential scattering cross sections respectively. The fluorescence
179 backscattering coefficient, β_F , is introduced the same way, as described in (Veselovskii et al.,
180 2020).

181 The power of fluorescence signal that leaks to the water vapor channel is:

$$182 \quad P_{FW} = O(z) \frac{1}{z^2} C_W \beta_{FW} T_W T_L \quad (9)$$

183 Here β_{FW} is fluorescence backscattering at wavelength λ_W . The WVMR, n_W , can be obtained from

184 Eq.6 and Eq.7, if the calibration constant $K_W = \frac{C_R \sigma_R}{C_W \sigma_W}$ is known and is given by Eq. 10

$$185 \quad n_W = K_W \frac{P_W T_R}{P_R T_W} \quad (10)$$

186 The fluorescence backscattering coefficient, β_F , derived from Eq.6 and Eq.8, also contains
187 the calibration constant K_F . The procedure of calibration is described in Veselovskii et al. (2020).
188 Finally, β_F is given by Eq. 11.

$$189 \quad \beta_F = K_F n_R \frac{P_F T_R}{P_R T_F} \quad (11)$$

190 Here $n_R = \frac{N_R(z)}{N_R(z=0)}$ is relative change of number density of nitrogen molecules with height.

191 The fluorescence signal in the water vapor channel can be expressed from P_F using parameter η ,
192 which depends on ratio of fluorescence cross sections at wavelengths λ_W and λ_F , on the filters
193 width and on efficiency of both channels.

$$194 \quad P_{FW} = P_F \eta \frac{T_W}{T_F} \quad (12)$$

195 The signal measured in the water vapor channel, \tilde{P}_W , is the addition of both water vapor
196 backscatter, P_W , and the fluorescence backscatter, P_{FW} ,

$$197 \quad \tilde{P}_W = P_W + P_{FW} = P_W + P_F \eta \frac{T_W}{T_F} \quad (13)$$

198 One should remember, that the fluorescence spectrum, even for the same type of aerosol, can vary
199 with altitude and from observation to observation, which influences η . To minimize this influence
200 it is desirable to keep λ_W and λ_F as close as possible.



201 If the signals in the water vapor Raman and fluorescence channels are separated into co-
 202 polarized ($||$) and cross-polarized (\perp) components, in respect to laser polarization state, their
 203 powers in water vapor Raman channel are given respectively by Eq. 14 and Eq. 15

$$204 \quad \tilde{P}_W^{\parallel} = P_W^{\parallel} + P_F^{\parallel} \eta \frac{T_W}{T_F} \quad (14)$$

$$205 \quad \tilde{P}_W^{\perp} = P_W^{\perp} + P_F^{\perp} \eta \frac{T_W}{T_F} = \delta_W P_W^{\parallel} + \delta_F P_F^{\parallel} \eta \frac{T_W}{T_F} \quad (15)$$

206 Here δ_F and δ_W are the fluorescence and water vapor Raman depolarization ratios, defined in Eq.16

$$207 \quad \delta_F = \frac{P_F^{\perp}}{P_F^{\parallel}} \quad \delta_W = \frac{P_W^{\perp}}{P_W^{\parallel}} \quad (16)$$

208 Here we assume that depolarization ratio of fluorescence is the same at the wavelengths λ_W and
 209 λ_F . This assumption is usually valid, because emission is normally from the lowest singlet state,
 210 so the depolarization ratio is spectrally independent (Lakowicz, 2006).

211 Due to the presence of fluorescence, the depolarization ratio measured in the water vapor
 212 Raman channel is given by Eq.17

$$213 \quad \tilde{\delta}_W = \frac{\tilde{P}_W^{\perp}}{\tilde{P}_W^{\parallel}} = \frac{\delta_W P_W^{\parallel} + \delta_F P_F^{\parallel} \eta \frac{T_W}{T_F}}{P_W^{\parallel} + P_F^{\parallel} \eta \frac{T_W}{T_F}} \quad (17)$$

214 Here $\tilde{\delta}_W$ is the depolarization ratio that would be measured in the water vapor Raman channel in
 215 the absence of atmospheric fluorescence. From Eq.9, 10, 14, 15, 17 parameter η can be derived
 216 from lidar measurements, such as water vapor mixing ratio, \tilde{n}_v , depolarization ratio $\tilde{\delta}_w$ and
 217 fluorescence backscattering β_F :

$$218 \quad \eta = \frac{\tilde{n}_W}{\beta_F} \frac{K_F}{K_W} n_R \frac{(1 + \delta_F)(\tilde{\delta}_w - \delta_W)}{(1 + \tilde{\delta}_w)(\delta_F - \delta_W)} \quad (18)$$

219 It should be note, that the choice of calibration constants K_F , K_W does not influence η , because \tilde{n}_w
 220 and β_F are calculated with the same calibration constants. Finally, the increase of WVMR Δn_w
 221 induced by the fluorescence can be calculated following Eq.19:



$$\Delta n_w = K_w \frac{P_F \eta \frac{T_w}{T_F} T_R}{P_R T_w} = \frac{K_w}{K_F} \eta \beta_F \frac{1}{n_R} \quad (19)$$

As soon as parameter η is found from Eq.18, we can estimate error Δn_w from β_F , which in case of LILAS is measured at 466 nm. In such estimation we have to assume that relationship between fluorescence at 466 nm and 408 nm is constant (independent of height). Possibility to perform correction from single – channel fluorescence measurements was discussed by Reichardt et al. (2023), where it was shown, that for 466/408 nm channels, correction actually may depend on height. Corresponding analysis based on our measurements will be presented in Sect.3.2.

We should mention, that when depolarization of water vapor Raman is available, the contribution of fluorescence to WVMR can be obtained without using η . From Eq.18 and Eq.19 it comes:

$$\Delta n_w = \tilde{n}_w \frac{(1 + \delta_F)(\tilde{\delta}_w - \delta_w)}{(1 + \tilde{\delta}_w)(\delta_F - \delta_w)} \quad (20)$$

However, such correction can be performed only at low altitudes, where signal-to-noise ratio in cross-polarized water vapor channel is high enough.

3. Experimental results

In May – June 2023, the Canadian forest fires were at the origin of numerous smoke layers observations in a wide range of altitude, ranging from the BL to the tropopause. The Boreal wildfire season in 2023 started anomalously early. A wildfire in Alberta, Canada at 53.2° N, 115.7° W has produced an intense Pyrocumulonimbus (PyroCb) cloud on 5 May with the minimum satellite-derived infrared brightness temperature of -66° C, which should correspond to 10-11 km altitude according to the local radiosoundings. In order to describe the long-range transport of the smoke plume produced by this event, we use UV absorbing Aerosol Index (AI) measurements by the Ozone Monitoring and Profiling Suite (OMPS) Nadir Mapper (NM) instrument onboard Suomi NPP satellite mission (Flynn et al., 2014). AI is widely used as a proxy of the amount of absorbing aerosols (e.g smoke, dust, ash) and its dimensionless value is proportional to the altitude of the aerosol layers. The AI values above 15 are usually associated with the smoke plumes at or above the tropopause (Peterson et al., 2018 and references therein), whereas the maximum AI value reported by OMPS-NM instrument for the Alberta event amounted to 19.9.



250 Fig. 2 displays the spatiotemporal evolution of the smoke plume from the Alberta event
251 represented by the areas of enhanced AI observed between 5 – 21 May. The smoke in the upper
252 troposphere and lower stratosphere (UTLS) is carried by the westerly winds, crossing the Atlantic
253 in about 1 week before reaching Moscow region by 15 May. On that date, the Moscow lidar has
254 detected the smoke layer at 10-11 km (see Sect. 2). The plume was then further advected across
255 Eurasia towards northeastern Siberia. By 22 May the smoke plume completes its first
256 circumnavigation (not shown) and passes over Lille on 23 May and then over Moscow for the
257 second time around 27 May. Thus, we can expect, that the smoke layers observed over Lille and
258 Moscow have the same source.

259

260 **3.1 Variability of fluorescence depolarization ratio**

261 At the first stage of our research we focused on the variability of the fluorescence
262 depolarization ratio with aerosol types. The main attention was paid to smoke particles, because
263 they provide the strongest impact on the Raman water vapor measurements due to their high
264 fluorescence capacity.

265 Spatio-temporal distributions of the aerosol elastic and fluorescence backscattering
266 coefficients (β_{532} and β_F), on the night 26-27 June 2023, are shown in Fig.3. Dense smoke layer
267 with β_F as high as $7.0 \times 10^{-4} \text{ Mm}^{-1} \text{sr}^{-1}$ occurs within the 4.0 -10.0 km height range. The relative
268 humidity increases from 40% at 4 km to RH>90% at 7 km where formation of ice crystals starts.
269 Vertical profiles of aerosol elastic and fluorescence backscattering coefficients (β_{532} and β_F),
270 together with fluorescence capacity, are shown in Fig.3c. Inside the smoke layer, G_F is about 3×10^{-4} ,
271 which is a typical value for smoke whereas, above 6 km, it decreases due to ice formation. Ice
272 crystals increase the particle depolarization ratio δ_{532} from 3% at 6 km to 20% at 8 km.
273 Fluorescence signals are strongly depolarized. Inside the BL, δ_F is about 60% whereas above 2 km
274 it drops to approximately 45%. The processes of hygroscopic growth and ice formation do not
275 provide a noticeable impact on δ_F value. During May – June observations, the depolarization ratio
276 of smoke varied mainly inside the 45-55% range.

277 As discussed in our previous publications (Veselovskii, et al., 2022; Hu et al., 2022), the
278 fluorescence capacity of aged smoke varies inside the $(2.5-5.5) \times 10^{-4}$ range, probably due to the
279 changes in smoke composition and conditions of atmospheric transport. However, during Alberta
280 fires, several smoke plumes with high G_F have been observed. The highest fluorescence capacity



281 was observed on the night 16-17 June 2023. Vertical profiles of aerosol properties for this episode
282 are shown in Fig.4. Dense smoke layers with fluorescence backscattering exceeding 10.0×10^{-4}
283 $\text{Mm}^{-1}\text{sr}^{-1}$ occurred within 7.0 -9.0 km height range. In this case, the maximal value of fluorescence
284 capacity reached 10.0×10^{-4} . Fluorescence depolarization ratio is about 50% through the entire
285 smoke layer and the process of ice formation (just like in Fig.3d) does not influence δ_F . Thus, in
286 May - June 2023 strong variations of G_F in the $(2.5-10.0) \times 10^{-4}$ range were accompanied by
287 relatively small variations of δ_F remaining in the 45 - 55% interval.

288 It is known that in the UTLS smoke particles can reach depolarization ratio, δ_{532} , as high as
289 15-20% (Burton et al., 2015; Haarig et al., 2018; Hu et al., 2019; Ohneiser et al., 2020). High
290 values of the depolarization ratio are usually attributed to the complex internal structure of smoke
291 particles (Mishchenko et al., 2016). Two smoke events in the UTLS, characterized by enhanced
292 δ_{532} , on 28-29 May and 3-4 June 2023, are illustrated on Fig.5. On 28-29 May, three smoke layers,
293 at ~ 3.5, 6.5 and 11.5 km can be distinguished. High depolarization ratios, reaching 40% at altitudes
294 of 9.8-10.5 km, are due to ice clouds. In the lower smoke plumes ranging between 3.5 and 6.5 km,
295 the particle depolarization did not exceed 8% whereas above 11 km δ_{532} increases to 15%. High
296 values of δ_{532} observed in the UTLS correlate with increase of G_F and with fluorescence
297 depolarization, δ_F , up to 7.0×10^{-4} and 70% respectively. Similar behavior was observed on 3-4
298 June, where depolarization ratio, δ_{532} , above 11.5 km increased up to 15%, simultaneously with an
299 increase of G_F and δ_F up to 9.5×10^{-4} and 70% respectively. Thus, change in particle morphology
300 may affect the depolarization ratio of fluorescence. Another possibility is that, in the UTLS, not
301 only the particle structure can change, but composition as well. At the current stage of analysis,
302 we are not yet able to conclude about the mechanisms explaining the increase of fluorescence
303 depolarization in the UTLS.

304 We did not observe the effect of atmospheric humidity on smoke fluorescence
305 depolarization. However, inside the BL the observed hygroscopic growth was accompanied by an
306 increase of δ_F . During the 9-16 June 2023 period numerous particle hygroscopic growth cases were
307 observed in the BL. One of such cases, on the night of 12-13 June, is shown in Fig.6. The relative
308 humidity increases inside the BL from 50% to 70% causing an increase of β_{532} near the BL top.
309 Depolarization ratio δ_{532} decreases with height, since the particles in the process of hygroscopic
310 growth become more spherical. The fluorescence depolarization ratio, however, increases inside
311 the boundary layer from 50 to 70%.



312 All results obtained during 9-16 June, showing dependence of δ_F and δ_{532} on the relative
313 humidity, are summarized in Fig.7. Particle depolarization δ_{532} systematically decreased with RH
314 but, on 16 June, this dependence is not monotonic which could be due to the change of aerosol
315 composition with height. At low RH (below 30%), fluorescence depolarization ratio is about 50%.
316 However, at RH about 90%, δ_F increases up to 70%. One possible explanation of δ_F behavior can
317 be an increase of rotational mobility of the molecules in the process of particle water uptake.

318

319 ***3.2 Fluorescence spectrum sampled with a with 5-channel lidar***

320 The results presented in the previous section were obtained with a single channel
321 fluorescence lidar. However, for analyzing the variability of smoke properties (for example,
322 increase of fluorescence capacity with height) it is important to have information about total
323 fluorescence spectrum. Moreover, to estimate the fluorescence contamination in the Raman water
324 vapor channel, a relationship between fluorescence backscattering at 466 nm and 408 nm is used.
325 Thus we need to know the variability of the fluorescence spectrum in the short wavelength region.
326 In our recent work (Veselovskii et al., 2023) we presented the first results obtained with a 5-
327 channel fluorescence lidar in operation at the GPI. This lidar is able to measure fluorescence
328 backscattering in 5 spectral intervals centered at 438, 472, 513, 560, and 614 nm. In May – June
329 2023, several smoke plumes originating from Alberta fires were transported over Moscow.
330 Although Lille and Moscow are very distant from each other, smoke plumes observed have the
331 same origin, hence the fluorescence spectra measured over Moscow are quite helpful for the
332 analysis of Lille data.

333 Fig.8 presents fluorescence spectral backscattering coefficients, B_λ , for 3 smoke events
334 detected in the UTLS above 10, 8 and 10 km for 15, 31 May and 20 June 2023, respectively. On
335 15 and 31 May smoke layers are also present inside the 4-6 km range. Inside the BL the strongest
336 fluorescence is systematically detected in the 438 nm channel while, at higher altitudes, the
337 maxima shifts to 560 nm. As follows from Fig.8d-f, the ratio B_{560}/B_{438} remains in the range 0.4 -
338 0.7 inside the BL whereas this ratio increases above 2.0 in the UTLS. Thus, for smoke events the
339 maxima of the fluorescence spectrum shifts with height towards longer wavelengths. The ratio
340 B_{513}/B_{355} also increases with height and, above 10 km, it reaches the values of $1 \times 10^{-5} \text{ nm}^{-1}$. In the
341 UTLS, the maximal fluorescence capacity, G_F , measured by LILAS at 466 nm (with 44 nm
342 bandwidth filter) was about 10×10^{-4} . In the smoke layer, the ratio of backscattering coefficients



343 β_{355}/β_{532} is about 2, so the maximal ratio B_{466}/β_{355} derived from LILAS measurements is about
344 $1.1 \times 10^{-5} \text{ nm}^{-1}$. Thus, values obtained over Lille and over Moscow are in agreement.

345 The fluorescence spectra obtained for the above mentioned smoke plumes are shown in
346 Fig.9. The values of B_λ are normalized to B_{438} . Inside the BL, the maximum of fluorescence is
347 measured at 438 nm and it decreases with wavelength. In the smoke layers within 4 - 6 km, the
348 maximum of fluorescence is observed at 513 nm while, in the UTLS, the maximum shifts to 560
349 nm.

350 When applying Eq.19 to estimate the contribution of smoke fluorescence into the Raman
351 water vapor channel of LILAS, we assume that the ratio of the fluorescence backscattering at 466
352 nm to 408 nm is constant. For the lidar in operation at GPI, the shortest available wavelength is
353 438 nm, therefore, at least, one can estimate the variability of the ratio B_{472}/B_{438} . Fig. 10 presents
354 vertical profiles of B_{472}/B_{438} for 11 smoke events occurring during the 15 May – 20 June 2023
355 period. Inside the BL, this ratio varies in the 0.6 – 1.0 range. Lowest values correspond to urban
356 aerosols while, values of B_{472}/B_{438} close to 1.0, probably indicate the presence of smoke particles
357 inside the BL. Smoke layers start mainly above 4.0 km and B_{472}/B_{438} shows a tendency to increase
358 in the UT. It is interesting that, for the period 15 May – 1 June, the ratio was close to 1.5 whereas
359 after 1 June, it became close to 1.0, which can be related to changing of smoke source. Mean value
360 of B_{472}/B_{438} in the 4.0 – 11.0 km range over all observations is 1.38 with standard deviation of 0.23
361 (relative variation is about 17%). The wavelength separation between 466 nm and 408 nm channels
362 is 1.7 larger, so one can expect variation of B_{466}/B_{408} in the smoke layer up to ~30%. This is a very
363 rough estimation, but it points out the difficulties to face when the estimation of the fluorescence
364 contamination to the Raman water vapor channel is performed from a single fluorescence channel
365 at 466 nm. This issue was also discussed in the publication of Reichardt et al. (2023).

366

367 ***3.3 Estimation of fluorescence impact on water vapor Raman measurements***

368 Measuring the depolarization ratio in the water vapor Raman channel provides an
369 opportunity to control/evaluate the presence of fluorescence leak in this channel. These
370 depolarization measurements were performed in Lille during May – June 2023. Vertical profiles
371 of water vapor depolarization ratio $\tilde{\delta}_w$ together with \tilde{n}_w , β_{532} , β_F , and G_F are shown in Fig.11 for
372 the night 8-9 and 10-11 June 2023. On 8-9 June aerosols are confined mainly below 5 km. The
373 fluorescence capacity is about 1.0×10^{-4} below 3.0 km, but above, G_F increases up to 2.5×10^{-4} ,



374 indicating to the presence of smoke. The depolarization ratio in the water vapor channel is about
375 2% in the height range 1.5 km – 3.5 km. The values of $\tilde{\delta}_w$ ranging inside 1.8%÷2.0% were
376 observed for this height range, where contribution of fluorescence was insignificant.
377 Depolarization ratio δ_w is low, because the interference filter in water vapor channel selects only
378 strongest Q-branch lines and most of rotational lines are blocked. Contribution of fluorescence
379 becomes noticeable above 3.5 km where n_w drops, resulting in an increase of $\tilde{\delta}_w$ up to ~3%. There
380 is also increase of $\tilde{\delta}_w$ up to 2.2% below 1.0 km, where fluorescence backscattering is enhanced.
381 Similar values of $\tilde{\delta}_w$ were observed on 10-11 June, where depolarization ratio increases up to
382 2.5% inside the smoke layer observed at ~3.75 km and below 2.0 km.

383 As discussed in section 2.2, the contribution of fluorescence to the WVMR can be derived
384 from Eq.20 if $\tilde{\delta}_w$ and δ_F are measured. Fig.12 presents the modeling of the relative error $\frac{\Delta n_w}{\tilde{n}_w}$,
385 introduced by the fluorescence to WVMR as a function of $\tilde{\delta}_w$. Computations are performed for
386 fluorescence depolarization ratio $\delta_F=50\%$, 60%, 70% to include both smoke and urban particles.
387 Depolarization ratio in the Raman water vapor channel in the absence of fluorescence was assumed
388 to be $\delta_w=2\%$. For depolarization ratio $\tilde{\delta}_w$ below 3% the relative error $\frac{\Delta n_w}{\tilde{n}_w}$ did not exceed 3%.
389 As follows from the fluorescence spectra in Fig.9, the fluorescence of urban particles increases
390 towards short wavelengths, thus one can expect impact of the urban aerosol fluorescence on vapor
391 measurement. In practices, however, we did not observe $\tilde{\delta}_w$ exceeding 3% in the BL thus,
392 contribution of aerosol in the BL is not critical. The reason is due to the low fluorescence capacity
393 (about one order lower than that of smoke) and higher water vapor content, comparing to free
394 troposphere.

395 Profiles of $\tilde{\delta}_w$ shown in Fig.11 become noisy at heights where n_w is low, and $\tilde{\delta}_w$ can not be
396 used for correction of fluorescence effect in the UT. To overcome this, one derived the parameter
397 η from Eq.18 at low altitudes where $\tilde{\delta}_w$ is available, and, then, this η is used to calculate Δn_w from
398 Eq.19 in the entire height range. In such an approach, however, one has to assume that relationship
399 between fluorescence cross sections at 466 nm and 408 nm remains constant with height. As



400 discussed in previous section, such assumption can yield significant bias in calculation of Δn_w ,
401 and, at this stage, we do not provide corrected profiles of WVMR.

402 For accurate calculation of η one needs smoke events with strongly enhanced $\tilde{\delta}_w$, which is
403 usually observed in the dry smoke layers. Such suitable events are shown for the night 26-27 May
404 and 5-6 June 2023 in Fig.13. On 26-27 May a smoke layer characterized by high fluorescence (β_F
405 up to $5 \times 10^{-4} \text{ Mm}^{-1} \text{sr}^{-1}$) and low \tilde{n}_w (below 0.2 g/kg) is observed at 3.5 km. Fluorescence
406 depolarization ratio is about 47% and $\tilde{\delta}_w$ increases from 2% up to 12% in the middle of this layer.
407 Parameter η calculated from Eq.18 inside this smoke layer is about $2 \times 10^{-3} \text{ (g/kg)/(Mm}^{-1} \text{sr}^{-1})$. On
408 5-6 June the depolarization ratio $\tilde{\delta}_w$ in the smoke layer increased up to 10% and value of η is very
409 similar. Parameters η derived for several smoke episodes vary in the range $(2 \div 2.5) \times 10^{-3}$
410 $\text{(g/kg)/(Mm}^{-1} \text{sr}^{-1})$. For the estimate of Δn_w one used the mean value of $\eta = 2.25 \times 10^{-3} \text{ (g/kg)/(Mm}^{-1}$
411 $\text{sr}^{-1})$, which is suitable only for smoke, while for particles in the BL, η can be different. However,
412 in the BL, low depolarization ratio $\tilde{\delta}_w$ prevented us from calculating η .

413 Fig.14 presents vertical profiles of WVMR, fluorescence backscattering and error Δn_w
414 introduced by the fluorescence in WVMR on 26-27 May, 28-29 May and 16-17 June. Smoke layers
415 with strong fluorescence occurred systematically in our UT observations. The current LILAS
416 system is not powerful enough for deriving accurate water vapor measurements above 10 km,
417 however increase of \tilde{n}_w in fluorescent smoke layers is visible. We remind that Eq.19 for Δn_w
418 contains factor $\frac{1}{n_R}$ (inverse relative change of nitrogen number density), thus the fluorescence
419 impact on WVMR increases with height. The uncertainties $\frac{\Delta n_w}{\tilde{n}_w}$ for all events considered are
420 shown in Fig.14d. On 26-27 and 28-29 May the uncertainty at 11 km is of the order of 100%. On
421 16 June the smoke layer is lower (at 9 km) and the uncertainty is about 50%. Our demonstration
422 shows that smoke fluorescence can significantly impact water vapor measurements. The proposed
423 approach, based on the analysis of the depolarization ratio of the water vapor signal, has potential
424 for estimation of corresponding errors and their correction.

425 **4. Conclusion**



426 Modern fluorescence spectroscopy widely uses depolarization measurements of the
427 fluorescence emission induced by polarized laser radiation. However, in application to lidar
428 atmospheric observations, measurement of fluorescence depolarization ratio, presented in this
429 study, is one of the first efforts in this direction. Analysis of more than 30 spring and summer
430 smoke events allows evaluation of the main aerosol intensive properties, including fluorescence
431 capacity, particle and fluorescence depolarization ratio. The fluorescence capacity varied within
432 $(2.5 \div 10.0) \times 10^{-4}$ range while the particle depolarization ratio δ_{532} remained below 10%. However,
433 in spite of strong G_F variation, δ_F was remaining within a relatively narrow interval 45-55%.
434 Additional observations revealed that for smoke plumes in the upper troposphere δ_{532} increased up
435 to 15% and fluorescence depolarization increased up to 70%. At the moment, one cannot fully
436 explain the mechanism responsible for this δ_F increase. It can be related to complex particle
437 internal structure at high altitudes, as well as to the change of the chemical composition, revealed
438 by the shift of the maximum of fluorescence spectra to longer wavelengths in the upper troposphere
439 (Fig. 9).

440 Inside the BL, the fluorescence depolarization ratio was higher than that of smoke and varied
441 inside the 50-70% range. Moreover, fluorescence depolarization ratio of urban particles strongly
442 depends on the relative humidity and, in contrast to elastic scattering, depolarization of
443 fluorescence increases with RH. One possible origin of this phenomena could be attributed to an
444 increase of rotational mobility of the molecules involved in the process of water uptake since δ_F
445 increases when rotation time of molecules becomes comparable with time of fluorescence
446 emission.

447 The depolarization ratio of Raman water vapor backscatter, in the absence of fluorescence,
448 appears to be quite low ($\delta_w = 2 \pm 0.5\%$), because the narrowband interference filter in the water vapor
449 channel selects only strong Q-lines of the Raman spectrum. As a result, the depolarization ratio of
450 Raman water vapor backscatter is sensitive to the presence of strongly depolarized fluorescence
451 signals. Contribution of fluorescence to the WVMR can be calculated from $\tilde{\delta}_w$ with the only
452 assumption that δ_F remains constant within 408 - 466 nm. However, the depolarization ratio of
453 Raman water vapor backscatter is weak and measurements are only possible up to the middle
454 troposphere with the lidar used in the work, while the problem of fluorescence interference is the
455 most crucial in UTLS. To solve this problem, one can derive η , a parameter linking fluorescence



456 at 466 nm and at 408 nm. This parameter is calculated for specific smoke events, at low altitudes,
457 and then is used for processing all observations and altitudes.

458 Such an approach relies on the assumption that the ratio of fluorescence between 466 nm
459 and 408 nm remains constant and allows only a rough estimation of the correction term for the
460 water vapor mixing ratio, Δn_W . One possible solution to improve accuracy of Δn_W is to implement
461 an additional and shorter wavelength channel (438 nm or even shorter). Another technical solution
462 could be considered as the depolarization ratio of Raman water vapor backscatter is low, therefore
463 the 408 nm component can be efficiently selected with a polarizing cube. The depolarized channel
464 then can be used for fluorescence measurements. Polarizing cube works in a wide spectral range,
465 so one can select the region outside of the water vapor spectrum (400 nm – 418 nm) for
466 fluorescence monitoring. We plan this experiment as well as other innovative approaches with our
467 future high power fluorescence lidar, LIFE (Laser Induced Fluorescence Explorer), whose start of
468 operation is scheduled at the beginning of 2024.

469

470 **Data availability.** Lidar measurements are available upon request
471 (philippe.goloub@univ-lille.fr).

472

473 **Author contributions.** IV processed the data and wrote the paper. QH and TP performed the
474 measurements in Lille. PG supervised the project and helped with paper preparation. WB modified
475 LILAS for polarization measurements. MK and NK performed the measurements in Moscow. SK
476 analyzed transport of smoke layers and RM derived RH profiles from lidar measurements.

477

478 **Competing interests.** The authors declare that they have no conflict of interests.

479

480 **Acknowledgement**

481 We acknowledge funding from the CaPPA project funded by the ANR through the PIA under
482 contract ANR-11-LABX-0005-01, the “Hauts de France” Regional Council (project ECRIN) and
483 the European Regional Development Fund (FEDER). ESA/QA4EO program is greatly
484 acknowledged for supporting the observation activity at LOA. The work from Q. Hu was
485 supported by Agence Nationale de Recherche ANR (ANR-21-ESRE-0013) through the
486 OBS4CLIM project. Development of fluorescence lidar in Moscow was supported by Russian
487 Science Foundation (project 21-17-00114). The work of S. Khaykin was partly supported by the
488 Agence Nationale de la Recherche (ANR) 21-CE01- 335 0007-01 PyroStrat project.



489

490 **References**

491

492 Burton, S.P., Hair, J.W., Kahnert, M., Ferrare, R.A., Hostetler, C.A., Cook, A.L., Harper, D.B.,
493 Berkoff, T.A., Seaman, S.T., Collins, J.E., Fenn, M.A., and Rogers, R.R.: Observations of the
494 spectral dependence of linear particle depolarization ratio of aerosols using NASA Langley
495 airborne High Spectral Resolution Lidar, *Atmos. Chem. Phys.*, 15, 13453–13473,
496 <https://doi.org/10.5194/acp-15-13453-2015>, 2015.

497 Chouza, F., Leblanc, T., Brewer, M., Wang, P., Martucci, G., Haefele, A., Vèrèmes, H., Duflot,
498 V., Payen, G., and Keckhut, P.: The impact of aerosol fluorescence on long-term water vapor
499 monitoring by Raman lidar and evaluation of a potential correction method, *Atmos. Meas.*
500 *Tech.*, 15, 4241–4256, <https://doi.org/10.5194/amt-15-4241-2022>, 2022.

501 Flynn, L., Long, C., Wu, X., Evans, R., Beck, C. T., Petropavlovskikh, I., McConville, G.,
502 Yu, W., Zhang, Z., Niu, J., Beach, E., Hao, Y., Pan, C., Sen, B., Novicki, M., Zhou, S., Sefator,
503 C.: Performance of the Ozone Mapping and Profiler Suite (OMPS) products, *J. Geophys. Res.*
504 *Atmos.*, 119, 6181–6195, 2014. doi:10.1002/2013JD020467

505 Freudenthaler, V., Esselborn, M., Wiegner, M., Heese, B., Tesche, M. and co-authors:
506 Depolarization ratio profiling at several wavelengths in pure Saharan dust during SAMUM
507 2006, *Tellus* 61B, 165–179, 2009.

508 Haarig, M., Ansmann, A., Baars, H., Jimenez, C., Veselovskii, I., Engelmann, R., and Althausen,
509 D.: Depolarization and lidar ratios at 355, 532, and 1064 nm and microphysical properties of
510 aged tropospheric and stratospheric Canadian wildfire smoke, *Atmos. Chem. Phys.*, 18, 11847–
511 11861, <https://doi.org/10.5194/acp-18-11847-2018>, 2018.

512 Hu, Q., Goloub, P., Veselovskii, I., Bravo-Aranda, J.-A., Popovici, I. E., Podvin, T., Haefelin,
513 M., Lopatin, A., Dubovik, O., Pietras, C., Huang, X., Torres, B., and Chen, C.: Long-range-
514 transported Canadian smoke plumes in the lower stratosphere over northern France, *Atmos.*
515 *Chem. Phys.*, 19, 1173–1193, 2019. <https://doi.org/10.5194/acp-19-1173-2019>.

516 Hu, Q., Goloub, P., Veselovskii, I., and Podvin, T.: The characterization of long-range transported
517 North American biomass burning plumes: what can a multi-wavelength Mie-Raman-
518 polarization-fluorescence lidar provide? *Atmos. Chem. Phys.* 22, 5399–5414, 2022
519 <https://doi.org/10.5194/acp-22-5399-2022>



- 520 Immler, F. and Schrems, O.: Is fluorescence of biogenic aerosols an issue for Raman lidar
521 measurements? Proc. SPIE 5984, Lidar Technologies, Techniques, and Measurements for
522 Atmospheric Remote Sensing, 59840H, <https://doi.org/10.1117/12.628959>, 2005.
- 523 Immler, F., Engelbart, D., and Schrems, O.: Fluorescence from atmospheric aerosol detected by a
524 lidar indicates biogenic particles in the lowermost stratosphere, *Atmos. Chem. Phys.*, 5, 345–
525 355, <https://doi.org/10.5194/acp-5-345-2005>, 2005.
- 526 Lakowicz, J. R.: Principles of Fluorescence Spectroscopy, Springer New York, NY, 2006.
527 <https://doi.org/10.1007/978-0-387-46312-4>
- 528 Liu, F., Yi, F., He, Y., Yin, Z., Zhang, Y., and Yu, C.: Spectrally Resolved Raman Lidar to
529 Measure Backscatter Spectra of Atmospheric Three-Phase Water and Fluorescent Aerosols
530 Simultaneously: Instrument, Methodology, and Preliminary Results, *IEEE Transactions on*
531 *Geoscience and Remote Sensing*, 60, 5703013, 2022, doi: 10.1109/TGRS.2022.3166191
- 532 Mishchenko MI, Dlugach JM, Liu L. Linear depolarization of lidar returns by aged smoke
533 particles. *Appl Opt.* 55, 9968-9973, doi: 10.1364/AO.55.009968, 2016.
- 534 Ohneiser, K., Ansmann, A., Baars, H., Seifert, P., Barja, B., Jimenez, C., Radenz, M., Teisseire,
535 A., Floutsi, A., Haarig, M., Foth, A., Chudnovsky, A., Engelmann, R., Zamorano, F., Bühl,
536 J., and Wandinger, U.: Smoke of extreme Australian bushfires observed in the stratosphere
537 over Punta Arenas, Chile, in January 2020: optical thickness, lidar ratios, and depolarization
538 ratios at 355 and 532 nm, *Atmos. Chem. Phys.*, 20, 8003–8015, [https://doi.org/10.5194/acp-](https://doi.org/10.5194/acp-20-8003-2020)
539 [20-8003-2020](https://doi.org/10.5194/acp-20-8003-2020), 2020.
- 540 Peterson, D.A., Campbell, J.R., Hyer, E.J. et al. Wildfire-driven thunderstorms cause a volcano-
541 like stratospheric injection of smoke, *npj Clim. Atmos. Sci.* 1, 30, 2018.
542 <https://doi.org/10.1038/s41612-018-0039-3>
- 543 Rao, Z., He, T., Hua D, Wang, Y., Wang, X., Chen, Y., Le J.: Preliminary measurements of
544 fluorescent aerosol number concentrations using a laser-induced fluorescence lidar, *Appl. Opt.*
545 57, 7211-7215, <https://doi.org/10.1364/AO.57.007211>, 2018.
- 546 Reichardt, J.: Cloud and aerosol spectroscopy with Raman lidar, *J. Atmos. Ocean. Tech.*, 31,
547 1946–1963, <https://doi.org/10.1175/JTECH-D-13-00188.1>, 2014.
- 548 Reichardt, J., Leinweber, R., Schwebe, A.: Fluorescing aerosols and clouds: investigations of co-
549 existence, *EPJ Web Conf.*, 176, 05010, <https://doi.org/10.1051/epjconf/201817605010>, 2018.



- 550 Reichardt, J., Behrendt, O., and Lauer mann, F.: Spectrometric fluorescence and Raman lidar:
551 absolute calibration of aerosol fluorescence spectra and fluorescence correction of humidity
552 measurements, *Atmos. Meas. Tech.*, 16, 1–13, 2023. <https://doi.org/10.5194/amt-16-1-2023>.
- 553 Sugimoto, N., Huang, Z., Nishizawa, T., Matsui, I., Tatarov, B.: Fluorescence from atmospheric
554 aerosols observed with a multichannel lidar spectrometer," *Opt. Expr.* 20, 20800-20807,
555 <https://doi.org/10.1364/OE.20.020800>, 2012.
- 556 Veselovskii, I., Hu, Q., Goloub, P., Podvin, T., Korenskiy, M., Pujol, O., Dubovik, O., Lopatin,
557 A.: Combined use of Mie-Raman and fluorescence lidar observations for improving aerosol
558 characterization: feasibility experiment, *Atm. Meas. Tech.*, 13, 6691–6701, 2020.
559 doi.org/10.5194/amt-13-6691-2020.
- 560 Veselovskii, I., Hu, Q., Goloub, P., Podvin, T., Barchunov, B., and Korenskiy, M.: Combining
561 Mie–Raman and fluorescence observations: a step forward in aerosol classification with lidar
562 technology, *Atmos. Meas. Tech.*, 15, 4881–4900, 2022b. [https://doi.org/10.5194/amt-15-](https://doi.org/10.5194/amt-15-4881-2022)
563 [4881-2022](https://doi.org/10.5194/amt-15-4881-2022).
- 564 Veselovskii, I., Kasianik, N., Korenskiy, M., Hu, Q., Goloub, P., Podvin, T., and Liu, D.:
565 Multiwavelength fluorescence lidar observations of smoke plumes, *Atmos. Meas. Tech.*, 16,
566 2055–2065, 2023. <https://doi.org/10.5194/amt-16-2055-2023>
- 567 Wang, Y., Huang, Z., Zhou, T., Bi, J., Shi J.: Identification of fluorescent aerosol observed by a
568 spectroscopic lidar over northwest China, *Optics Express*, 31, 22157,
569 <https://doi.org/10.1364/OE.493557>, 2023.
- 570 Whiteman, D. N.: Examination of the traditional Raman lidar technique. I. Evaluating the
571 temperature dependent lidar equations, *Appl. Optics*, 42, 2571–2592,
572 <https://doi.org/10.1364/AO.42.002571>, 2003.
- 573

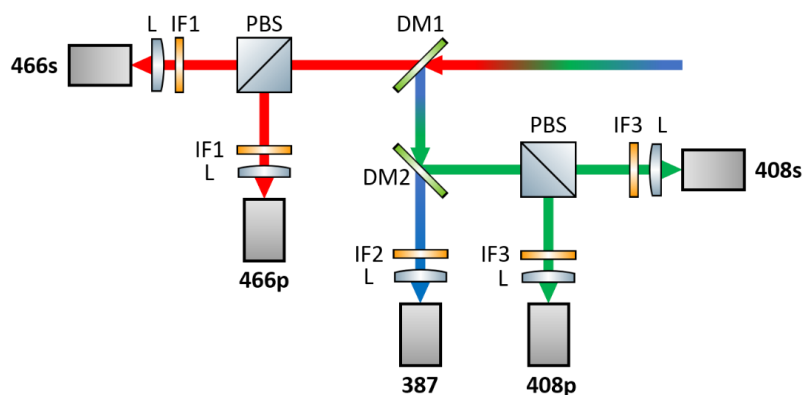

574

575 Fig.1. Optical layout of depolarization measurements at 408 nm and 466 nm wavelengths. L –
576 lens; IF1 - IF3 – interference filters, DM1, DM2 – dichroic mirrors, PBS – polarizing cube.

577

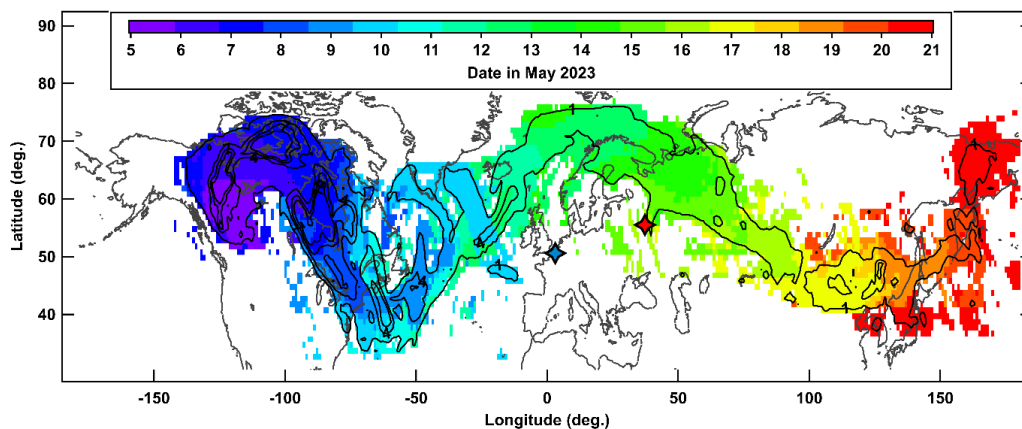

578

579 Fig.2. Spatiotemporal evolution of the smoke plume from the wildfire event in Alberta, Canada on
580 5 May 2023. Color-filled time-coded areas indicate the occurrences of Aerosol Index (AI) values
581 from OMPS-NPP instrument exceeding 0.5. The actual AI values (1-10) are shown in contours.
582 The blue and red-filled stars indicate the location of Lille and Moscow lidar stations respectively.
583



584
 585

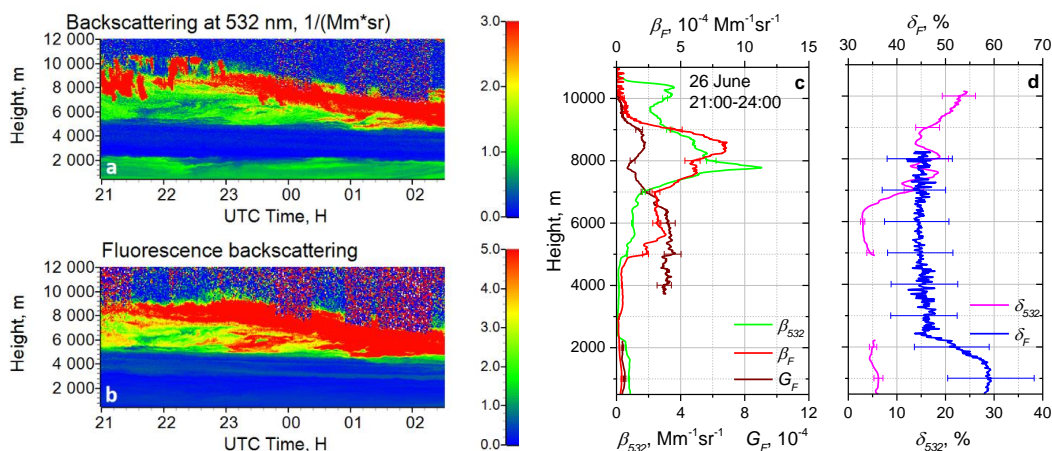

586
 587
 588
 589
 590
 591
 592

Fig.3. Smoke event on the night 26-27 June 2023. Spatio-temporal distributions of (a) aerosol backscattering coefficient β_{532} and (b) fluorescence backscattering β_F (in $10^{-4} \text{ Mm}^{-1} \text{ sr}^{-1}$). Vertical profiles of (c) the aerosol β_{532} and fluorescence β_F backscattering coefficients, the fluorescence capacity G_F ; (d) the particle δ_{532} and the fluorescence δ_F depolarization ratios.

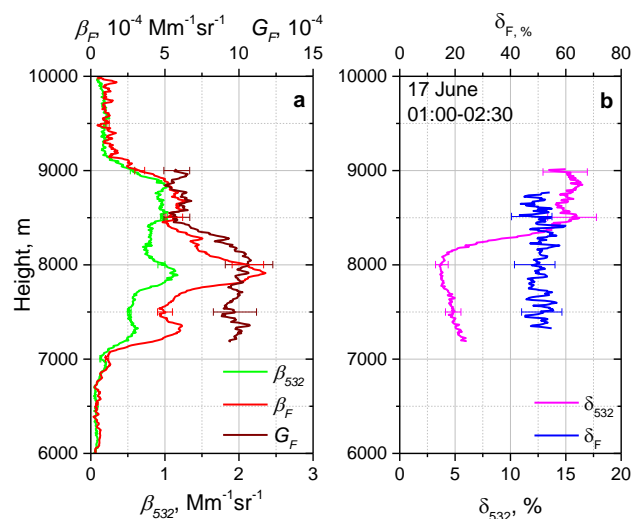

593
 594
 595
 596
 597
 598

Fig.4. Vertical profiles of (a) aerosol β_{532} and fluorescence β_F backscattering coefficients, fluorescence capacity G_F and (b) particle δ_{532} and fluorescence δ_F depolarization ratios on the night 16-17 June 2023 for period 01:00-02:30 UTC.



599
600

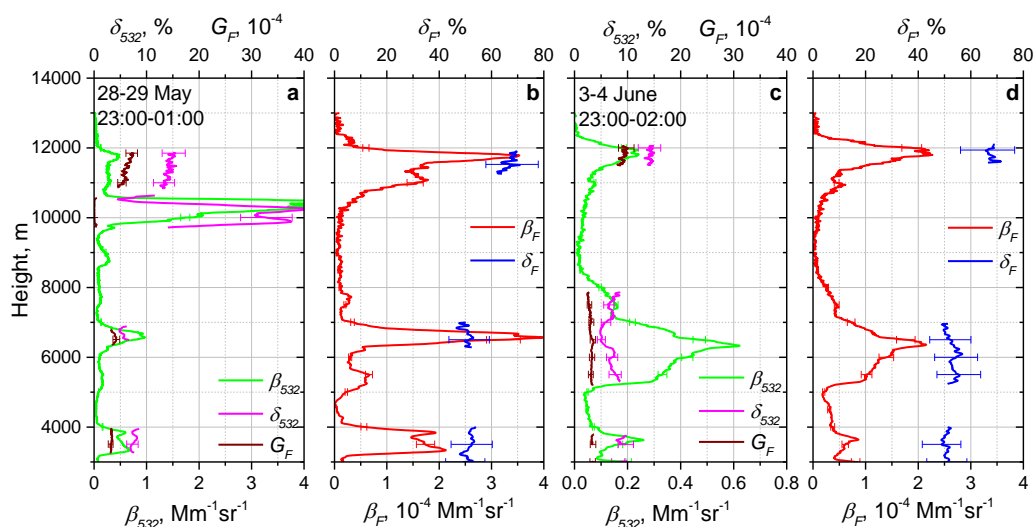

601
602
603
604
605
606

Fig.5. Vertical profiles of (a, c) backscattering coefficient β_{532} , particle depolarization ratio δ_{532} , fluorescence capacity G_F and (b, d) fluorescence backscattering β_F and fluorescence depolarization ratio δ_F for two smoke episodes on the nights 28-29 May 2023 and 3-4 June 2023.



607

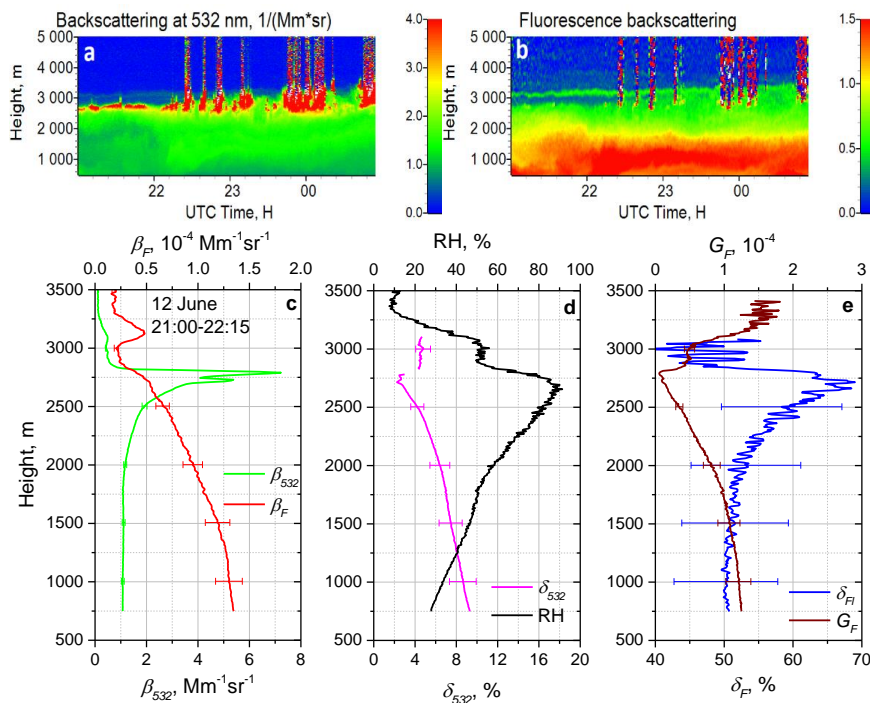

608

609

610

611

612

613

614

615

616

Fig.6. Particle hygroscopic growth in the boundary layer on the night 12-13 June 2023. Spatio-temporal distributions of (a) aerosol backscattering coefficient β_{532} and (b) fluorescence backscattering β_F (in $10^{-4} \text{ Mm}^{-1} \text{sr}^{-1}$). Vertical profiles of (c) aerosol β_{532} and fluorescence β_F backscattering coefficients; (d) particle depolarization ratio δ_{532} and the relative humidity RH; (e) fluorescence depolarization ratio δ_F and fluorescence capacity G_F for the time period 21:00-22:15 UTC.



617
618
619

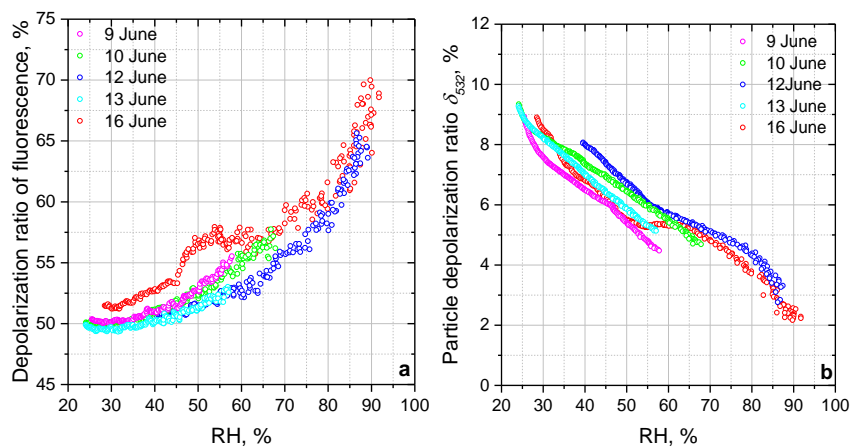

620
621
622
623
624

Fig. 7. (a) Fluorescence depolarization ratio and (b) particle depolarization ratio δ_{532}^p as a function of the relative humidity in the boundary layer for the measurements on 9, 10, 12, 13, 16 June 2023.

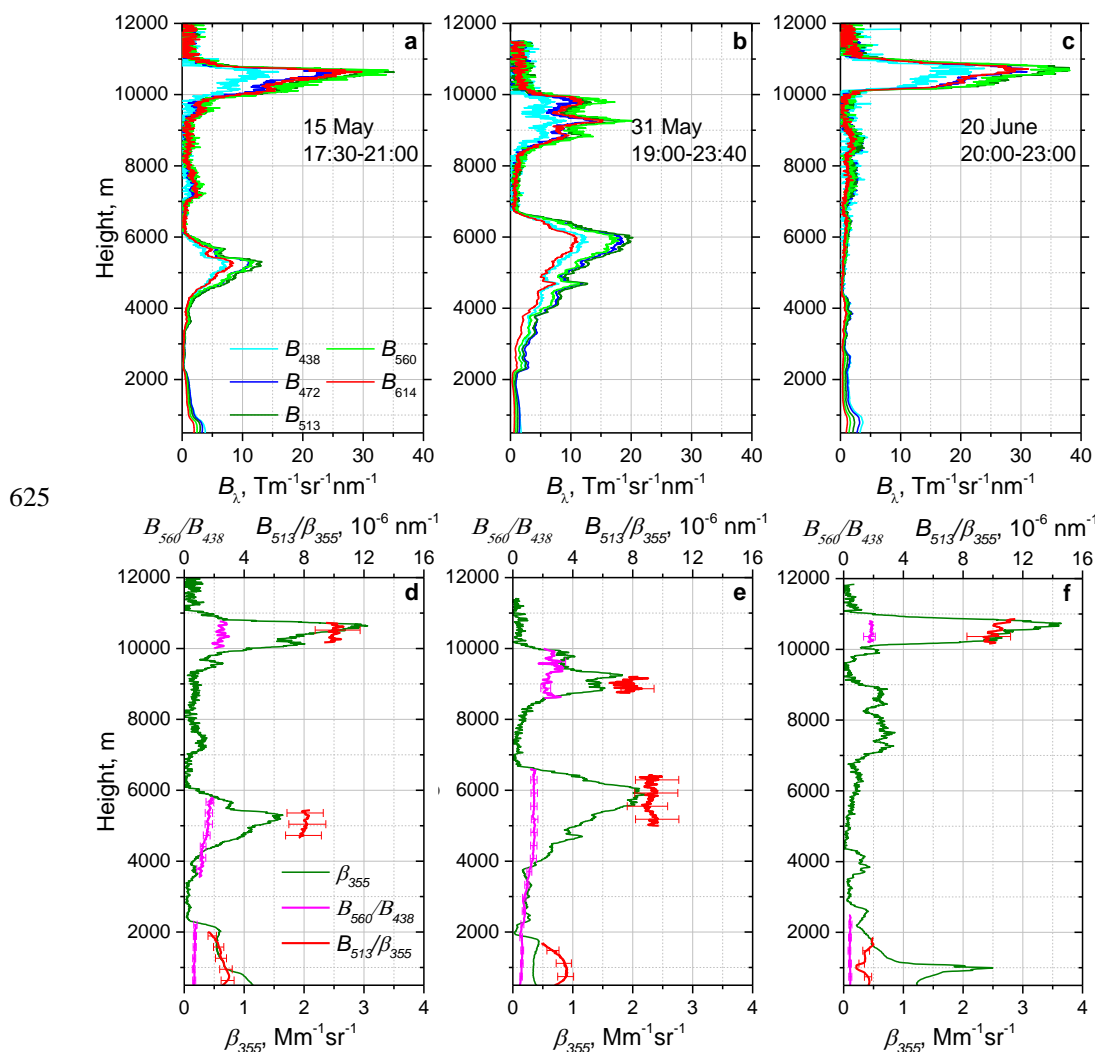
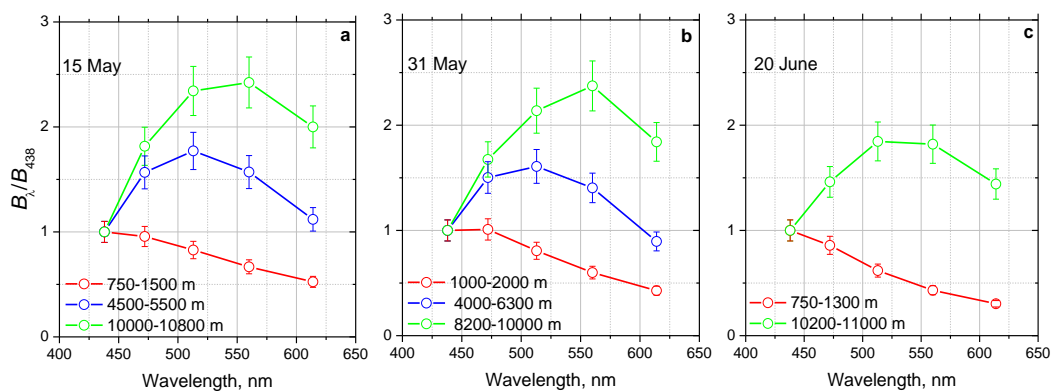

Fig. 8. Fluorescence measurements in Moscow on 15 May, 31 May, 20 June 2023. Vertical profiles of (a-c) fluorescence spectral backscattering coefficients B_λ at 438, 472, 513, 560, 614 nm and (d-f) aerosol backscattering coefficient β_{355} , the ratio B_{560}/B_{438} and B_{513}/β_{355} . Measurements were performed at an angle of 48 dg to horizon.



632

633 Fig.9. Fluorescence spectra B_{λ}/B_{438} at different height intervals measured during smoke episodes
634 on 15 May, 31 May, 20 June 2023 for the same temporal intervals as in Fig.8.

635

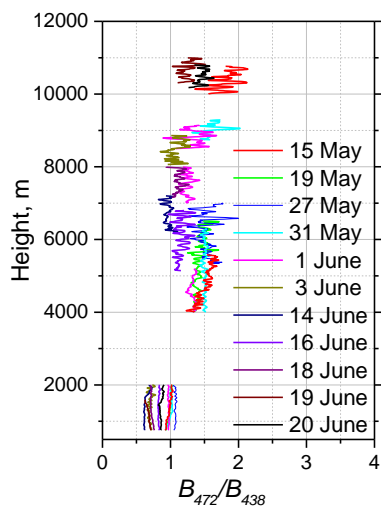

636

637 Fig.10. Height profiles of ratio B_{472}/B_{438} for smoke episodes during 15 May – 20 June 2023. Smoke
638 layers start above 4000 m.

639

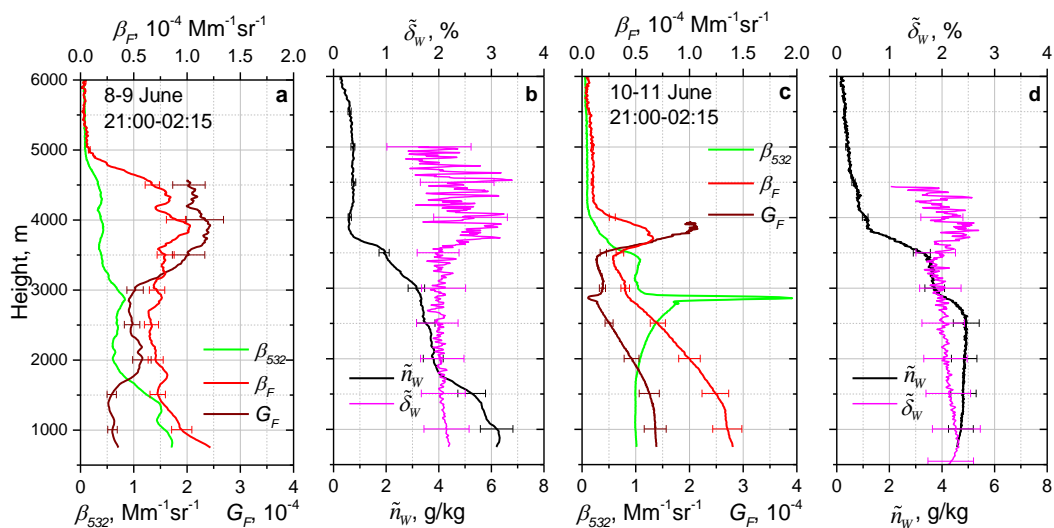

640
 641
 642
 643
 644
 645

Fig.11. Impact of aerosol fluorescence on the depolarization ratio in the water vapor Raman channel on the nights 8-9 and 10-11 June 2023 at Lille. Vertical profiles of (a, c) particle backscattering β_{532} , fluorescence backscattering β_F , fluorescence capacity G_F and (b, d) depolarization ratio $\tilde{\delta}_W$ of water vapor Raman signal and the water vapor mixing ratio \tilde{n}_W .

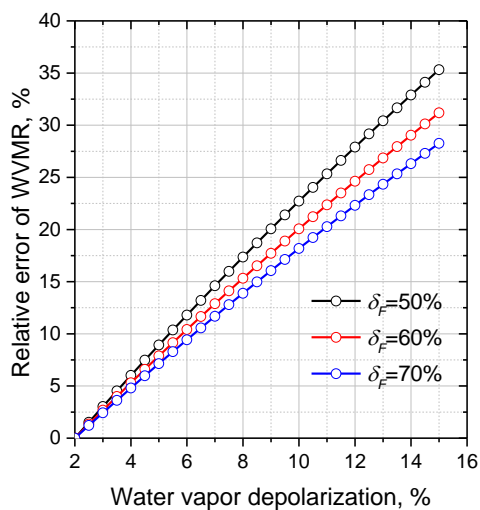

646

647 Fig.12. Relative error of water vapor mixing ratio (WVMR) $\frac{\Delta n_w}{\tilde{n}_w}$ induced by the fluorescence as

648 a function of depolarization ratio $\tilde{\delta}_w$ in the water vapor Raman channel for three values of
649 fluorescence depolarization ratio $\delta_F=50\%$, 60% , 70% . The depolarization ratio of water vapor
650 Raman backscatter in the absence of fluorescence is assumed to be $\delta_w=2\%$.

651

652



653
 654

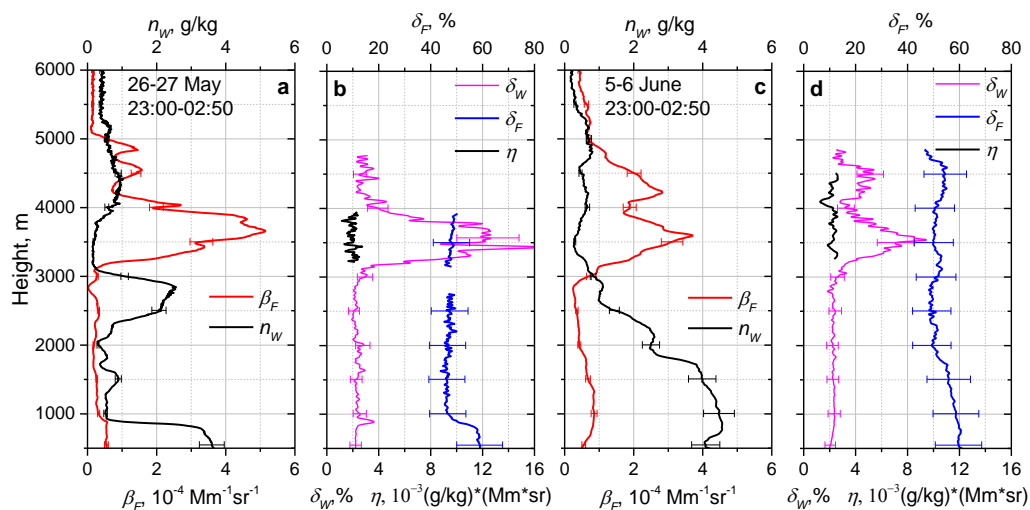

655

656 Fig. 13. Fluorescence measurements in Lille on the night 26-27 May and 5-6 June 2023. (a, c)
 657 Vertical profiles of the fluorescence backscattering β_F , the water vapor mixing ratio \tilde{n}_W , (b, d) the
 658 depolarization ratio of water vapor Raman signal $\tilde{\delta}_W$, the fluorescence depolarization ratio δ_F and
 659 parameter η , describing contribution of fluorescence to the water vapor channel.
 660

661



662

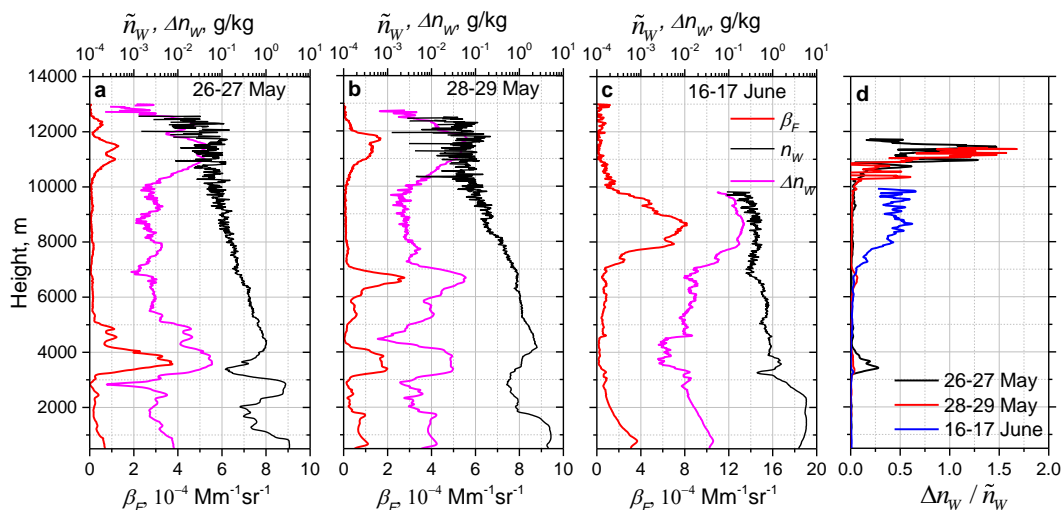

663

664

665

666

667

668

669

Fig.14. Impact of smoke fluorescence on the water vapor measurements. Vertical profiles of fluorescence backscattering β_F , water vapor mixing ratio \tilde{n}_w and bias in water vapor channel Δn_w provided by the fluorescence of smoke for episodes on the nights (a) 26-27 May, (b) 28-29 May and (c) 16-17 June 2023 for time interval 21:00-02:30 UTC. (d) Error $\frac{\Delta n_w}{\tilde{n}_w}$ introduced by smoke fluorescence for three episodes.