



HAL
open science

SP4GATEWAY: a Space Plasma Physics Payload Package conceptual design for the Deep Space Gateway Lunar Orbital Platform

Iannis Dandouras, Pierre Devoto, Johan de Keyser, Yoshifumi Futaana, Ruth Bamford, Graziella Branduardi-Raymont, Dragos Constantinescu, Jean-Yves Chaufray, Jonathan Eastwood, Marius Echim, et al.

► To cite this version:

Iannis Dandouras, Pierre Devoto, Johan de Keyser, Yoshifumi Futaana, Ruth Bamford, et al.. SP4GATEWAY: a Space Plasma Physics Payload Package conceptual design for the Deep Space Gateway Lunar Orbital Platform. 22nd EGU General Assembly, May 2020, Online, Unknown Region. pp.id.10565, 10.5194/egusphere-egu2020-10565 . insu-04419058

HAL Id: insu-04419058

<https://insu.hal.science/insu-04419058v1>

Submitted on 30 May 2024

HAL is a multi-disciplinary open access archive for the deposit and dissemination of scientific research documents, whether they are published or not. The documents may come from teaching and research institutions in France or abroad, or from public or private research centers.

L'archive ouverte pluridisciplinaire **HAL**, est destinée au dépôt et à la diffusion de documents scientifiques de niveau recherche, publiés ou non, émanant des établissements d'enseignement et de recherche français ou étrangers, des laboratoires publics ou privés.



Distributed under a Creative Commons Attribution 4.0 International License

SP4GATEWAY:

A Space Plasma Physics Payload Package conceptual design for the Deep Space Gateway Lunar Orbital Platform

Iannis Dandouras, Pierre Devoto, Johan De Keyser, Yoshifumi Futaana,
André Laurens, Julien Forest, Arnaud Trouche, Sébastien Hess, Jean-Charles Mateo-Vélez,
Ruth Bamford, Graziella Branduardi-Raymont, Dragos Constantinescu, Jean-Yves Chaufray,
Jonathan Eastwood, Marius Echim, Benjamin Grison, David Hercik, Anna Milillo, Rumi Nakamura,
Lubomír Přech, Elias Roussos, Štěpán Štverák,
Josef Winter, Matt G. G. T. Taylor,
and the SP4GATEWAY team

ABSTRACT

The Deep Space Gateway is a crewed platform that will be assembled and operated in the vicinity of the Moon by ESA and its international partners in the early 2020s and will offer new opportunities for fundamental and applied scientific research.

The Moon is a unique location to study the deep space plasma environment, due to the absence of a substantial intrinsic magnetic field and the direct exposure to the solar wind, galactic cosmic rays (GCRs) and solar energetic particles (SEPs). However, 5-6 days each orbit, the Moon crosses the tail of the terrestrial magnetosphere facilitating the in-situ study of the terrestrial magnetotail plasma environment as well as atmospheric escape from the ionosphere. When back outside of the magnetosphere, a variety of these and other phenomena, e.g. those driving solar-terrestrial relationships, can be investigated through remote sensing using a variety of imaging techniques. Most importantly, the lunar environment offers a unique opportunity to study the interaction of the solar wind and the magnetosphere with the lunar surface and the lunar surface-bounded exosphere.

In preparation of the scientific payload of the Deep Space Gateway, we have undertaken a conceptual design study for a Space Plasma Physics Payload Package onboard the Gateway (SP4GATEWAY). The main goal is first to provide a science rationale for hosting space plasma physics instrumentation on the Gateway and to translate that into a set of technical requirements. A conceptual payload design, that identifies a strawman payload and is compatible with the technical requirements, is then put forward. The final outcome of this project, which is undertaken following an ESA AO, is an implementation plan for this space plasma physics payload package.

Moon space plasma environment

**During 21 – 22 days every Lunar orbit
the Moon is directly exposed to the Solar wind**

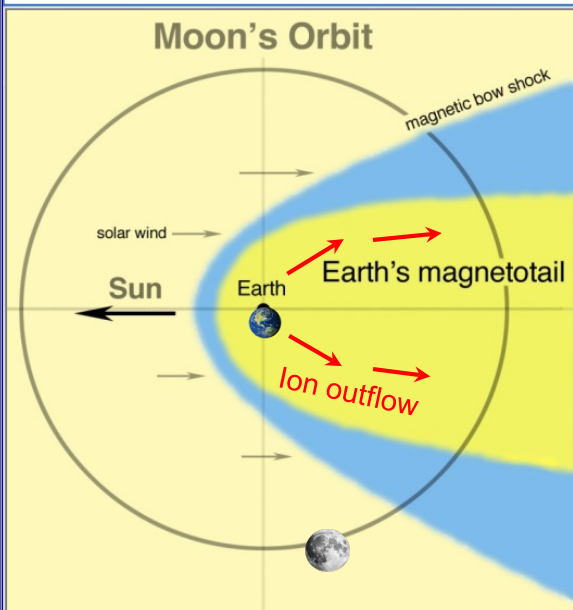

Due to the absence of a substantial magnetic field, it is then exposed to:

- **Solar Wind :** ~keV
- **Solar Energetic Particles (SEPs):** ~MeV
- **Jovian Energetic Electrons :** ~MeV
- **Galactic Cosmic Rays (GCRs) :** ~GeV

The Moon's vicinity, during these periods, is typical of deep space

**During the remaining 5 – 6 days of
each Lunar orbit
the Moon gets within the
terrestrial magnetotail**

Moon exposed then to the terrestrial magnetotail plasma environment:

- **Plasmoids** released from the near-Earth magnetotail
- **Bursty bulk flows (BBFs)**
- **Magnetic reconnection**
- **Plasma sheet dynamics**
- **Ion outflow from the terrestrial ionosphere**

Lunar exosphere

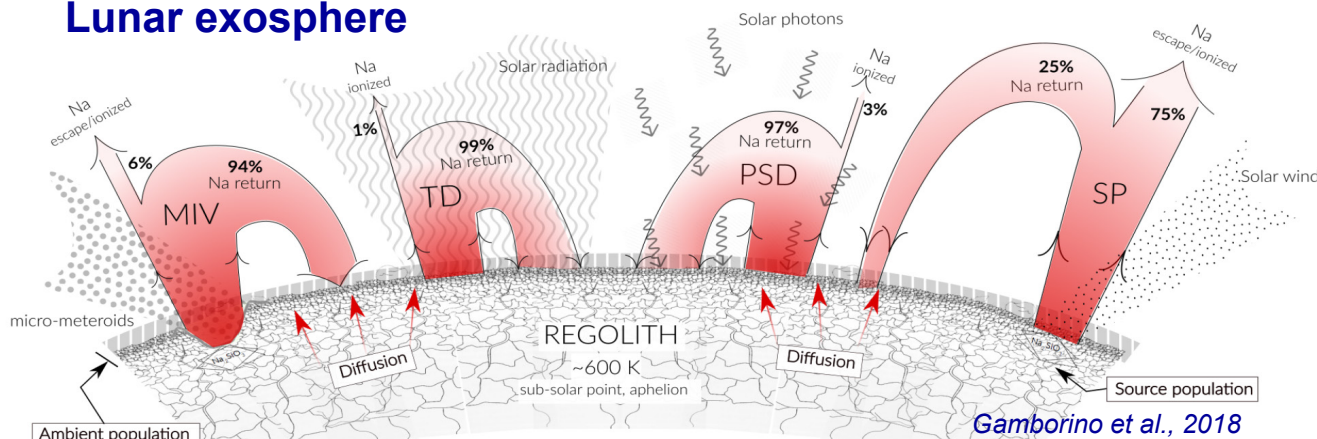

**Regolith – exosphere - space environment:
a complex multi-scale system**

Deep Space (or Lunar Orbital Platform) Gateway

- ❑ **Crewed platform** that will be assembled (2022 – 2028) and operated in the vicinity of the Moon by NASA, ESA, Roscosmos, JAXA and CSA.
- ❑ Will offer new opportunities for **fundamental and applied scientific research**.

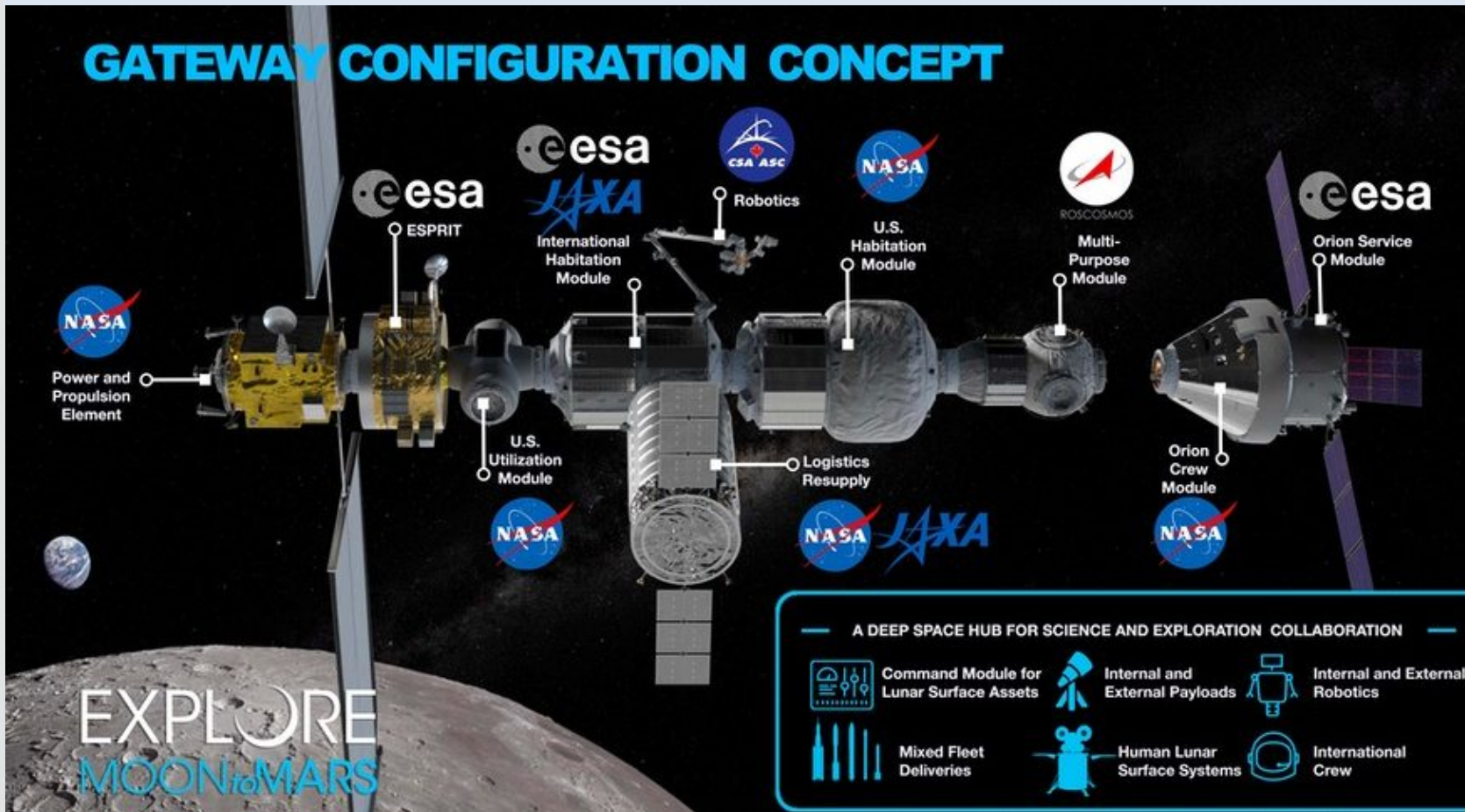

In preparation of its scientific payload, **ESA** set up international **science teams** to prepare and to support the definition of **payload studies**, including a **topical team** in the field of **space plasma physics**.

Science Objective	Measurement Requirement <i>Short Term</i>	In-situ Meas. Instrument	Remote Sensing Instrument
Monitor solar wind as a driver for the dynamics of terrestrial magnetosphere, terrestrial & lunar exospheres, lunar surface sputtering & charging	Solar wind density & transport velocity $1 - 10^2 \text{ cm}^{-3}$, 200 – 1000 km/s	Faraday Cup Electrostatic Analyser	-
	IMF: 10 000 nT instrument range 1 nT / 0.1 nT absolute/relative resol.	Magnetometer	-
Monitor & characterise SEPs & GCRs for rad. environment & as lunar surface sputtering sources	40 keV – 100 MeV ions (SEPs) up to ~5 GeV (GCRs) 500 MeV / nucleon for composition	Energetic particle detectors	MeV ENA Imager
Monitor and characterise the response of the terrestrial magnetosphere to the solar wind with a wide coverage of geospace	Detect and image solar wind charge exchange X-rays (0.2 – 2.0 keV), FOV $10^\circ \times 10^\circ$, angular resolution: $0.3 R_E$ from the Moon		Soft X-ray Imager ENA Imager
Monitor solar wind interaction with lunar exosphere, regolith & magnetic anomalies	Detect and image low-energy ENAs, 0.1 – 10 keV, $30\% \Delta E/E$, $\sim 5^\circ$ resol. Strong UV suppression: 10^{-8}		LENA imager
Reveal the solar wind ion dynamics in the vicinity of the lunar magnetic anomalies	Detect and image low-energy ENAs, 0.01 – 3 keV, $30\% \Delta E/E$, $\sim 5^\circ$ resol., FOV $\sim 5^\circ \times 120^\circ$		LENA imager
Monitor the terrestrial & lunar exospheres, plasmasphere	Detect and image EUV emissions 30.4, 83.6, 121.6 & 130.4 nm ~ 5 arcmin resol.		UV / EUV spectro-imager
Monitor ambient plasma in different environments (solar wind/magnetosheath/terrestrial magnetotail/lunar wake)	Plasma density & temperature $10^{-4} - 10^2 \text{ cm}^{-3}$	Langmuir probe	
	Magnetic field: 10 000 nT range 1 nT / 0.1 nT absolute/relative resol.	Magnetometer	

SP4GATEWAY: Space Plasma Physics Payload Package Conceptual Design for the Gateway

- ❑ Translate the **science rationale** for space plasma physics instrumentation into a set of **technical requirements**.
- ❑ **Simulate** the Gateway – plasma environment interaction.
- ❑ **Conceptual payload design**, that identifies a **strawman payload** and is compatible with the technical requirements.
- ❑ Instruments grouped in terms of **accommodation & pointing requirements**
(Sun / Earth / Lunar pointing, fixed mounting or on a pointable 1-axis rotation platform).
- ❑ The final outcome of this project, which is undertaken following an ESA AO, will be an **implementation plan for this space plasma physics payload package**.

Gateway Phase 2: 2024 - 2028

US-Hab: *US Habitat*

International-Hab: *International Habitat*

HALO: *Habitation and Logistics Outpost*

PPE: *Power & Propulsion Element*

LM: *Logistics Module*

HLS: *Human Landing System*

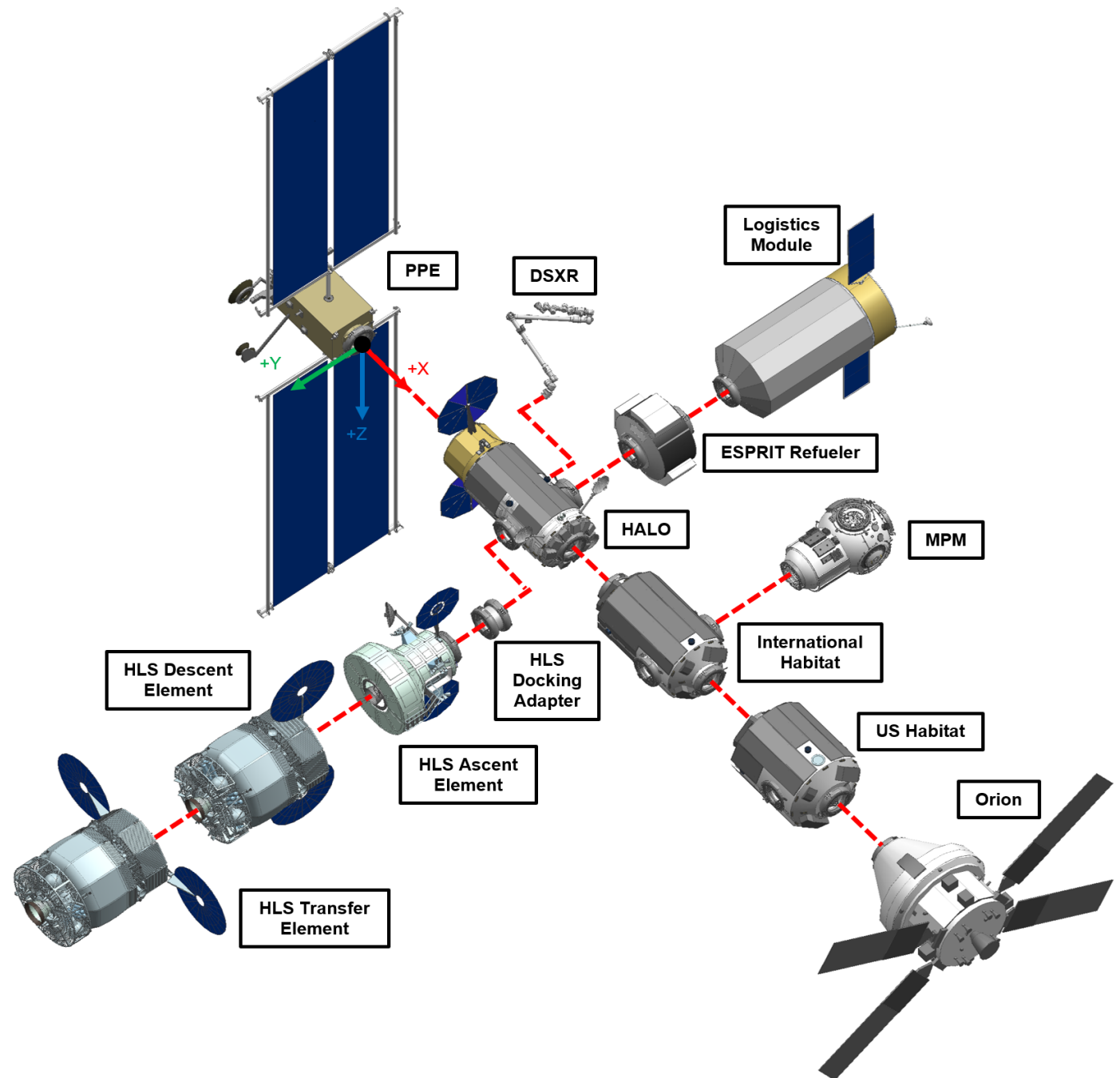

Deep Space Gateway: Orbit

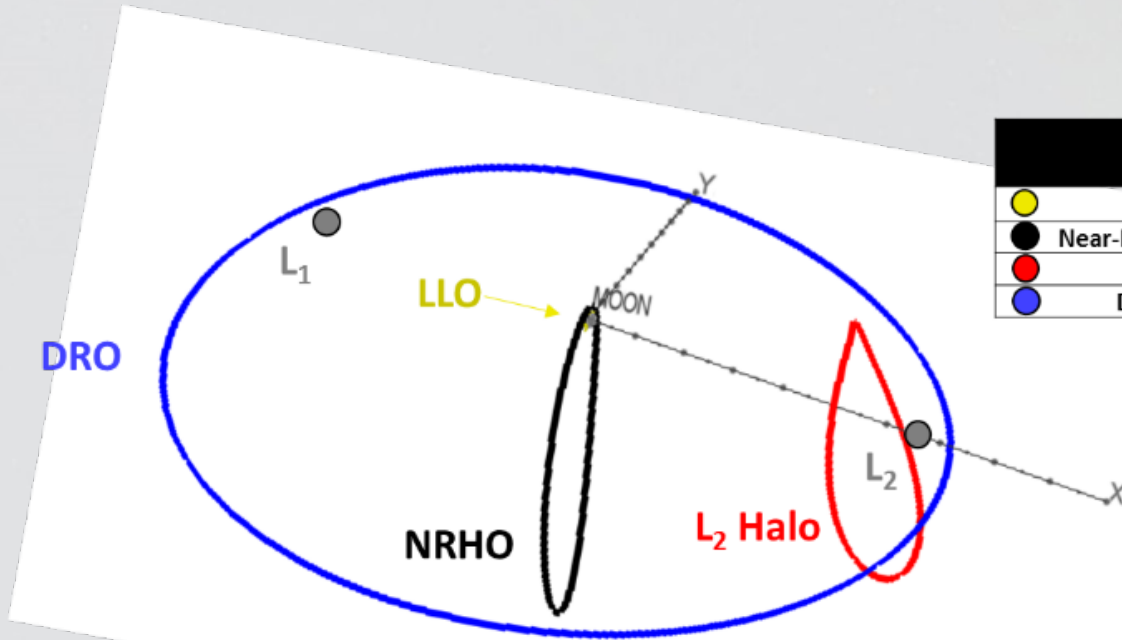

Orbit Type	
●	Low Lunar Orbit (LLO)
●	Near-Rectilinear Halo Orbit (NRHO)
●	Earth-Moon L ₂ Halo
●	Distant Retrograde Orbit

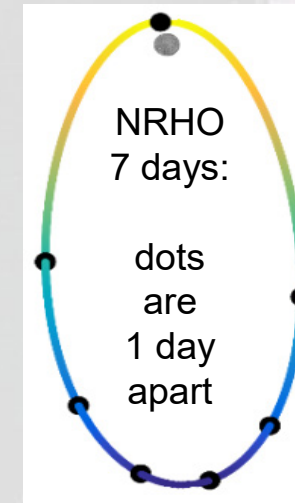

Orbit	Property	Value
Near Rectilinear Halo Orbit (NRHO)	Period	≈6.5 (Earth) days
	Orbit around	Moon
	Periapsis × Apoapsis	≈3 200 × 70 000 km
	Inclination	≈90°
	Earth visibility	Constant
		9:2 resonance with the lunar synodic period

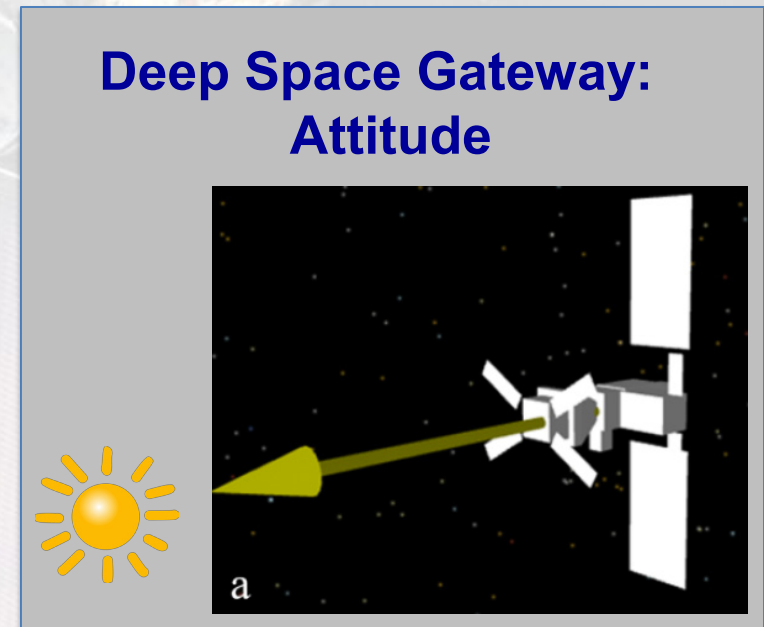
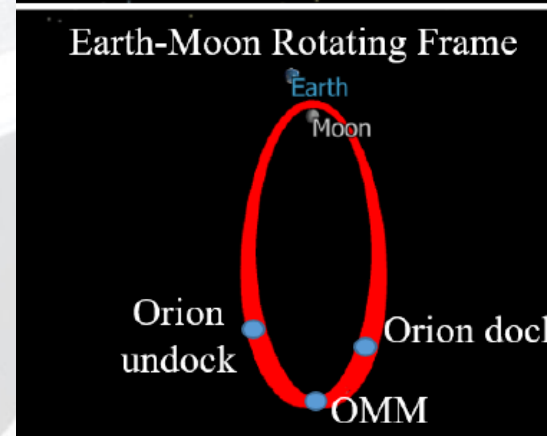
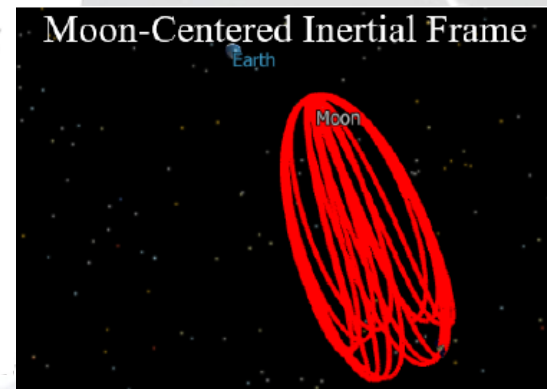

Simulation of the Gateway – plasma environment interaction

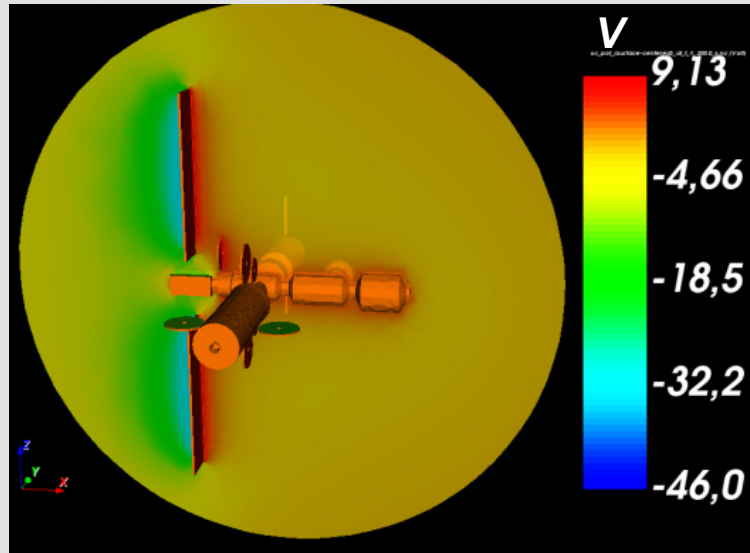

Electrostatic potential simulation
in the solar wind

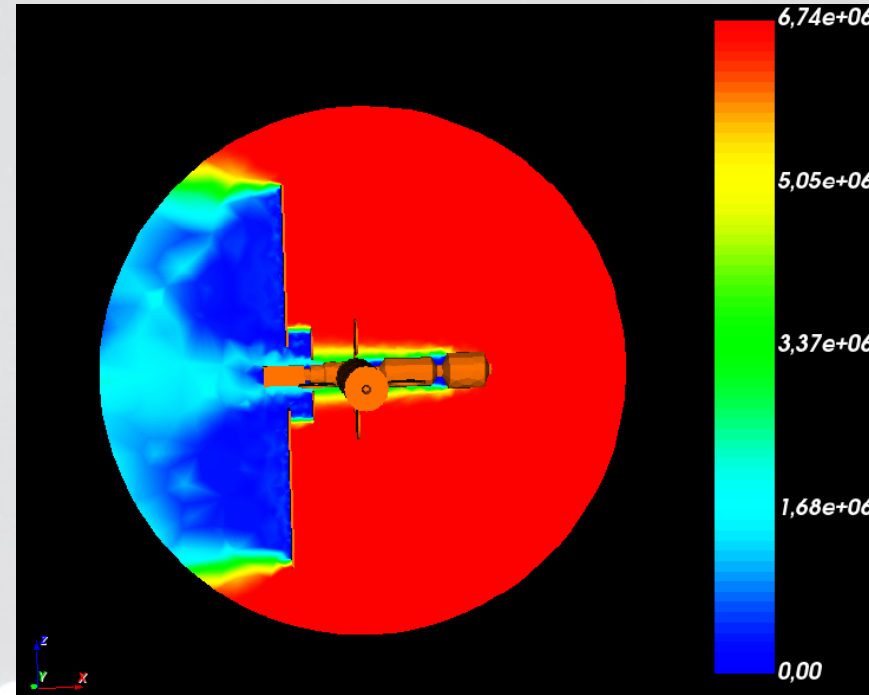

Ambient proton density (m^{-3})
in the solar wind

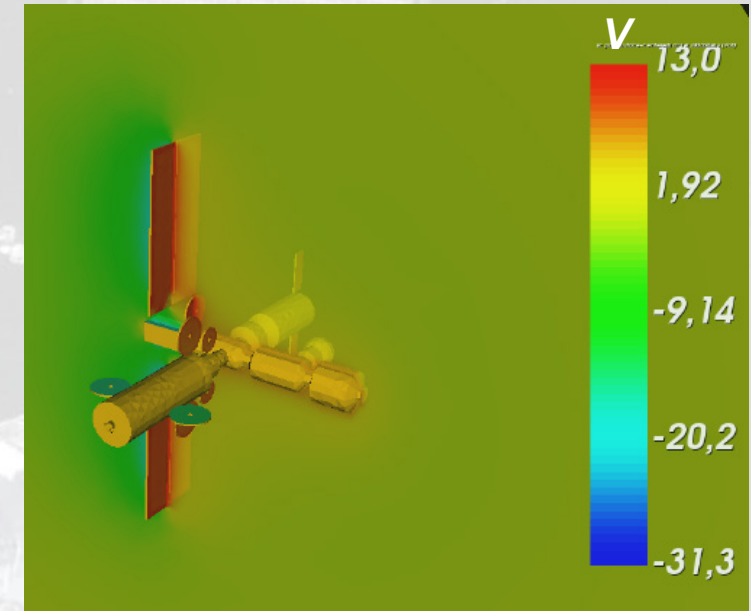

Electrostatic potential simulation
in the magnetotail

Identification of the most favourable positions for the plasma instruments

Remaining positions can then be used for energetic particle & magnetospheric imaging instruments

Preliminary space plasma physics instrumentation conceptual design

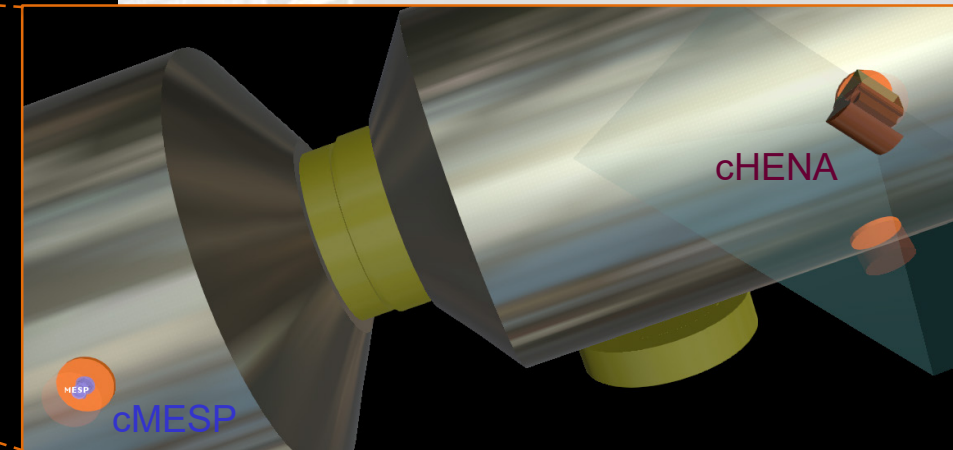
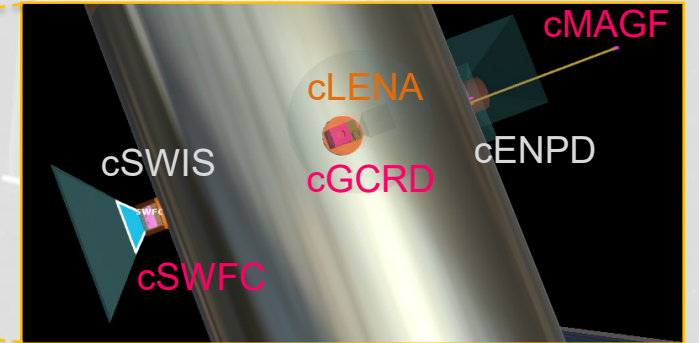
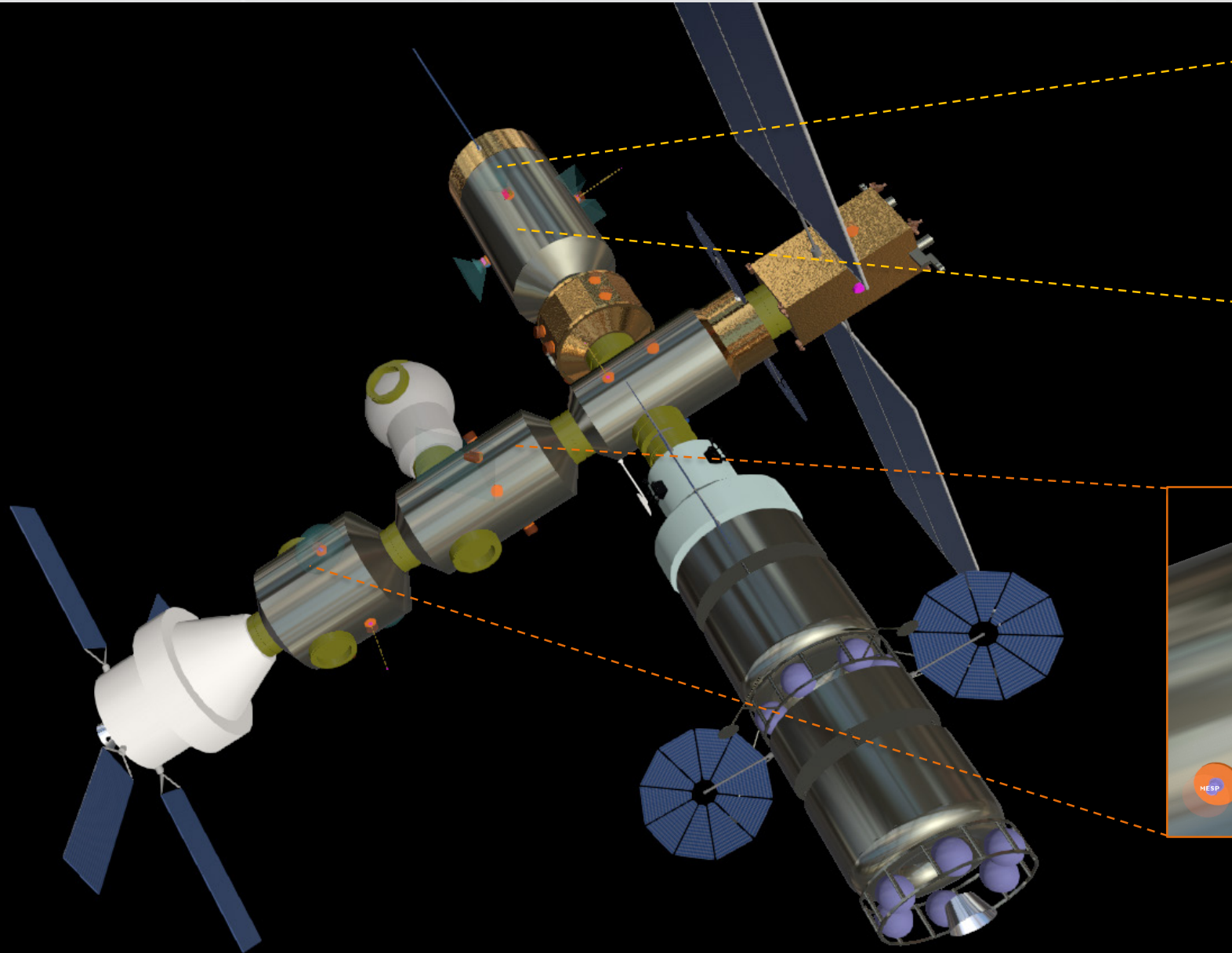

Work in progress...

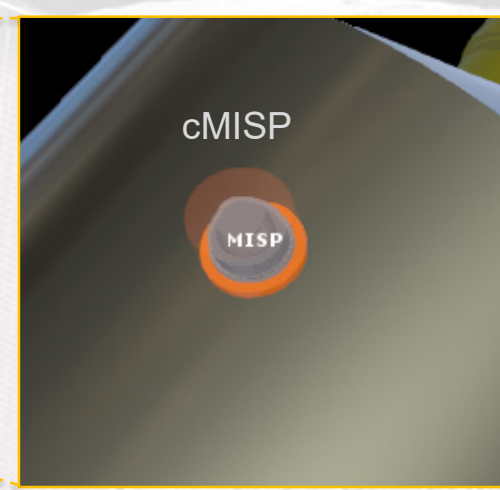
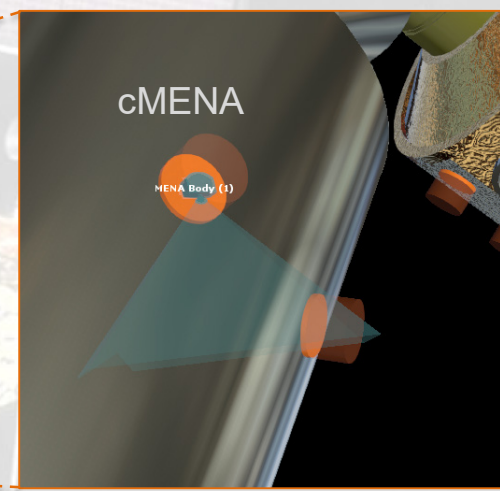
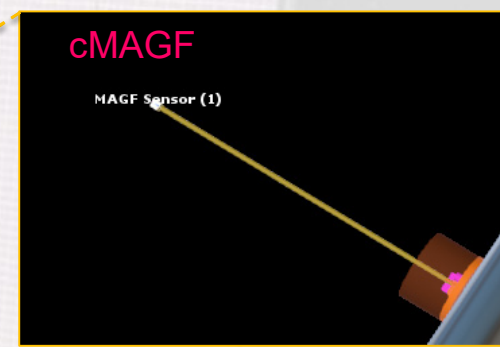
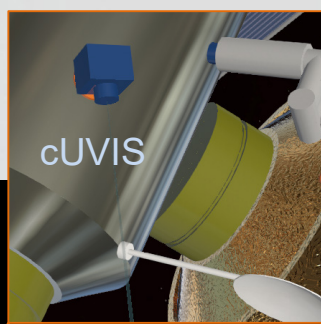
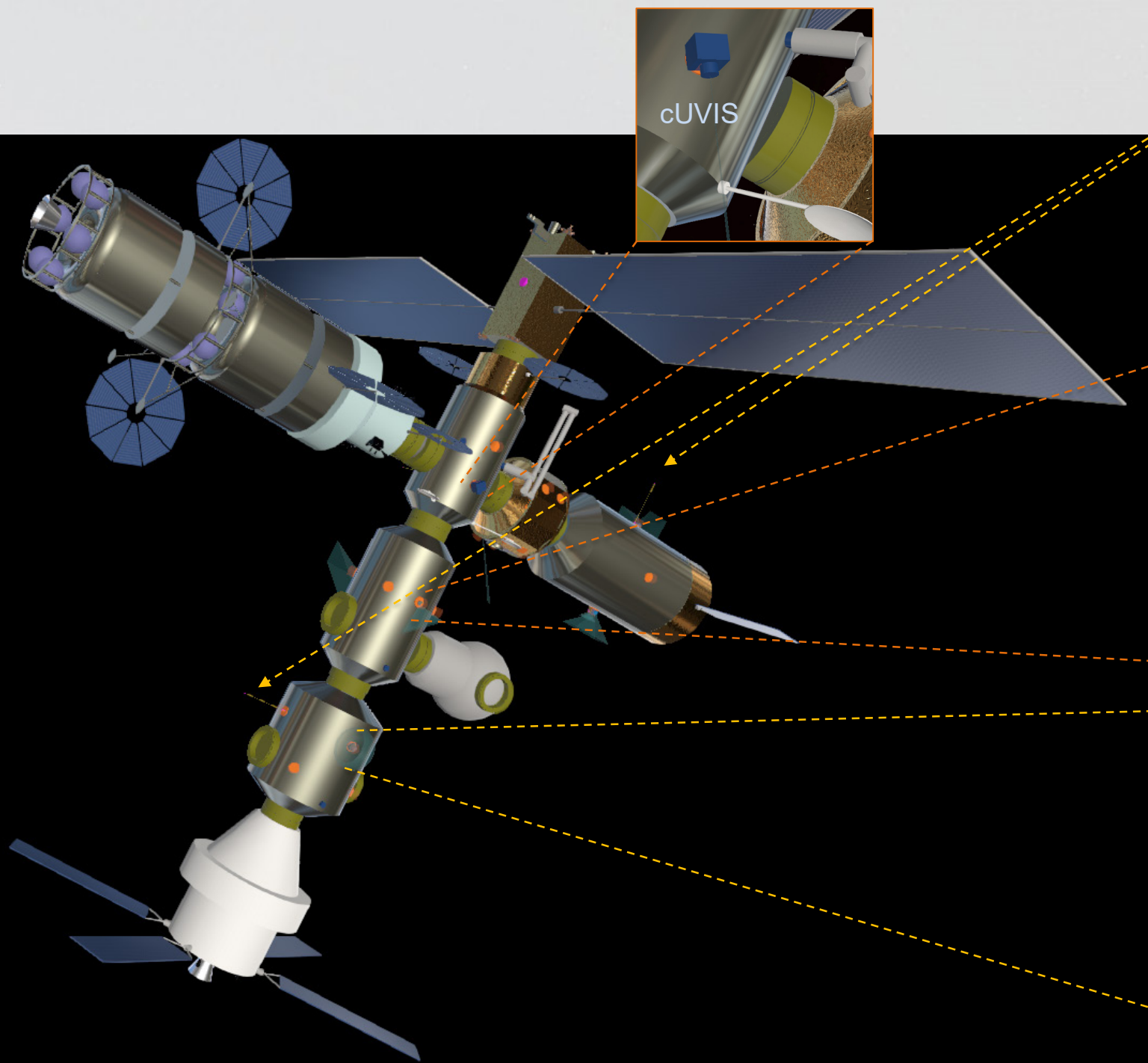

Instrument Fields-of-View (FOV) / Fields-of-Regard (FOR) along the Gateway Orbit

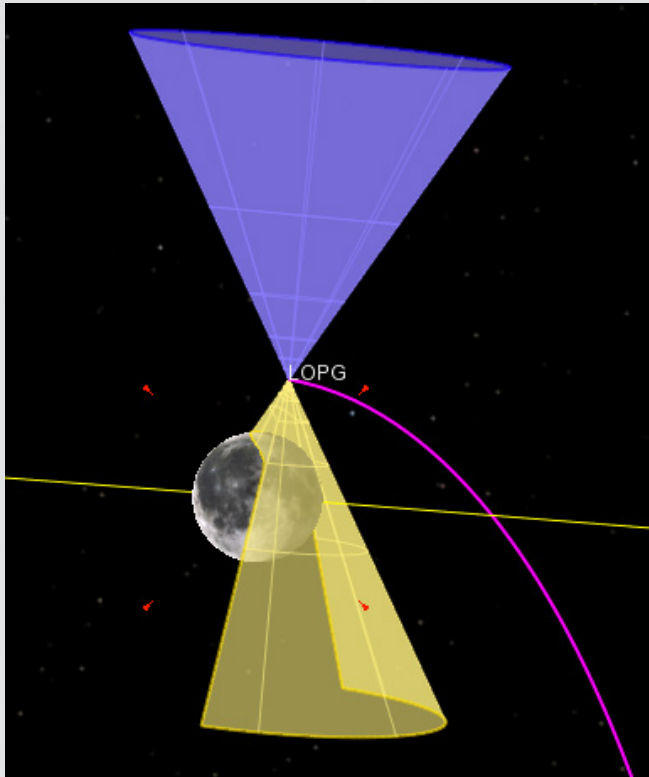

cENPD FOVs near periapsis:

- Pristine energetic particles flux (purple FOV)
- Moon albedo energetic particles flux (yellow FOV)

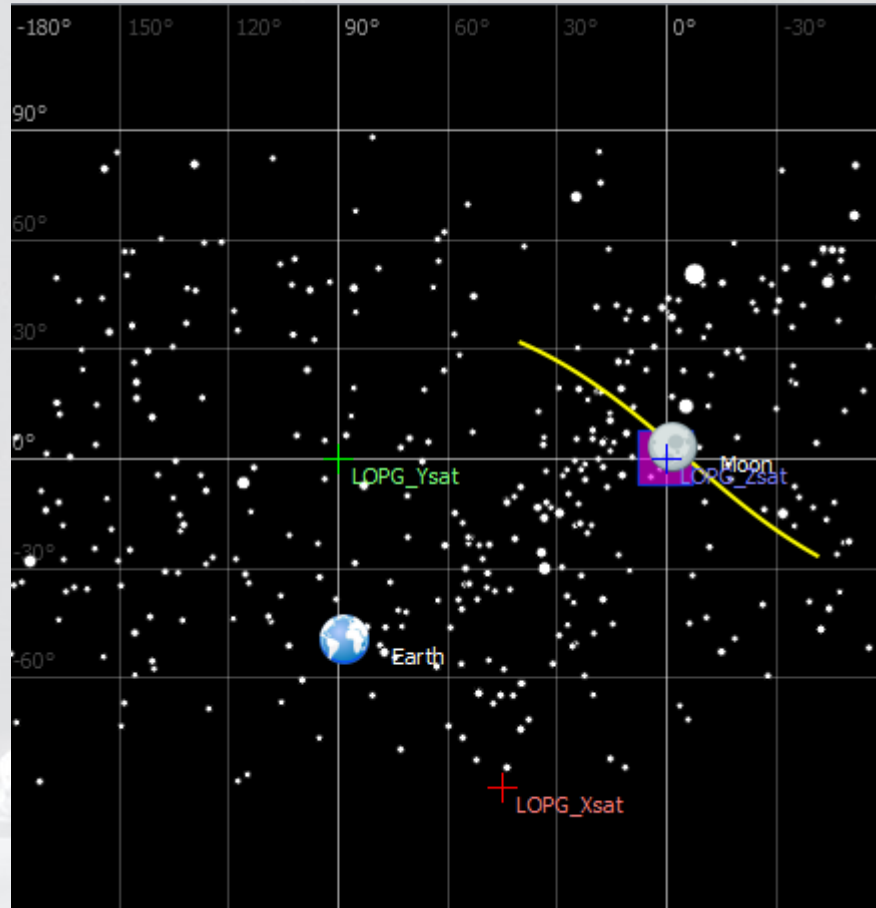

cLENA instantaneous FOV (in magenta) near periapsis. Yellow line: track of the centre of the FOV, for the portion of the orbit close to periapsis, as projected on the sky.

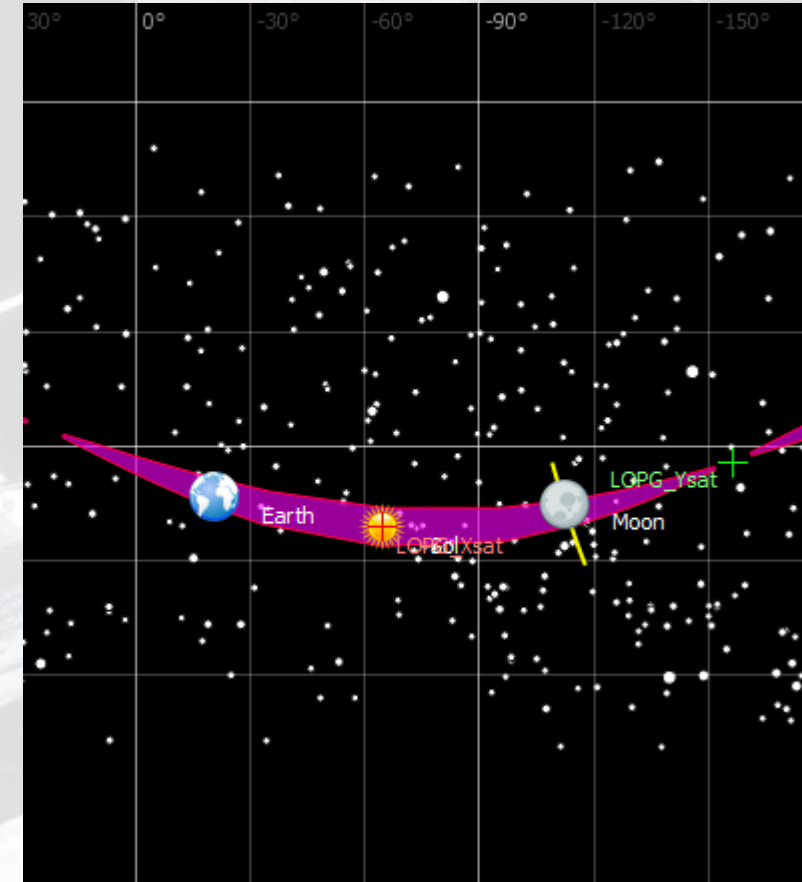

cMENA instantaneous FOR (total accessible FOV, using the 1-axis rotation platform), in magenta, as projected on the sky.

- *The Deep Space Gateway Lunar Orbital Platform is well-suited for space plasma physics research*
- *Conceptual design for a Space Plasma Physics Payload Package, under an ESA study*

